

# Earth First! Direct Action Manual



Third Edition





# Earth First! Direct Action Manual

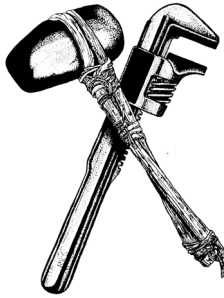

Third Edition

# »»»TABLE OF CONTENTS

<b>DOING THE DAM THING</b>	<b>4</b>
<b>STAYING SAFE</b>	<b>8</b>
Security Culture	9
Electronic Security	21
Eco-Liberation	27
<b>HOW TO DO IT</b>	<b>32</b>
Anatomy of an Action	33
Research	43
Scouting	48
Communications	52
Action Media	57
Action Legal	64
<b>SOUND OF THE POLICE</b>	<b>72</b>
Know Your Rights	73
Prisoner Support	85
Police Intimidation & Torture Tactics	91
Yo! What's with the Cops?	97
Understanding Police Tactics	
<b>GROUND BLOCKADES</b>	<b>102</b>
Body Blockades	103
U-locks	107
Cobra Link Motorcycle Locks	111
Chains and Cables	112
Lockboxes	113
Superboxes	120
Bracelets	123
Barrels	125
Batmobiles	130
Sleeping Dragons	134
Tunneling	139
<b>AERIAL BLOCKADES</b>	<b>140</b>
Tripods	141
Bipods	153
Monopods	159
Cantilevers	165
Skypods	169
Aerial Blockade Evictions	176
Tree Entry	178

Treesits and Platform Rigging	184
Rigging Traverses and Internets	194
<b>CLIMBING BASICS</b>	<b>198</b>
Climb Training Orientation for Beginners	199
Ascending, Descending, and Traverses	
Anchoring, Rope Strengths, Physics, and other Technical Insights.	213
Moving Mountains	225
<b>A LITTLE BIT COUNTRY</b>	<b>230</b>
The Art of Holding Space	231
Backwoods Actions	241
Cat and Mouse	248
Hunt Sabotage	250
Direct Aid as Direct Action	253
Action Camps	256
<b>YOU'RE GONNA LOCK TO WHAT?</b>	<b>260</b>
Rail Blockades	261
Ship Blockades	267
Helicopter Blockades	269
Banner Hangs	271
Billboard Occupation and Alteration	274
Tin Foil Hats	279
<b>DOUBLE DARE YOU</b>	<b>282</b>
A Paperwrencher's Toolbox	283
Making Life Hell	290
Pranks	295
Paint Bombs	300
Misc. Deviltry	303
<b>CONCLUSION</b>	<b>310</b>
<b>GLOSSARY OF TERMS</b>	<b>312</b>
<b>KNOTS</b>	<b>317</b>
<b>CONTACTS AND RESOURCES</b>	<b>320</b>
<b>DIRECT ACTION TRAINING OUTLINE</b>	<b>322</b>

# >>> DOING THE DAM THING

## **EARTH FIRST! IS A LEGACY**

As the staggering forces of greed push consumerism and the wholesale destruction of the Earth to unheard of levels, people across the planet are fighting back. Time is indeed running out, and what else can be done but build the bonds of friendship, fly a flag of resistance, and fling the nearest wrench into the grinding gears of capitalism? Although we are eager for instant earth liberation and an end to all hierarchies, the tactics in this book have developed out of long-term struggle, over the 30+ years that Earth First! has been resisting, and extending far beyond that from the many movements we have drawn skills and inspiration from.

With your hands and hearts in this book, you inherit a rich history. Those who forged the Earth First! name left environmental activist groups with a searing critique of reformist movements and the non-profit industry. Three tenets continue to bind the Earth First! movement today: biocentrism—the belief that all life on the planet is intertwined and holds intrinsic value, direct action—making change that is unmediated by the political process, and no compromise—the complete refusal to make a deal or sell out the groups we work with or the land we aim to defend.

Earth First! has a relatively unbroken history, with elders who have been in resistance for decades and more than thirty years of annual summer and winter gatherings, a consistent journal to communicate with one another, and direct action campaigns where we build our strength and skillsets together. This is rare in our transient society, where the government strategy to pacify resistance movements is to divide communities to disable their collective memory, and recuperate their struggles into something safe—like how the militant struggle of the civil rights movement has been erased and replaced with an MLK Blvd in every city. Other spaces of historical continuity can be found in indigenous communities in resistance and struggles that are similarly rooted in geographical place.

With three decades of struggle by troublemakers of all types, however, you also inherit a legacy of problems. Coming out of the typically white male dominated environmental movement, Earth First! has struggled with an outdoorsy machismo, overt and subtle racism, cultural appropriation, and a refusal to prioritize relationships with indigenous communities and environmental justice groups. Slowly, we have been

learning from our collective successes and failures, and with every new project, we transform ourselves a little as we aim to transform the world around us.

### **EARTH FIRST! IS A BRIDGE**

Earth First! exists simultaneously in multiple worlds. Repping the power of strategic civil disobedience while publicly pushing for the necessity of sabotage and all kinds of other earth-defending, civic-minded crimes, it's no surprise that you can find Earth First!ers both giving workshops and lectures at environmental conferences and running in the streets at mass mobilizations. This approach to direct action, one that encourages people's participation at all levels through a diversity of tactics, opens space for those who may only be beginning to be curious about civil disobedience. In this way, Earth First! has often been an entry point for those from the environmental movement and other places who are fed up with the political process and want to develop their direct action skills.

With its proximity to big, reform-minded environmental organizations—or radical grassroots organizations with a narrow analysis—Earth First! brings a focus on biocentrism, which obviously lends itself to a decolonizing perspective and a critique of civilization as a whole. With its emphasis on decentralized and non-hierarchical organizing, Earth First! also intersects with anarchist movements—which are organizing towards social insurrection for the destruction of civilization as we know it, and the liberation of the Earth and all its animals. To the nihilism embedded within anarchy, EF! brings a warmth of heart, a connection to place, and a nourishment that isn't accessible in modern society.

EF! has grown from a movement focused primarily on actions in the wilderness and rural settings, to organizing in a broader spectrum—planning actions in urban and industrial areas, as well as a continuing defense of the wild. Offices, factories, financial institutions, and the policing structures that protect them all play a key role in the destruction of the planet. The global struggle against the forces of extraction, exploitation, racism, and patriarchy are being fought in every city, village, and wild place on earth, and a true victory will only come as a death from a thousand cuts, as innumerable communities and groups battle the many headed hydra known as capitalism.

### **EARTH FIRST! IS AN IMPERATIVE**

When we move through the world with proper urgency of what must be done, time slows down for us. Thirteen years have passed since the second edition of the Direct Action Manual was released, and so much has changed. We have done so much, and the state has retaliated



fiercely, crafting new technology and legislation for surveillance and repression, and killing and imprisoning many dear friends and strangers in the struggle, in an attempt to silence, isolate, and pacify. And yet, revolution is on the upswing.

With growing public attention around resistance to mega infrastructure projects and increasingly dirty energy extraction on this continent, not to mention intensifying uprisings around the globe responding to economic and ecological crises from Dhaka to Istanbul, from Tunis to Sao Paulo, and beyond, protests and rebellions are at their highest frequency and intensity in the last thirty years. We are living in a moment of possibility, and we must act quickly before the window closes.

Time is running out, and yet when you look around the room (or base camp) to see loved ones you'll be plotting resistance with for a lifetime, when you know the changes of the riverways, the pattern of the procession of the blossoming of flowers, the best places to find nuts to nourish, bark to weave and the medicine to heal, time seems immaterial. There is more to do than anyone can imagine, and yet we will continue to build our fighting spirit and adapt.

And so, as a gift to all those in struggle, we humbly offer this manual, in hopes that it will contribute to the continued growth of direct action as a viable tactic in defense of the earth and its inhabitants. Some of the tools in this book have come directly from the front lines of forest defense while others find their roots in places like mass actions or local housing struggles. While by no means exhausting the possibilities of dissent, this is the guide version of how we got started.

One of the things that hasn't changed at all since the second edition is that these tactics are always under development. Take these ideas and make them yours. Create fearsome new constructions and unpredictable combinations, then teach us how! You don't have to be an Earth First!er to use this manual, but we'd love to hear your stories of success and lessons learned.

With love and rage and anarchy,  
For the Wild,

**- THE DAM COLLECTIVE**





**STAY SAFE**

*Treesitters block construction of the Kesytone XL pipeline in TX, 2012*

# >>> SECURITY CULTURE

A security culture is a shared set of customs and communication designed to safeguard individuals and communities engaged in public political organizing and/or illegal activity. Practicing good security culture minimizes the risks of state repression and retaliatory violence, helps to avoid unhealthy paranoia, and clarifies expectation about communication to avoid the alienation of new comrades. It's the way we protect ourselves from infiltration, surveillance, and prison, so we can continue organizing with less fear.

Popular consciousness about environmental issues has seen tremendous growth in the past few years, yet people organizing or speaking out against environmental degradation in this country and abroad have been facing escalating patterns of harassment. In 2002, at a time when the government was using “defense from terrorism” as an excuse to further their programs of surveillance, militarization and control, the FBI announced the Earth Liberation Front —ELF—and Animal Liberation Front—ALF—groups that have never injured another person and have only caused damage to property in political protest—as the number one domestic terrorist threat, and this was reaffirmed in 2008. This should clarify the true aims of the government’s defense programs: to defend property and capital at all cost and to create the illusion of a civil peace.

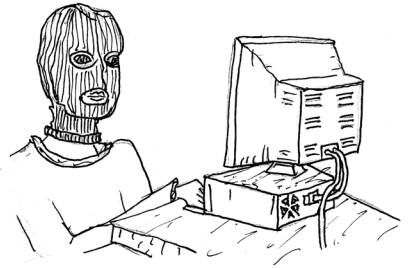

Because our movements for the liberation of the Earth and all its animals build power through people taking direct action, it shouldn't come as a surprise that the corporate/government power structure works in turn to disrupt and undermine grassroots movements under the guise of fighting crime. State and Federal governments continue to create new surveillance programs and laws criminalizing dissent, crafting legislation first applied to the most marginalized communities, then extended to political dissidents from a variety of socio-economic backgrounds. If it wasn't already apparent that the liberation of the earth is bound up with our collective social liberation, this further illustrates why we have to organize in active solidarity with others, especially across race and class lines.

The state's strategy in maintaining the status quo and suppressing revolutionary movements such as the Black Panther Party, American

Indian Movement, and Earth First! has always been one of violent harassment and intimidation, but we can learn from these potent histories. We can adopt anti-snitching sentiments from groups like the Black Liberation Army that still thrive today in street gang culture, and we can learn from the ways the Black Panther Party became especially susceptible to the government's COINTELPRO program because of unresolved conflicts around misogyny and domination within their organizing. We can also see the importance of individual and movement connections to the radical left—that has access to more social and financial capital—through the legal defense efforts of Green Scare defendants, such as Daniel McGowan.

From the infiltration of the Arizona 5 in 1989, to the success of the Operation Backfire case against courageous eco-arsonists in 2005, and from cases like those of long-term anarchist prisoners Eric McDavid and Marius Mason, we can begin to identify some common factors in these greenscare cases, all of which were made possible in some way due to cooperation with the state. Despite that, according to the feds, there are over a thousand claimed, unsolved ELF actions currently in the US alone. Which reminds us that often the police don't have hard forensic evidence to indict someone on specific charges, but they rely heavily on people snitching, paid informants, and entrapment. Because we are living in a time of unprecedented surveillance and heightened repression against social movements in the US, it is of crucial importance that we learn our history, understand the risks, and prioritize safety in our organizing without encouraging overly complicated or fear-inducing protocols.

## **THINKING IT THROUGH**

Building practices of general security culture with those we live and organize with creates a context that broadly increases our safety and opens a safer container for communication about specific sensitive topics. Creating subcultural norms can seem alienating at first, but transparency about why we act the way we do can invite people into this resistance culture and give folks the agency to intelligently devise new cultural customs for staying safe.

Foremost, arm yourself with trust in your own instincts. Develop active listening, mental recall, and perception skills. Maintain clear and honest communication within your affinity group, and establish processes to deal with internal group issues as well as with outside harassment and intimidation. So often we find ourselves caught up in the stress of everyday organizing and the fear that they are after us, that we alienate new people out of distrust. Get to know people and gradually extend your relationship with them; honor people's efforts to get involved with just as much respect and humility as caution.



It's important to realize that security culture is not about simply following an activist check list. Action names can be helpful, and encryption is useful for obscuring social connections, but these can also create a dangerous false sense of security. If you are intending on committing serious actions with people, it's important to know them well—know them for a good length of time, know where they come from, understand how they make money, know people's families if they have them. If you're working with people with kids, have open conversations about the risks of the state intervening through CPS or otherwise putting on pressure through threats to the children.

Remember that Federal investigations go on for years, and FBI agents will still be attempting to solve cold cases, even after many activists have “moved on” or “grown up.” Consider where your comrades will be in a decade or more. Many of the Operation Backfire defendants who cooperated with the state were no longer connected to resistance movements when the felony indictments came out, and they had lost their incentive to protect their friends. Also watch for subtle signs of abusive or manipulative behavior and histories with drug addiction or lying. The main Operation Backfire snitch cooperated with police to get out of pending drug charges, and there are countless other similar stories. Many who survived the COINTELPRO repression of the '60s and '70s stress how the feds played on people's drug addictions and unresolved internal conflicts connected to race, gender, and power to push people into informing on their comrades.

Be careful, also of the dangers of pillow talk—the legal implications of sharing too much with sexual partners. Just because you share your bed, tent, hammock or wild foraged primitive shelter with someone, doesn't mean you need to keep them informed about every aspect of your organizing. While it is crucial to be open and honest in radical relationships, it is also important for each partner to respect the other's autonomy and freedom of movement. There have been countless incidents where someone's lover turned state's evidence on them—like Marius Mason's lover did—or where informants used sexuality and romance in order to entrap anarchists—like happened to Eric McDavid. Sexual trust is not equivalent to the kind of trust that is required for illegal action. Don't bring a brand new lover into your affinity group until you know them as well as the standard you would set for any other friend, and don't try to bring a sweetheart into a stressful situation that they are ill-prepared for. People are more likely to fold under pressure and cooperate with the police when they get involved in resistance to impress someone else.

## SOME BASIC AGREEMENTS FOR REVOLUTIONARY STRUGGLE

***Don't talk to the police.*** Never share information—personal, political, or otherwise—about another person without their consent, especially to law enforcement or the media. Small details that didn't seem incriminating at the time have been used to break unsolvable cases, leading to the arrests and convictions of dear comrades.



Don't think that you can outsmart the police by only giving them "unimportant information." All details are useful and can connect dots, create a social map for them to analyze, and confirm their suspicions. Assume that there is nothing that they already know. While you may be smarter than a specific cop, the feds have almost endless resources; they can record conversations and have other agents and analysts go over the data. Be smart enough to realize that the only way to avoid being caught is for no one to talk.

***Refuse to cooperate with the state.*** Often referred to as snitching, flipping, rolling, or turning states' evidence. Don't give incriminating information to the police about another person in exchange for leniency for yourself. Doing this means you will receive no movement support and will likely be ostracized from activist communities forever. Not to mention, snitches often still serve jail time and are highly unpopular among their fellow prisoners.

***Don't use security culture as an excuse for exclusivity.*** Take care to share openly when it is safe to do so, and truly keep information confidential when it is necessary. If you don't want someone to know about an upcoming action, you shouldn't mention even the possibility for a meeting in front of them. The State already does its work to make us suspicious of one another and simultaneously tries to separate us while identifying "leaders;" we don't need to reinforce anyone's feelings of a singular center of resistance that they are inside or outside of. Build an inclusive form of security culture that aims to protect and not alienate and be conscious of racialized and gendered patterns that can create an exclusive insider boy's club with disproportionate amounts of control.

***Trust your friends' silence.*** Don't share confidential information or accidentally allude to events that happened or may happen. Don't brag about illegal things or your interest in them. Don't ask others about things you don't need to know. Unnecessarily knowing about the illegal acts of your comrades puts you at risk if you are later questioned or subpoenaed. Never talk about your or others' involvement in past actions, however long ago.

Trust that you don't need to be included in everything, and that not being invited to participate in an action or a meeting about an action is not a judgement of value on your worth as a person or a friend. Don't be pushy and demand to be included always, and don't gossip about the behaviors of others when you can tell your friends are organizing something because you feel left out. Conversely, when you're organizing an action without certain friends or people in your group, take time to tell people how much you value their friendship/contributions to your organizing/reassuring presence—in a way that has nothing to do with the action.

## **ESTABLISHING STANDARDS FOR A SPECIFIC ACTION**

The essence of security culture is that information is shared on a need to know basis, but for specific actions, the key is in matching the appropriate security protocols with the task at hand. In some cases, the whole town will need to know about an action for it to be a success; in others, it will be crucial that the action is never spoken of outside of the circle of those directly involved. From the beginning of a project, operate according to the highest possible level of security it might require because you can always lower the level of caution later, but if you start out being careless you close off options you might later miss.

Unfortunately there is no magic formula to calculate the exact security protocols for a particular task. In each different scenario, even for the same tactical activity, you might differently balance the security gained through closed communication against the benefits of open communication. However, for each action, everyone organizing needs to share an understanding of what security measures are deemed necessary and respect others' needs around safety—like in any process of establishing consent among participants.

Always establish how public you want an action to be, who you'll invite or how you'll talk with people, and what technological forms are okay to communicate through or around. Learning to gauge the risks posed by an activity will help you set standards for appropriate security levels.

### ***Here's one example of a possible system of security levels for determining who to involve in an action:***

- >> Only those who are directly involved in the action know of its existence.
- >> Trusted support people also know about the action, but everyone in the group decides together who they will be.
- >> Participants are free to invite other comrades, communicating clearly that knowledge of the action is to be kept within trusted circles.
- >> Rumors of the action can be spread widely throughout the community without including names of organizers or specific details.
- >> The action is announced openly with all details included.

**Here's an example of a possible system of security levels for forms of communication about an action:**

- >> Only communicate about the action in person, when absolutely necessary, outside of the homes of those involved, in surveillance-free environments, like the woods, parks or going on walks around town. Your car is not secure and neither is the common café you hang out at, your local infoshop or community center.
- >> Discussions are held in reasonably surveillance-free environments, outside of the homes of those involved, and participants can communicate about meeting, but not about the content of the action by encrypted email or telephone
- >> Discussions can happen in homes that are not definitely under surveillance, and participants can communicate by encrypted email or neutral telephones
- >> People can speak about the action over telephone and email as long as they don't give away certain details—like who, when, and where
- >> All details may be shared publicly in person, via phone or email

**PLAN FOR THE WORST, WORK FOR THE BEST**

Be aware of all the ways your actions can be monitored or tracked: the records of surveillance cameras, the purchases you make (take cash out of a local atm and don't use credit cards or food stamps, so there's no record of your cards being used), and phone calls you make (the tracking GPS in your cell phone, the numbers you dial and the things you say), the fingerprints and DNA you leave (on the batteries in a flashlight as well as on the outside of it, the finger prints left inside latex gloves, or the hair inside of stocking caps, for example), the places you go and the people with whom you are seen. Think about the GPS in your car if you have one, and the possible GPS monitors attached by the authorities, like Rod Coronado found on his car. Be especially careful about the location of meetings, the items you throw in your trash, and the files you have on your computer. Devise codes and prepare alibis as need be.

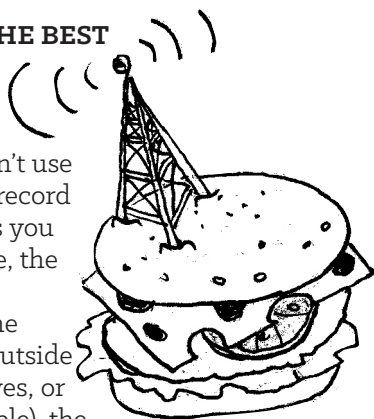

The prevalence of cell phones with cameras and video capabilities means that you have to be aware of more than just the security cameras.



Consider the implications of how you might be captured on film before, during, and after an action. Be aware of the patterns you have. Don't convene your action planning meeting in the same park or restaurant every time. Don't reconvene with your affinity group at the same diner after every action. Don't use the same excuse every time you go out to pull up survey stakes or graffiti up the city. Obvious or predictable patterns can make you a much easier target of police surveillance.

### **CAMPAIGN, HOME, OR OFFICE**

>> Back up and store important computer files and/or a copy of your hard drive off-site. Sensitive data and membership lists should be kept under lock and key—or in your head only, depending on the level of security you need. Practice good computer security measures and use an encryption program to protect your data when possible. Check out the **Electronic Security** section for more details.

>> Be careful about the political information you make public through personal internet use. Be smart about what you post about your political beliefs and actions on social media sites, from the pictures you share from your cell phone to how you describe yourself on dating websites. Social networking sites do the work of mapping out the connections between different revolutionaries for the feds. Consider not using social media to advertise all your subversive events.

>> Keep mailing and donor lists and personal phone books out of sight. Always maintain a duplicate at a different location, and update it frequently.

>> Keep a charged digital camera, or an old school camera, loaded with film, near the front door at all times to document harassment or visits from the FBI.

### **TRASH**

>> What you consider trash could be a real treasure to someone looking for information about you or your projects. Don't throw information about you or your projects in your trash.

>> Keep a burn pile in a secure place and occasionally—or often—burn it or use a shredder, but make sure your shredder creates confetti because strips can easily be reconstructed and make sure to fully burn everything because a partially burned pile of papers only guarantees that it will be considered all the more important to anyone snooping. Mixing water into the ashes can help to totally destroy any words or print left on the paper.

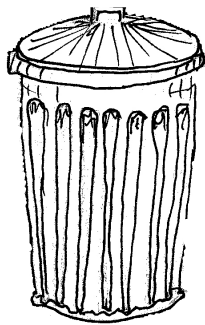

## PHONE

- >> Never say anything on the phone you wouldn't want to hear in open court. This can even include things that can be used against your character; the SHAC trial featured conversations of SHAC activists talking shit about animals in an attempt to paint them as only posing as animal lovers.
- >> Don't waste time worrying about phone taps or imagining that strange clicks or other noises indicate a phone tap. Many taps are virtually impossible to detect. Phones are not secure. Assume your phone is tapped when dealing with truly sensitive issues, as most cell phone conversations can be recalled when needed, even if the phone itself is not tapped.
- >> Most cell phone companies, not to mention the NSA, keep logs of all cell phone traffic—including what number called what number and when—and text messages—including messages you delete from your phone. Cell phones are not secure; act accordingly.
- >> Consider an alternative to storing all of your phone numbers directly in your cell phone. If your cell phone falls into the wrong hands, will it be okay for your adversaries to have all those numbers so easily accessible, in one place? Also, keep in mind the photos you have on your phone.
- >> Do not give out phone numbers, addresses, or any personal or sensitive information to unknown callers; always verify a caller's legitimacy. Politely and subtly verify the legitimacy of reporters, as well, and consider using a believable alias with the media—especially if you don't want your political actions to be the first thing that come up on an internet search of your name by your family or prospective bosses.
- >> Don't talk in obvious or unnecessary code on the telephone. If you are being tapped and the transcript is used against you in court, the coded conversations can be alleged to mean anything by the government code “experts.”
- >> Don't gossip about sensitive people or projects on the telephone. All information that an outsider can learn about you and your projects is valuable and makes everyone vulnerable.
- >> If you receive threatening calls on your voicemail or answering machine, make sure to save the message. Keep a pad and pen next to the telephone or along with your cell phone and jot down details of threatening or suspicious calls immediately. Note the time and date, keep a file in a safe place, and speak with a movement lawyer.

## **MAIL**

>> Sometimes the feds surveil personal and political correspondence before it leaves the post office. Be aware that the US Postal Service will give out your information if you have a post office box under certain circumstances.

>> If you receive a threatening letter, handle it as little as possible. Put both the letter and the envelope in a plastic bag or file folder. If you must, give only a copy to a sympathetic lawyer who could handle the legal side of things, and if you are being threatened for open organizing it may be advantageous to make this public in the media.

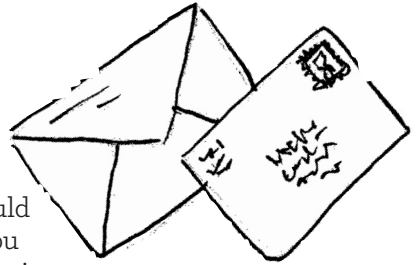

## **AUTOMOBILES**

>> Keep your automobile clean so you can see if there is an addition or loss.

>> Don't put identifying bumper stickers on your car; make your car look ordinary.

>> Put your literature in the trunk or in a closed box, in case you are stopped by the police—even for something routine.

>> Keep your car locked at all times.

>> When traveling, put your backpack, purse, or computer bag out of reach of the windows; put them behind your legs or tuck them up under the dash against the fire wall.

## **UNDER SURVEILLANCE?**

>> Disclose to those you work with about known or suspected surveillance. Be scrupulous with documentation.

>> Do not dismiss complaints about others as paranoia; the opposition frequently has informants join organizations to learn about methods and strategy.

>> Discuss incidents with comrades, family, and co-workers who have experience with State repression and surveillance. Talking about it can make the secret dirty work of the intelligence agencies and private spies easier to spot and less scary to deal with. Don't try to tough it out alone; keeping us isolated is one of the goals of surveillance.

>> If you wish to have a private conversation, leave your home, office or vehicle and take a walk or go somewhere very public and notice who can hear you.

>> Photograph the person(s) following you or have a friend do so. Use caution. If someone is overtly following you or surveilling you, they are likely trying to intimidate or frighten you. If you are covertly being followed, have a friend covertly photograph them.

>> If you are being followed, get the license plate number and state. Try to get a description of the driver and the car, as well as passengers. Notice anything different about the car, and write it all down.

>> If you are pulled over or detained and are able to, lock your texts if you have text secure or delete your text history, call history, and search history in your phone. Or take the battery or SIM card out of the phone and put it somewhere else, so it won't work. This will not hold up under intense scrutiny, but may save you from arrest in the moment, or at least slow investigations so that the police will have to request your information from the phone carrier.

>> Debrief yourself immediately after each incident. Write details down; time, date, occasion, incident, characteristics of the person(s), impressions, anything odd about the situation.

>> Keep a “weirdo” file with detailed notes about unsettling situations and see if a pattern emerges.

## **VISITS FROM THE FBI**

>> Don't talk to the FBI or any government investigator, especially without your attorney present. If they come to your home or office, step outside and close the door behind you. Use the magic words: “I'm going to remain silent. I want to see my lawyer.” At most, ask for their card, then clearly end the interaction by walking away or returning inside.

>> Immediately after an FBI visit or interaction, contact the National Lawyers Guild at 1 (888) NLG ECO LAW or contact your own movement lawyer or legal support group. Do not isolate yourself or try to deal with it all on your own!



>> When appropriate, write for your government files under the Freedom of Information Act (FOIA) and keep writing to the agencies until they give you all the documents filed under your name. Contact a lawyer for help; there are many complicated tricks the state uses to attempt to deny your request or hide information from you.

>> It may be important to have challenging conversations that are important for your safety with your family and loved ones who are not engaged in resistance movements about the correct way to act with law enforcement if they come around asking about you. Even though you would never talk to the FBI, your mom may, just to try to keep you out of trouble. It is important for others in your life to realize that the best way to keep you safe is to refuse to talk to police or let them into their homes, and to always get a card from the agent and tell you about the harassment. If your family members are resistant to this idea, see if a lawyer will talk with them and tell them the same advice.

Check out the ***Know Your Rights*** section for more information.



British police round up activists trashing GMO crops.



# >>> ELECTRONIC SECURITY

Computers, cell phones, and other assorted gadgets offer us a broad range of tools that can strengthen our efforts in defense of the Earth. They allow us to get satellite images of an action location in a matter of seconds, research who invests in the corporations we are fighting, and send photos from a remote treetop to media outlets all over the world. Unfortunately these technologies allow for an unprecedented level of surveillance of our activities that would have been unimaginable just twenty years ago. While nothing is foolproof there are several basic measures that can improve the security of your information while you use these gizmos to tear down the industrial machine.

## COMPUTERS

Everything you do on your computer is potentially stored on it forever. Even if you erase a file, it is possible for tech savvy people to retrieve those files. It is safest to assume that anything you have ever done on a computer could potentially be recovered by a third party. Likewise everything you do on the internet leaves some sort of track leading back to the computer you use, as well as the location from which you connected to the internet. As has been revealed by Edward Snowden's leaking of top secret NSA files, governments and private companies both collect and store massive amounts of information on individuals' use of the internet.



The only truly anonymous way to use the internet is to use a public computer, like at a college or a library, where you are not required to show ID, or to buy a computer in a manner that is not traceable to you that you never use for any personal reasons—including personal email, banking, and social media—and only connect to the internet from public connections such as coffee shops or libraries. Even then you must still be mindful of things such as security cameras that might record your presence.

There are, however, a number of ways to protect the information on your computer as well as make it more difficult for our adversaries to track what you do on the internet. None of these measures are 100 percent guaranteed to be impossible for law enforcement to break, but they can increase your security. Also it is important to remember that while the NSA and FBI may have more capacity for cracking codes and hacking

into computers, they are not the only ones we have to worry about. Local law enforcement and private security firms are also active in gathering electronic data and may not be as well equipped to circumvent basic security measures.

## **FIRST LINES OF DEFENSE**

While much of computer security is focused on internet related uses, you need to make sure your computer itself is secure. None of the other security measures will work if outside parties can access your computer and install spyware on it. The first line of defense is password protecting your computer. All operating systems have this option, and while law enforcement sometimes has ways around these passwords—especially Windows which sucks all around for security, it is still worth doing. Crappy passwords are easy to crack. At minimum your password should be at least 8 characters and contain a combination of upper case and lowercase letters, numbers, and symbols. This goes for all passwords you use such as your email account.

There is also software such as Predator, which allows you to turn a USB flash drive into a “key” to access your computer. Basically you cannot access the computer unless that flash drive is plugged into it. Some computers now come with a fingerprint scanner, which locks the computer until you scan your fingerprint over it. Kinda creepy huh?

Now that you have made steps to make it difficult, if not impossible, for someone to just turn on your computer and start using it without your knowledge, the next thing to do is install anti-virus software on your computer and make sure you keep it up to date. Avast and AVG are two popular free antivirus programs. It is extremely easy for even amateur hackers to hack into a computer that does not have anti-virus software. You must make sure you keep it up to date because these companies are constantly updating the software to combat new viruses and vulnerabilities as they arise.

## **ENCRYPTION**

Even if your operating system is password protected, someone could still get the files off of your hard drive. To add a layer of protection, encrypt your entire hard drive or create an encrypted folder where you store sensitive files. Encryption uses complex algorithms that turn your information into an unreadable ciphertext which can only be decoded by someone that has the electronic key to it. Two free services for this are Truecrypt and Diskcryptor.

It is also possible to encrypt your email messages. Some email providers such as Riseup.net automatically encrypt messages between fellow

users. That is, if you send an email from `directactionmanual@riseup.net` to `fuckthefbi@riseup.net` it would automatically be encrypted. But if that same email went from `directactionmanual@riseup.net` to `fuckthefbi@gmail.com`, the encryption wouldn't work. You can also install programs that will encrypt emails from most email providers. PGP is the most popular encryption tool. The person you are sending an email to must have the program installed too in order for the encryption to work.

Most computer geeks, including Edward Snowden himself, believe encryption to be nearly uncrackable, at the moment. That being said, it has been confirmed that the NSA actually singles out all encrypted messages that they manage to intercept and stores them in a special file in hopes of later decrypting them. Oh, and by the way, the NSA is reportedly working on building a high powered computer that would be able to break even the best encryption. Whether or not the NSA gives a damn about the activities of radical environmentalists and the degree to which they share information with other law enforcement is anyone's guess.

## **ANONYMOUS WEB SURFING**

There are a couple of ways to better cover your tracks when surfing the internet. The simplest is to use a proxy server. These are websites that you can log into, and through them you connect to the website you actually want to use. The proxy server hides your IP address from the website you are connecting to, so in theory, your connection is completely anonymous. Proxy servers do not automatically anonymize the information that applications such as Flash Player communicate from your computer to a website, which could lead to your web identity being revealed to third parties unless additional steps are taken. There are numerous free proxy servers available on the web. Make sure to use one that is trusted; some are scams and/or do a poor job of protecting your information. Even the good ones can be slow and some websites won't even work through them. At the time this went to print Anonymouse, Hide My Ass, and Proxify were all considered to be reputable web proxies.

Virtual Private Networks or VPNs are another way to increase your online security. Most of the reputable VPN's out there are paid-for services, but it may very well be worth it. Unlike a proxy, a VPN service provider encrypts all of your traffic, replacing your Internet Service Provider and routing ALL traffic through the VPN server, including all programs and applications. It also hides your IP address from third parties.

Another service available to better hide your internet activity is TOR. TOR works by sending online communications on a randomized wild goose chase around the globe in order to obfuscate where they are coming from. TOR is considered to be a fairly secure way to cover your

tracks on the internet, though it is possible with concerted effort, for law enforcement to track someone through Tor. Here's what the NSA has to say about Tor in a leaked presentation titled Tor Stinks, "We will never be able to unmask all Tor users all of the time," but "with manual analysis we can de-anonymize a very small fraction of Tor users." This internal document confirms that there is no systematic way for them to undo what Tor is doing, but described several ways in which user slip-ups and weaknesses in systems they might be using can allow the NSA to figure out things about Tor users in spite of what Tor is trying to do.

Finally, the folks that brought us Tor have created a program called TAILS, or The Amnesic Incognito Live System, which is designed to help further cover up tracks that snoopers like the NSA might be able to recover. Check it out on the Tor website.

Whatever service you use, an important thing to look into is whether they store data logs of your internet activity or automatically delete it. If they hold on to your data, this information can be subpoenaed, in which case all your "anonymous" web use will be for nothing. Only use services that do not hold onto data. It is very important that you fully educate yourself on how these services work before you put your trust in them. There are numerous other security measures you must take to ensure that these services properly hide your identity.

### **REMOTELY TURNING ON MICROPHONES AND CAMERAS**

As with cell phones, it is possible for a third party to hack into your computer and remotely turn on the microphone as well as the video camera if your computer is equipped with them. Basically, your own computer can be turned into a surveillance device by law enforcement. Blocking the video is as simple as putting a piece of tape over the lens when you are not using it. As far as audio goes, desktops, which don't have batteries, can simply be unplugged if this is a concern. And laptops should simply be moved away from where sensitive conversations may take place. Or just take your computer apart and clip the wires to the microphone if you want to settle it once and for all.

### **CELL PHONES, YOUR OWN PERSONAL WIRETAP & TRACKING DEVICE**

We are all familiar with the notion that the police tap people's phones in order to listen to their phone conversations. Unfortunately when it comes to cell phones, wiretaps are just the tip of the iceberg. Cell phones, especially smartphones, are basically miniature computers. Anything you do on them is likely to be retrievable by a third party. This includes information on who you have called and who has called you, text messages, and voicemails. This information is still potentially retrievable

even if you delete it from your phone. Police have on several occasions used recovered text messages to prosecute activists in court. Even if you are able to permanently delete this information from your phone, it is highly probable that your phone network provider holds on to it.

Even if you never do anything illegal on your phone, you are exposing yourself to a frightening level of surveillance anytime you have your phone with you.

Anytime a cell phone is in an area with reception, whether or not it has GPS, your exact location is being pinpointed by the cell towers in the area through triangulation. Phone companies hold this information and readily provide it to law enforcement, often without even being presented with a warrant. If you are under active surveillance, law enforcement can use this information to track your movements in real time. **Never bring your cellphone with you if you do not want your location and conversations to be recorded.**

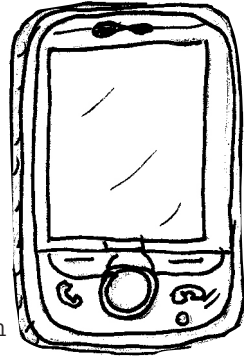

Law enforcement also has the ability to remotely activate the microphone on your cell phone in order to turn it into a listening device. They can do this even if your phone is turned off. If you are ever holding a conversation that you do not want to be listened to, you must either take the battery out of your phone or have the conversation far away from phones.

## GPS

It should go without saying that any gadget that uses GPS technology is recording your location, that's the whole point of the damn things. Don't forget that many newer models of cars have GPSs installed in them. It has been recently revealed that automakers have access to your GPS data and some store it indefinitely. Some rental car companies also put GPSs in their cars so that they can catch renters that are driving way too fast, or perhaps taking the car further afield than the contract allows for.

## TAKE A DEEP BREATH

Now that we've scared the shit out of you with this short examination of the surveillance state we live in, it's time to take a deep breath. All of these security protocols are a bit overwhelming. It's up to you how much you want to fly under the radar. Your level of security really depends on what activities you are engaged in and the level of repression you are likely to endure if the police get ahold of your sensitive info. Many activists feel completely comfortable using their personal computers and phones for doing research, organizing meetings, and holding conference calls when organizing public direct action campaigns. Many others choose to keep

sensitive information about protest plans, such as the time and location, off of electronic devices—only discussing such matters face to face.

Activist groups would do well to encrypt information that is stored on their computers and use secure means to communicate with each other in all aspects of public campaigns, but the fact of the matter is that this is not always possible. We can't allow ourselves to be paralyzed by fear. Protect your electronic information related to public campaigns, but in the context of above ground organizing in the US, it is usually not detrimental if these advanced security measures are not observed.

Given the numerous points at which law enforcement can potentially circumvent security measures, any activities that could lead to serious jail time—we're talking felonies—should never be done from a computer, phone, or internet connection that could be traced back to you. There are simply no guarantees that the police won't be able to find a way around your security measures. Fortunately it is easy enough to get a burner phone (prepaid cell phone not connected to a name) and a used laptop anonymously and to connect using prepaid phone cards and public wireless connections.

Technology is constantly changing. This article, written in 2014, will likely be out of date in a year or two. It is important that you educate yourself on electronic security, knowing what the current surveillance capabilities of the government are, as well as the ways to circumvent them. If all else fails see the ***Tin Foil Hats*** section.

# »»» ECO - LIBERATION

Dealing with the dynamics of privilege and oppression is something that all movements for a more just and sustainable world have to address. We cannot expect to win any of the battles in our fight for a better world if it is constantly plagued with disrespect, internal violence, and oppression. Unfortunately, it is a struggle to get many folks with social privileges to acknowledge this necessity and do the work to dismantle privilege and challenge oppression on structural and personal levels.

What are we talking about anyway? Is this the first time you've heard about or are thinking about words like privilege, oppression, or marginalization? Are you familiar with these concepts, but know it's a lifelong effort to challenge oppression? Either way, please seek out workshops, readings by people with marginalized identities different from your own, and conversations with those you organize with on these topics. This is a mere introduction, but the deep, transformative work is ongoing and happens in your daily life.

***“You cannot seriously address the destruction of wilderness without addressing the society that is destroying it. It’s about time for the ecology movement to stop considering itself as separate from the social justice movement. The same power that manifests itself as resource extraction in the countryside manifests itself as racism, classism, and human exploitation in the city. The ecology movement must recognize that we are just one front in a long, proud, history of resistance.”***

**– JUDI BARI  
1949-1997**

The basic idea is that people are not treated equally because of beliefs that are deeply woven into the social fabric of our lives. Those who are on the top of any or all of the different hierarchies—and there are a lot of them—have privileges in our society that extend politically and socially, in structural and interpersonal ways. Those who aren't on top are oppressed or marginalized, again in both structural and interpersonal ways. The resulting effects of these dynamics play out in a multitude of different ways. Some of these dynamics are straightforward and easy to see—like the way racism/white supremacy values white people and results in everything from the prison system (slavery) to

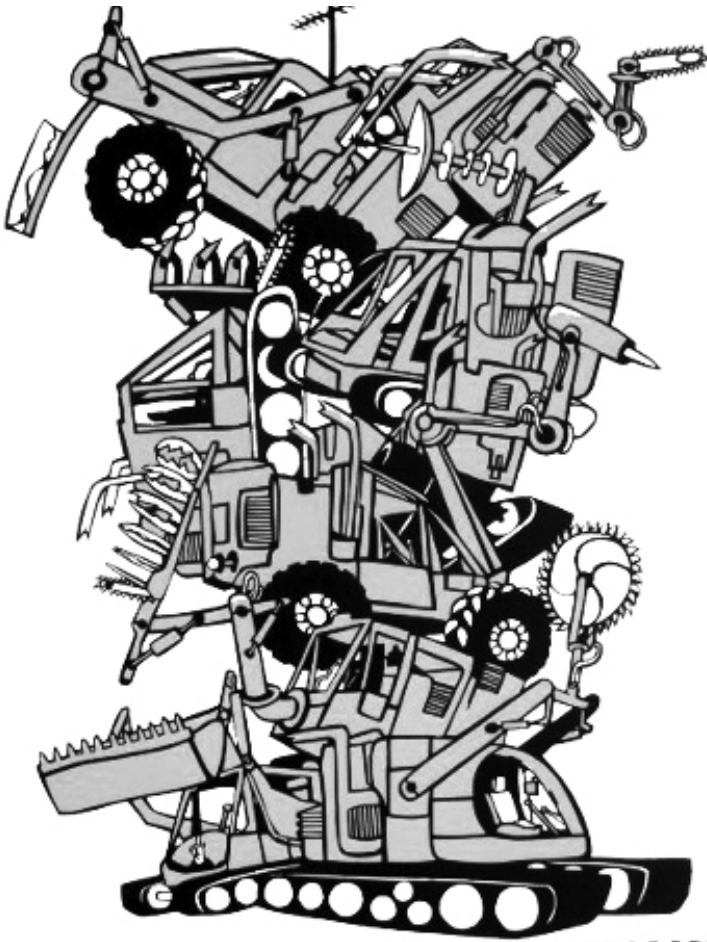

## **DESTROY WHAT DESTROYS YOU**

the acceptance of derogatory language for brown and black people. Or sexism/patriarchy/misogyny that puts men over women, and those who don't conform to their assigned binary gender, and results in things like the prevalence of rape culture. Or classism that creates cultural standards as signified through acceptable language, dress, and behavior excluding working class and poor people from much of public and social life. Or ableism that creates impasses in work, organizing, and social life if you do not have what our culture deems a normal and healthy mind and body.

However, oppression is much more than the societal or overt personal acts of racism (sexism, ableism, etc...). It creeps its way into our social and political relationships, and is incredibly damaging and painful for the person or people being affected—as well as to our strength and sense



of solidarity as a movement and our credibility with others.

The way in which our society values people differently based on their identities is certainly present in, and destructive to, the environmental movement and all resistance movements. We can learn lessons from the conflicts and ruptures in many past social movements, and prioritize an integrative approach to combatting oppression in all its forms. The history of Earth First! is filled with examples of people being driven away, being ignored and disrespected, being assaulted and abused because of subtle or outright racism, classism, sexism, and/or other oppressive behaviors—and recognizing that history alone, does not make it only a part of the past.

It is important to be aware of the ways individuals in our movement have participated—and do participate—in oppression. Racist notions that the borders should be closed to keep “polluting migrants” out of the desert and to stop more people from joining this high consuming lifestyle have long been gone from Earth First! politics, but that did not mean the crew planning the Organizers Conference in Tucson in 2009 paid enough attention to realize that camp participants had to drive through a border checkpoint to get to the camp. Even with a wider variety of people organizing campaigns and attending EF! gatherings, it is still cis-men and male voices, as well as white people, being seen and heard the most. Our social circles are often a safer space than general society, but rape and assault still happen within our movement. Discussions of decolonization have become a regular part of EF!, yet it is still all too frequent that when organizing national or local gatherings, indigenous peoples and histories are ignored.

We must go deeper than surface-level actions and placating changes, to explore our underlying assumptions and prejudices. Think about who is the most visible in this movement. Who gets invited to the secret meetings, and who doesn't even know they exist? How do we move beyond the pervasive thought that fighting against the oppression of people is not included in the fight against the oppression of the Earth? What does it say about our movement when the people who stick around for years are predominantly people with more social privilege? How does it feel knowing that some people aren't comfortable inviting people of color to our events and gatherings because they don't want to subject their friends to a racist environment? When most trainings are being led by men and white people, what is the value being assigned to people with other identities? Even though every gathering now has at least one, and more commonly many, workshops offered about these topics, they are easy to ignore and skip—and it's still all too easy to maintain status in this movement without participating in these discussions or challenging our own behaviors.

While much of what needs to be done to address oppression is obvious, there are also a lot of complexities to consider. This is a long road, and not one that necessarily has a destination. Working to undermine privilege is going to be a process that is filled with mistakes and missteps, and it's going to take time and thought and some painful moments. Along the way it can be helpful to remember that the goal is not to “get it done” and that “being an ally” is not something you can accomplish—allyship is shown through actions, not embodied in a person, no matter how many acts of solidarity they have performed in the past. This work is a lifelong process that we are all in the midst of, and it is important to begin to challenge oppressive actions, to constantly question our own thoughts and assumptions, and to strive to be intentional in the ways we treat each other.

### **JUST TO GET IT STARTED**

>> Recognize that we are all standing on the shoulders of resistance movements that have existed for decades or centuries.

>> Environmental Justice is important to learn about. Communities of color experiencing rampant environmentally racist destruction have a lot to teach us all about resistance and justice.

>> When new folks come to meetings/camp outs/actions/gatherings, be friendly. Especially if they don't dress, look like, and use the same slang as the group. Think about what it feels like to be in a space where you look differently than most of the other people there.

>> Always seeing privileged people holding power, skills, or knowledge could be a turn off to anyone. Build skills across the group and with new members. If an action is going to be planned, include people on various levels. Stop holding power by being the person with the most skills; share power by training others.

>> If yours is a voice that gets readily listened to, take a step back. Don't push your agenda or dominate the group—share meeting facilitation, talk less, help train someone else to do the trainings, and pass on as much of the institutional knowledge as possible. Use that position of privilege to make sure others are heard with equal time and weight given to their words.

>> Be intentional about who the public face of the group is. Are privileged folks always in the forefront, always the media spokesperson, the name on the press release and flier, signing all the emails, and filling any and all high profile roles?

>> If there is a role, like scouting for instance, that accumulates knowledge as it gets done day after day, make sure to have a plan in place to share that knowledge so that skills are being built as an entire group.

>> Create space for the group to discuss oppression. Bury the idea that political correctness is holding people back. It is valid for people to feel disrespected, based on others' actions or words. Oppression is real and ignoring it or dismissing it is not radical.



Zapatistas in a standoff with the Mexican Army, demonstrating that by building power together, we can be powerful in our fight.



# HOW TO DO IT

*Detroit residents block a shipment of petroleum coke, a byproduct of tar sands refining, that is poisoning their community, 2013*

# >>>ANATOMY OF AN ACTION

Direct action, simply put, means solving problems yourself rather than petitioning the authorities or relying on external institutions. Any action that sidesteps regulations and representation to accomplish goals directly is direct action. In a society in which political power, economic capital, and social control are centralized in the hands of an elite, certain forms of direct action are discouraged, to say the least. These forms are of particular interest to those who struggle against hierarchy and oppression.

There are countless scenarios in which you might want to use this kind of direct action. Perhaps despicable multinational corporations are invading your bioregion to begin construction on new energy infrastructure; perhaps they've been there a long time, operating facilities that exploit workers and ravage the environment, and you want to draw attention to or hinder their misdeeds; perhaps you want to organize a festive, community-oriented event such as a street party. Direct action can plant a public garden in an abandoned lot or defend it by paralyzing bulldozers; it can be used to occupy empty buildings to house people without homes or to shut down government offices. Whether you're acting in secret with a trusted friend or in a mass action with thousands of others, the basic elements are the same.

## **BRAINSTORMING**

Choose a project and devise a plan. Begin by brainstorming ideas in a secure environment with a trusted friend or affinity group. Keep your ideas to yourselves as you hash them out so you won't have already given away all the secrets before you're ready to try them. Often, the best brainstorming doesn't happen consciously, but in the course of daydreams and informal conversations—it's a good policy to trust that your craziest ideas can become reality and try them out.

Brainstorming can start with a problem you want to solve or a social contribution you want to make; it can be informed by the resources you have, the kind of experiences you desire, or the people you want to work with. You can plot a single short adventure or a long-term campaign. Start simply, and increase the complexity and ferociousness of your actions as you go. A strategic escalation of tactics can force your enemy's hand and is more likely to help you build the infrastructure you need to complete your epic tasks.

Be clear about who you want to organize the action with and what levels of security you want to establish for communicating about it—based on how much you want the element of surprise. Remember that you can always lessen the amount of security you’re using as you progress in planning your action, but you can’t go the other direction. Figure out if you want to organize the action with a small group of friends, an organization, or a larger group of people. If it makes sense for your action to be organized openly, establish a format, such as a public assembly or spokescouncil, in which to work out a strategy and tactics, but be sure to come with proposals in mind, in case no one else does. Even if you are attending a massive event organized by others, always have a plan so you can contribute to it in your own way.

**GOALS**

Establish and prioritize the goals of the action from the outset. This will forestall future conflicts if your plans shift and you have to make decisions quickly. Be sure to differentiate between your goals, strategies, and tactics. Set long-term, medium-term, and short-term goals (clear

descriptions of what you want), and don’t skip straight to the strategies (plans

for how to achieve your goals) or tactics (the set of actions used to implement your strategy).

Understanding your goals and strategies clearly will make it easier to identify how to shift your tactical decisions as the political and material context changes around you.



Determine your goals by asking, what is the purpose of your action? Is it meant to halt construction or destruction?

Is it meant to communicate ideas, to call attention to an injustice, or to inspire people? Is it meant to put the pressure on a particular corporation, to inflict crippling material damages, or to set a particular tone? Is it meant to secure resources, to demonstrate a model others can apply, or to be a learning and bonding experience for those involved?

And who needs to know about your action? Is it directed at on-the-spot spectators, corporate media viewers,



the owners of specific corporations, their stockholders, the police and government, other members of the radical community, the participants themselves?

## **AFFINITY GROUPS**

Work tightly with those you know. One of the most efficient and secure models for direct action organizing is the affinity group model. An affinity group is a group of friends who trust each other deeply and share the same goals. Working together over a long period of time, an affinity group can become more efficient and effective because they learn how to communicate with one another, how they each handle crises, and how they can support each other.

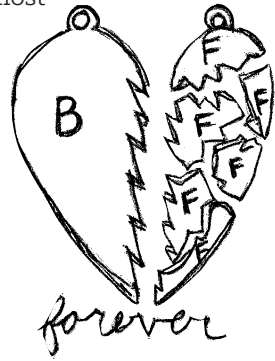

For a small action, the members of an affinity group can take on different roles. For a larger action, affinity groups can work together in a cluster of multiple affinity groups, each one playing a specific role. This can make decision-making easier than it would be in one big mass, as each group can send a representative to discussions. Clusters of affinity groups can also work together over long periods, building trust and effectiveness.

## **RECRUITING**

Bring in other individuals and groups carefully. Once you have a plan to propose, figure out how many people you need to accomplish it. Invite only people you trust to keep secrets and that you are sure will want to join in—everyone you invite who doesn't end up participating is a needless security risk. Extend invitations one by one, or affinity group by affinity group, so those who decide against participating will not know anything about the others involved; likewise, ask general questions at first, and don't reveal critical details of the plan such as exact target or date until a person is ready to make a commitment. As people are brought into a plan and go on to bring in others, make sure everyone has the same idea of how cautiously this should be done.

As more people become involved in the project, it's important that everyone understands how much commitment is expected of them. Sometimes the group that first presents a plan will be more invested in it than others; if they do months of work preparing, only to have another group they depended on drop out at the last minute, all that work is



wasted. Everyone shares the responsibility of being honest from the beginning about what others can expect from them. At the same time, those who initiate a project should be careful to share ownership of it with everyone else involved.

## **DYNAMICS**

Make sure power is distributed evenly within your group. Rotate roles regularly and make all decisions in a participatory and consensual manner. If your group is large enough to warrant it, use a formal consensus meeting process to make sure all voices are heard: set an agenda for each meeting, and pick a facilitator to keep meetings on track and keep track of whose turn it is to speak. The better structured your process is, the more likely it is that everyone will get to participate equally.

Be aware of internal dynamics that may be unbalanced, such as those between people with different privilege because of identity or socialization, or between local organizers and participants from out of town. The more equally everyone participates in planning and preparing for the action, the more invested in its success everyone will be and the smarter the group as a whole will be. Make sure to check in with each other both inside and outside of formal structures to ensure that everyone feels supported and comfortable throughout the project. Though often overlooked, maintaining morale is a critical aspect of fast-paced group problem solving and keeping level heads in the face of surprises and uncertainty.

## **LEGAL SUPPORT INFRASTRUCTURE**

Everyone involved in the action should be aware of and prepared for the risks they are taking and the potential criminal charges associated with those risks. It's important not to take things farther than you feel ready to go: if you get hurt or arrested or otherwise in trouble while engaging in a level of risk for which you are not emotionally prepared, the effects can be debilitating. Far better that you get started slowly, building a sustainable involvement with direct action projects that can continue over a lifetime, than rush into an action, have a bad experience, and swear off all such activity.

Whether you're planning an action with zero or several intended arrests, think through all the possible arrest scenarios that could happen connected to your action, and prepare a legal support structure to accommodate the unexpected. This could include a legal aid number for arrestees to call, legal observers to monitor and document the actions of police, money for bail, lawyers to provide immediate support to arrestees and to represent them in court, and a circle of people prepared

to offer emotional, financial, and logistical support throughout court cases. Remember that the legal aid number should not incriminate the arrestees or the people who receive the calls—if part of your alibi is that you don't know each other, don't all call the same number from jail. If you fear you will forget the number, write it on your body in permanent marker.

Check out **Action Legal** and **Know Your Rights** for more details.

## **MEDIA**

Establish what coverage you want and get it. Long before an action, when you are establishing and prioritizing goals, work out exactly how much media coverage you want, from which sources, and how you are going to obtain or avoid it. This could mean composing and sending out a press release (Who, What, When, Where, How, Why) or a communiqué, electing a spokesperson to represent your project to the press, inviting corporate or independent reporters to the action or to a press conference, faxing announcements or making press calls, offering interviews (in person or anonymously over the phone), or having members of your group cover documentation themselves. If you want to avoid certain kinds of coverage, it could also mean assigning a participant to make sure photographers do not aim their cameras at those involved.

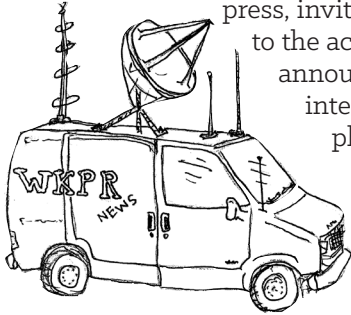

Check out **Action Media** for more details.

## **RECONNAISSANCE**

Before the action, study the site of the action carefully and keep up with any changes. Be sure to do at least some of your scouting at the same time of day as the planned action, and if possible do a quick check immediately before it to make sure nothing has changed. If your action calls for daunting tasks, such as climbing a steep rooftop, it may be good to make an actual practice run at some point.

Check out **Scouting** for more details.

## **PLANNING**

Study the context, chart a strategy, and plan for different scenarios. Proper planning is the essence of safe, effective direct action. Keeping your goals and priorities in mind along with the resources you have to work with, plot and compare different strategies. Weigh out the risks and potential rewards of each: always pick the safest way to accomplish

a given objective, and make sure you can afford to take the risks you choose. It often happens that as the planning process goes on, a project will get more and more ambitious and hazardous, until some of those involved start to have doubts; at this point, it may be necessary to work out a safer or scaled-down version of the plan, so it can still take place.

There are countless factors to take into account in planning. You must pick the most effective tactics in the context of the current social and political situation. You must pick the best location for the action and take into account all its attributes; likewise, you must pick the best date and time of day. You must bear in mind the others who will be in the area, and how they can be expected to react—will they be sympathetic, or will hostile vigilantes interfere with your activities? You must coordinate the timing of different parts of the action, predicting how long each will take, and figure out how those involved in the action will communicate.

When predicting the responses of others—say, for example, the police—consider the factors influencing them: Are they expecting what you're planning, or do you have the element of surprise? If you have the advantage of surprise, how long will it last? Will there be a lot of attention focused on the event? Will it be immediately apparent what you are doing? Will there be middle class citizens or reporters around, and will their presence put a damper on the authorities' response? What is their strategy likely to be? Do their bosses want them to come down hard on you, or to avoid provoking a scene? How well do they communicate, how fast do they move, where are they located and what routes will they take?

Plan several options both for how you will enter and set up your action and for when and how you will exit. Because plans rarely come off exactly as they are laid, it's important to have backup plans worked out for different scenarios: "If \_\_\_\_, we'll \_\_\_\_; if \_\_\_\_, we'll \_\_\_\_." Have a few different objectives in mind, in case your ideal one turns out to be impossible. Don't underestimate the challenges of simple logistical matters, such as transporting people or communicating in stressful situations. Having a basic structure for communications and decision-making in place will help you be prepared for situations that play out differently than any of the scenarios you had imagined.

In some cases, you can bring together multi-leveled groups in which people are taking different risks and everyone knows the general goal but only a few know critical details such as what the target is—until the last minute—or who is carrying out the most risky activity. However, be careful not to put some people at risk for others' actions; the authorities

will probably charge whomever they get their hands on with the worst crimes they can, so it's important both to get those who take risks out of the area safely and to make sure serious charges can't stick to anyone else.

Be prepared for the best case scenario as well as the worst. New ideas, if they are good ones, tend to fail because people don't take them far enough, whereas older ideas usually fail because they are too familiar to everyone, including the authorities. Sometimes the best results come from applying familiar tactics in entirely new settings.

Look back in time for precedents, occasions when similar actions were attempted in similar contexts; these can be very instructive. As you gather years of experience and learn from the successes and failures of others, you'll develop skills for predicting and preparing for a wide variety of situations.

### **PREPARATION**

Once your plans are made, draw up a timeline until your action, counting backwards from the big day to establish the deadlines for all the pieces that must be in place. Early on in the planning, work out what funding, materials, and other resources you will need and how to obtain them. Make sure that you have all the equipment that you need, and that you have done enough test runs to be certain of assembly and use. If security is a priority, obtain what you need in such a way that it cannot be traced to you—thinking about paper trails like credit card records, security camera footage, and cell phone tracking—or have friends from out of town acquire potentially incriminating materials far from the site of the action so they don't arouse suspicion.



Make sure everyone has appropriate clothes for the action, including different outfits in layers if necessary. Consider what you will need to deal with the weather if you'll be outside for a long time. Coordinate your outfits and costumes. Is it an action where everyone will wear t-shirts with anti-fracking messages or white hazmat suits to be a theatrical, yet unidentifiable crowd. If everyone is dressing in black for anonymity, be sure no one's clothes have identifying features; likewise, if you're going to be posing as random passers-by, remember that people dress differently in Miami than in Seattle. If timing is important, make sure everyone's watches are synchronized.

Double-check to make sure everything is ready by your deadline; go through a practice run, verbally if not physically. If participants are unfamiliar with the area, distribute maps. If need be, plant necessary materials in the area in advance of the action, but be careful not to give anything away by doing so.

## **ROLES**

Divide up responsibilities and set up decision-making structures. Establish all the roles necessary to pull off your plan and make sure every one of these is filled. Roles might include lookouts, scouts, police liaisons, media spokespeople, internal media, legal aid contacts, legal observers, medics, distractions, “plants” (for example, people disguised as innocent bystanders who are ready to intervene if necessary, or who will politely honk their horns while a barricade is erected in front of them), getaway drivers, people to transport materials, people to receive information and make tactical decisions, and people to carry out the actual action.

In some situations, it is wise to have understudies for important roles, in case it turns out at the last minute that someone can't participate. This is especially true if you don't know in advance what the date of your action will be—for example, if it is to coincide with the beginning of the clearing for construction.

## **DIPLOMACY**

Consider the way the action will affect others. If your action is taking place during or as part of a larger event, there may be spokescouncil or coalition meetings at which different groups try to coordinate their efforts; these can be useful, but they tend to consume a lot of time and energy, so make sure you go into them knowing exactly what you hope to accomplish.

Whether you're acting in the midst of thousands of other activists or far away from anyone, take into account the way your actions will affect other people. Will your actions endanger others? Will they provoke police repression? If so, will others bear the brunt of it, and is it possible to offset this? Will your actions make it more difficult for other people to do work in a particular place? Are there negotiations or agreements that should be made to others before, during, or after the action?

During the organizing leading up to the anti-Republican National Convention protests in 2008, groups working on different parts of the demonstration crafted a set of agreements that proved to be incredibly useful in the face of the serious state repression that followed. They

were based on a respect for a diversity of tactics and a separation of time and space for different kinds of tactics, along with a promise to keep criticisms out of the media and a refusal to cooperate with the police. If every organizing body could devise such clear assurances, we'd be much safer and much fiercer!

## **AWARENESS**

Stay alert throughout the action. Awareness is key to the success of any action, because often the atmosphere and the conditions that determine it can change very quickly. Consider having mobile or stationary scouts whose sole purpose is to evaluate the situation in a given area, assess what they see, and convey it to the rest of the folks in the action.

For each individual, it is important to keep up with what is going on around you and to have established in advance how you will react to a given scenario. For example, is the arrival of one police car a big deal? How about ten? Is it common for police to tail demonstrators in this city? While you can never be certain of exactly what will happen, going over possible scenarios in advance and having an idea of how your group wants to deal with them will give everyone a more solid idea of how to react—and how not to overreact—as the situation develops.

When informing others of a development, announce the raw information, not the conclusions you may have drawn from it —“The police are putting on gas masks,” not “They’re going to gas us!”—so others can draw their own conclusions. Resist the urge to panic, and the tendency to get carried away.

## **COMMUNICATIONS**

Keep each other informed. During the action, scouts can keep track of changes in the terrain such as arriving workers or police, crowd movements, others’ activities nearby, and safe zones. They can use communication systems such as cell phones, text messaging, two-way radios, or whistles to keep in touch; audio or visual signals such as car horns or fireworks can also be useful. A police scanner can be used to monitor police communications.

To make communication more efficient, scouts can report to an individual or sub-group in the center of the action; in a larger setting, they can phone in their findings to a central information hub, which others can call with questions.

Just as communications equipment can make you more efficient and effective, it also increases the risk of surveillance. You can use codes and

code names, but be judicious—complicated codes are easy to forget, and prosecutors can argue that your codes meant something more drastic than they actually did. Even if no other communication system is used, it can be useful to have the option of an abort signal for emergencies.

## **DISPERSAL**

Quit while you're ahead. A safe escape is the most commonly overlooked part of direct action organizing. Be sure to have an exit strategy worked out in advance—with at least one contingency plan. If you'll be in a large group, especially with others who haven't been part of the planning process, think about how to avoid the herd mentality that keeps crowds together after it would be better to split up. Know when to press your advantage, and when to quit—when to run as fast as you can, and when to walk nonchalantly. Discard anything that could incriminate you, if possible in a place it will not be found; wait to change your clothes until you're sure you're no longer under observation.

If need be, gather in a safe place afterwards and make sure everyone is accounted for; collect bail money, seek outside assistance, and write press releases. While everyone involved is still around, get contact information for anyone who might be able to testify or provide documentation to assist arrestees.

## **DEBRIEFING**

Make sure to get people together after the action to discuss what went well and what lessons can be learned. Having the time to talk together after a high-stress situation can be crucial for personal emotional health and group morale. Decide the place you want to meet ahead of time, if people may not be able to communicate about it while dispersing from the action site. After the action, destroy any evidence that could be used against you, and keep tools that could be tied to the action in a hiding place outside your home.

Gather people together in an appropriately secure setting and go over what happened and how people feel about it. Follow up with ongoing matters, such as supporting those with court cases, continuing media work to further provide clarification to the public about the goals and ideas behind the action, and sorting out conflicts. Celebrate your victories, offer each other constructive criticism, learn from your mistakes, and lay plans for the next project.



# >>> RESEARCH

## **KNOW YOUR ENEMY: HOW TO RESEARCH AN ACTION TARGET**

Few campaigns are won with a simple protest in front of the corporate headquarters. Successful campaigns usually entail hitting your adversary from multiple angles, so that they feel the heat wherever they go. To achieve this you need to get to know your enemy. Who sits on the board of directors, who are the major investors, who are the major donors for a senator, where does the CEO go to church, where does the mayor eat lunch, when is the next conference sponsored by your target that you can disrupt? A little research can go a long way in strengthening the effectiveness of your campaign.

## **READ THE LOCAL AND NATIONAL NEWS**

While radicals have a justified tendency to snub corporate media, reading the local paper is an easy and effective way to keep an eye out for environmentally destructive projects in your neighborhood. Corporate media will rarely do a good job of reporting on the issue, however they often are the first ones to catch wind of controversial projects. The business section can be especially useful for gleaning information about your corporate adversaries, too. Industry publications, while quite dry, can also be exceedingly useful because there is more straight talk in these publications than in mainstream media. You can learn a lot about long term industry trends, investors, new projects that are being developed, and best of all, what roadblocks the industry is running into. Sometimes you can find an insider's analysis of how your own protest efforts are effecting the industry's bottom line. While informative, these publications can be prohibitively expensive—hundreds of dollars a year. Find out if your local university carries some of them, especially if they have programs in that particular industry.

## **COMPANY WEBSITES**

Most company websites have a directory at the top or bottom of the page with links to addresses of offices, listings of their subsidiary companies, or “corporate governance” pages with names and even pictures of decision makers. You can use these as ruthlessly as you want by either reposting their pictures online describing the horrific projects their company is involved in or focusing on the offices or executives as a point of protest. Your options are endless. Use this basic info to start a national call in day to their offices, mass faxes, office disruptions, or home demonstrations—see ***Making Life Hell***. Keep a look out for their quarterly reports which are available on the website and are packed

with information and dates for their annual shareholders meetings. A common tactic is to buy a small amount of shares in advance to get into the meeting and then disrupt it for as long as possible.

If you cannot find the information you are looking for on the company's website, try Manta.com or Hoovers.com for office locations, executive names, and names of subsidiary businesses. Croctail.corpwatch.org has a searchable database listing subsidiary companies, SEC filings, and a map of locations. LexisNexis is another incredible research tool. Among other resources, it has a site called CorporateAffiliations.com that keeps track of company networks and governance. This is a paid service that most colleges subscribe to, so ask a college student friend to give you their password to access these databases, usually through their library website, or sign up for free trials.

### **CAMPAIGN CONTRIBUTIONS**

There are an array of sites that keep track of who donates to a particular politician's campaign—which is public information. It also keeps track of the address they make the donation from, and many times this is their home. You simply search for the person's name, or search for a company if you don't have a name. Use multiple variations of the company name, as well as acronyms, and you can narrow your search down by state as well. Often, the information is stored as a .pdf that you have to open. Make sure to check the date because if it's a few years old the address may have changed. If this is the case, cross-check the information with other sources like Zabasearch, Intelius (a paid service that will give you information on confirmed current addresses), Whitepages online, and maybe a phone call asking for the person.

### **PROPERTY TAX OFFICE**

If a person owns property in a particular county, their name and more importantly their address, will be listed at the county tax office. First you need to figure out in which county the person lives. The county where the person holds office or where their company is located is a good start. There is a reasonable chance that there will be more than one person under the name you are looking for. Try to get the person's middle name and/or their spouse's name (spouses are often listed on the tax records) in order to narrow down the pool of candidates. Armed with this information you can go to the county tax office and look through their physical records in order to find the person's address. Make sure to have a believable story of why you are looking up the info on this person's property in case you are asked. Most counties now have an online database where you can search the tax records. Try searching the county and state name plus "tax office or records" and you will likely find the site. Once you find the site, type in the name of the person you are

looking for. If they own property in that county you will get an address for it. You might also find out if they are delinquent on their taxes. With online research you won't have to prepare an excuse for the person at the desk, but keep in mind good computer security—see **Electronic Security**.

### **LOCATION RESEARCH**

Before physically scouting a site for a demonstration, it might be helpful to look online to see what the terrain is like. Google Maps can be useful—especially the satellite view which gives you overhead images. For many cities you can use the street view function which will give you a 360° view of the location from the ground, but it may not be available for small towns and rural areas. Bing.com's map function can be useful as well. Instead of satellites their images are taken from airplanes which gives you an overhead view from a 45 degree angle and in many cases allows for more on the ground detail. Once you are on the Bing Map website, click on Birdseye View to use this function. Manta.com is also a great site for looking up businesses that can give you lists of company sites all over the country that may not be listed on their websites, complete with aerial maps.



### **BOARD OF DIRECTORS**

Sites like Investing.businessweek.com will list who is on a company's board of directors and what other companies they are financially affiliated with. Having protests outside the homes and offices of people on these boards can put huge amounts of pressure on a company that you're targeting. Sometimes these people are also professors at colleges who could use a surprise visit during class. Once you find out what town

they live in, try looking them up with a basic internet search. They may mention online what groups they belong to or church they go to.

## **INVESTORS**

Search for a company using Hoovers.com or Nasdaq.com to find the “institutional holders” such as banks and other corporate investors. These are great companies to target because, as tertiary targets, they are easier to influence. For example, if you’re fighting the Enbridge pipeline, the primary target would be the construction itself. The secondary target is the Enbridge company offices. The tertiary targets for them include their largest investors, such as Alpine Advisors Inc., Oppenheimer Funds Inc, Kayne Anderson Capital Advisors, JP MorganChase, or Bank of America. These investors could have offices in every major city across North America leaving a huge opportunity for harming them financially through divestment campaigns while outing them publicly for their dirty affiliations. Some of these targets will cave easily after a few office protests. Because their financial success is not based on this single investment, it’s easy to make them have more to lose by dealing with protestors than dropping the investment. Look to the Stop Huntingdon Animal Cruelty (SHAC) campaign as a model for this. They did not just stop at investors, but also targeted a company’s insurance company, auditor, and the company that delivered lunches to their offices. There are many fronts to fight from. What hurts them the most tends to be their pocketbook.

## **PERMITS**

State, city, county, and town records usually have searchable databases of permits and planning applications. If you’re targeting a proposed construction project, find someone to search for these permits, and you may get information about where they are beginning construction. A lot of grassroots environmental groups do this already, so if you’ve made friends with some of them, see if they will share the information with you without asking what you need it for. Other places you may request public information from are the Department of Transportation and the Department of Natural Resources for your state—see ***A Paperwrencher’s Toolbox***.

## **INDUSTRY CONFERENCES**

While it may be hard to suppress the urge to throw a few stink bombs and run, going undercover at industry conferences can provide a wealth of information on your targets. Like industry publications, there is often more clear information at these events because they are geared towards insiders, not the general public. Put on your best suit and try waltzing right in with confidence and perhaps a fake pass—see ***Pranks***. Unless there is already a strong protest presence, the registration desk will

probably not be taking a close look at passes. If sneaking in doesn't seem possible, it may be worth shelling out the money to actually register for the conference.

### **DUMPSTER DIVE**

Not all companies dispose of their trash in a secure manner. Even those that do will have careless or lazy employees that forget to shred confidential internal documents. So do a little late night dumpster diving and see what you can dig out of the trash.

### **PHONE CALLS, ACTING, AND INFILTRATION**

During the UK anti-road campaigns in the 90's, activists were known to call the local cherry picker company asking when it was available for renting and were able to determine which day of the week it was already booked for use so that it wouldn't be available to extract tree-sitters. Some even managed to get jobs with the road building companies to find out where construction was going next. Phone calls can also be useful in verifying home addresses for a mock flower delivery, or pretending to be a student, journalist, or researcher asking for company details. Come up with a convincing story, prepare your list of questions, and put on your best persona.

### **SOLIDARITY**

People all over the world are fighting against ecologically destructive projects where they live. With a little bit of research, you can extend some direct solidarity to these struggles by finding companies or politicians where you live who are connected to these projects on the other side of the country or the world. Many corporations have worldwide offices and subsidiaries, and the financial institutions that back them are national or international as well. Research ongoing campaigns you have affinity with, find a meaningful target and be thoughtful about how the timing will support the efforts of those on the ground. Look for calls for days of solidarity actions or organize a group where you live. With the right target, one affinity group can have a big effect, even if you're thousands of miles away from where the shits going down.

### **COVER YOUR TRACKS**

While gathering this information is completely legal, what you choose to do with it may not be. Activists with SHAC were sent to prison under the Animal Enterprise Terrorism Act for simply posting the home addresses of corporate executives online. Review some of the history, and check out the **Know Your Rights** and **Computer Security** sections of this book before doing any research from a computer.

# >>> SCOUTING

Scouting or reconnaissance is the art of surveying an area for its action potential. The information you gather while scouting a target area and the daily goings on there will provide the foundation for developing a strategic action plan for that site. Pay attention to details while scouting, and make sure to bring tools for documentation to ensure you can relay those details accurately. Successfully scouting a site requires research, patience, and practice. Whether you are scoping out a corporate office building for an office occupation or monitoring a timber sale, it is crucial to know the lay of the land well in advance of the day of the action.

While scouting, be careful not to call attention to yourself or leave an obvious record of your passing. Consider if passersby might take notice of your circling patterns, what security cameras could capture, cell phone or gps tracking, and credit card records at gas stations and restaurants. It is important to blend into your surroundings so you don't attract suspicion of what you are really up to. Disguise yourself and act natural. Your ability to blend into an area may help determine whether you scout solo, in a pair, or with a group—and may make or break your ability to go forward with your action. Act with forethought and intention. Be careful and don't get caught.

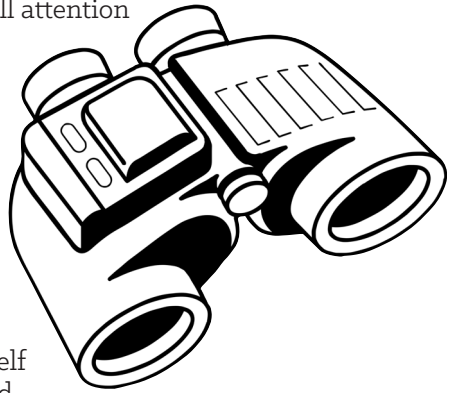

## **SITE SELECTION**

Ask yourself lots of questions when selecting a site for an action. Consider the appropriateness of the site. What is the political significance of the place? How will an action there further your goals and contribute to the narrative you are building in your campaign? Is the site a place where you can intervene at the point of decision or the point of destruction? What is the best case scenario you hope to achieve with an action at the site? What repercussions will an action at the site cause? Who will be affected by an action at the site and are they the appropriate target? Consider the potential for an action there. Do you want to shut down operations at the site for the day—or longer—with a blockade? Do you want to do a banner hang there and cause a ruckus for a few hours? How many people will be needed? Is the site highly visible to others? How accessible is the place for setting up the action and for the media?

Is there a safe place for your group to park or will you need to utilize drivers to drop folks off?

## **PREPARATION**

Meet with your affinity group and discuss the long term and immediate goals of your campaign, the motivations for the action you're scouting, and possible targets. Research those targets, the security at those sites, and precedents for similar actions in the past. Together, select a target and define the goals of the scout. Then make a list of the information that is needed to bring back to your affinity or organizing group.

Get maps of the area to plan your scout. You can find local maps at nearby gas stations and libraries. Some universities have special library collections full of all kinds of—especially in-state—maps. Aerial maps may be available on the internet—see **Research**—and you can get building design maps from the county planning department. In some cases you can obtain information from a tourist center, or call and ask questions on a pretext—like as a student doing a report—or even receive a guided tour. Decide ahead of time if someone will try to go into the office, simply to ask for directions or for some other convincing reason.

Always develop a plan, a contingency plan, and a believable alibi. For instance, could you be a nature photographer or a visual arts student with a sketchpad? Sometimes, even simply scouting can go awry, and you'll have to think on your feet. Never underestimate the power of the unassuming, heteronormative couple on a date.

## **GETTING THERE**

If you're scouting in a car, try to use a vehicle that will blend in. In some places, that may mean a nondescript sedan without stickers, and with legal tags and plates. In other places, maybe that means a small pick-up truck. To keep a higher level of security when scouting, consider other forms of transportation that aren't legally connected to people in your organizing group, like public transportation, biking, or walking. If you're scouting in a car, try to find quiet places with a good line of sight to your target, or make multiple passes of the area with someone—who isn't driving—taking pictures of the site or drawing out a map. Walking or jogging by—perhaps pretending to be on a cell phone while using it to take pictures or video—can often give you a better sense of the terrain than being in a vehicle can.

## **TIMING**

Choosing when to scout is important. Scout the site weeks or even months in advance of the action, so that you can go back on multiple scouting trips if necessary. Make sure to scout the area at the same time



of day and day of the week as the planned action. Be aware of how work holidays could change the character of the site. A 24-hour surveillance of the site will provide a more complete picture of what the site looks and functions like, and may help you choose the best time to start the action. Monitor shift changes, security patrols, delivery traffic, or other consistent patterns you could take advantage of—like when the gates are open or closed. If scouting far in advance, try to check the site again close to the day of the action to make sure nothing has changed.

### **WHAT TO LOOK FOR**

Think of where things will need to be and how they will move into position on the day of the action. Where will you stage the action? How will you transport the people and materials needed for the action? If media is important, what will the action look like from the most accessible vantage point? While scouting the site, have paper maps that you can draw or write notes on or create your own maps. Take pictures or video of the site, but consider the implications for your own security.

Get a general understanding of the site layout, including entrances and exits, transportation corridors, security posts, worker posts, and parking lots. Note where there are locked gates, access to the streets, and public spaces like parks or sidewalks. Imagine all the possible sites for your blockade/lock down/theatrical delivery, like narrow points in the road, doors or other points of entry, proximity to machinery, vehicles on site, or other sturdy things to lock/attach to.

If scouting in the backwoods, note useful landmarks for navigation. Make note of ridges, peaks, valleys, slopes, water courses, trails, indicator trees/rocks, snags, stumps, meadows, and soil types or textures. Mark public closure boundaries, timber sale boundaries, and the locations of heavy machinery on your map.

Chart safe routes in and out; look for hiding places, obstacles, other nearby potential targets, and surveillance cameras—including those in ATMs and stoplights. Note how long it takes to travel key distances, and be aware of the visibility from and of key locations. To measure the distance between two points in a less conspicuous way, walk from one point to the other, counting the number of steps it takes, and record the number. Then measure the distance of your pace—if you don't already know it—and do the math.

### **UNDERSTAND THE BIGGER PICTURE**

Survey the general area around the site as well. Know where the nearest police and fire stations are. How long will it take them to arrive? Where will they be coming from? Can their approach be delayed? Know who

else is in the general area. Are there a lot of workers on site? Nearby, are there workers from the same industry, neighbors affected by the thing you're targeting, random people passing by shopping or going to work? Find off site locations to house legal and media teams, like a nearby coffee shop or motel.

Identify any areas to avoid and look for places you could hide materials for the action. If people and/or materials will be dropped off at the site, find safe, inconspicuous places to park vehicles, and plan out how you will get back to them whether you have time to leave or need to leave quickly. Plan multiple escape routes. Think about if you need to find places large crowds could disperse from or places small groups could disappear into—like populated shopping districts or railroad tracks that lead to abandoned warehouses. Make a plan for where to meet up afterwards if you need to disperse.

Map out access roads to the area, one way streets, parks, and anything else that could be helpful to someone entering or leaving the area. If other people who haven't seen the site need to be able to leave swiftly and on their own, equip everyone with an understanding of the area. Once you've collected all the information you can, it can be helpful to consolidate the important parts into a map suited to your needs. Be careful to dispose of all your paperwork securely—see **Security Culture**.

### ESTIMATING HEIGHT

Find a stick that is about 3 feet long. Grab the stick so that the part above your hand is the same length as the distance from your hand to your eye. Hold the stick upright as you walk backward from the tree. When the top of the tree is inline with the top of the stick, stop. Measure the distance from this point to the base of the tree, then add the distance from your eyes to the ground. This should give you a close estimate of the tree's height, but only works well on relatively level ground.

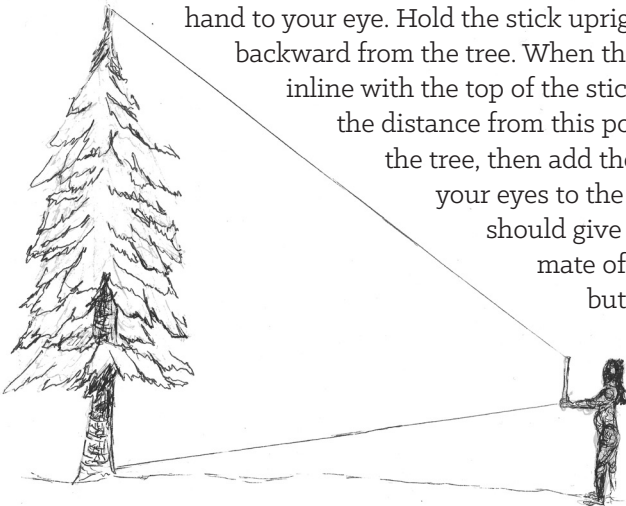

# >>> COMMUNICATIONS

Communications, or coms, usually refers to some form of radio communication for use during actions: cell phones, common FRS radios, FM broadcast, or any number of other specifications. All of these have varying ranges and features, as well as different legal issues that go with their use. Having some of this equipment can be invaluable to action coordination. Used improperly, however, it can be a nightmare.

## COMS TYPES

### CELL PHONES

Cell phones require towers and networks to function, so sometimes their usefulness in backwoods actions is limited—but it's useful during scouting to check for reception of various networks. Pay as you go cell phones can be anonymous. However, with the right

equipment police can listen to the whole conversation, and there is also a location record of your cell phone that can be discovered later in court.

**Range:** Line of sight to a tower—which could be very far away and work fine.

**Pro:** Can call any phone. Everyone already knows how to use them.

**Con:** Batteries that are not easily acquired, which can make backwoods use complicated by requiring a power generation system. Requires a cell tower nearby.

### FRS (FAMILY RADIO SERVICE) AND GMRS (GENERAL MOBILE RADIO SERVICE) RADIOS

FRS and GMRS radios share the first 7 channels and transmit in the UHF spectrum. FRS are lower power (0.5 watt), have 14 channels and

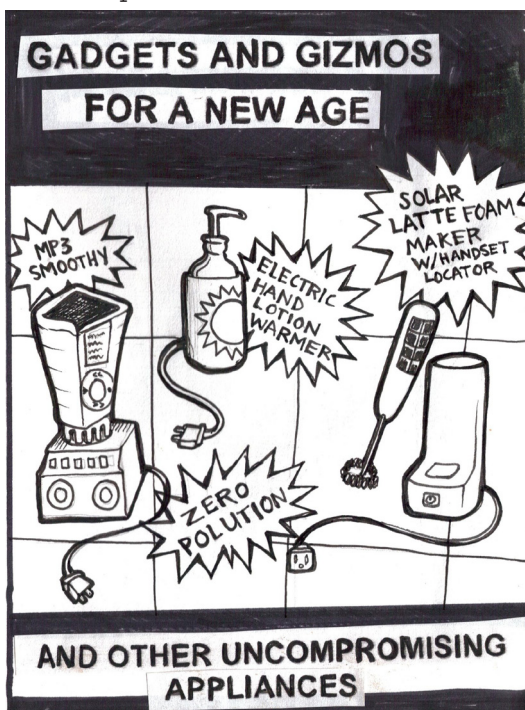

require no license. GMRS have 1-5 watts of transmitting power, have 22 channels and technically require a license from the FCC. These are the radios that an Earth First!er—or soccer mom or snowmobiling yahoo, for that matter—is most likely to use.

**Range:** In buildings and the woods it can vary widely. If you have line of sight, you may get up to 10 miles with the 2 watt transceivers, however, with enough of a hill in the way, you're gonna be out of luck.

**Pro:** Can be purchased everywhere. Cheap. Many have their own charging mechanism for NiCad or NiMH rechargeable batteries and also accept either the rechargeable or the common AA or AAA, so it's easy to carry spares.

**Con:** Anyone can easily listen in. Some have scramblers which only scramble for radios of different brands, and the channels can be busy because of the popularity of these radios—especially a concern for urban actions.

### **CB (CITIZENS BAND) RADIOS**

CB radios are most commonly associated with truckers. Having one might be useful for listening to truck drivers going in and out of resource extraction sites, but CBs aren't recommended for communication between affinity groups. In most situations, GMRS radios will get a longer range.

**Range:** Up to 15 miles, but only if you have a 15' antenna mounted to a car! Handheld CBs will have less range than most handheld FRS or GMRS radios.

**Pro:** Able to listen to truckers.

**Con:** More expensive and larger units than FRS/GMRS radios.

### **UHF (ULTRA HIGH FREQUENCY) RADIOS**

UHF is higher power and has been primarily in business use until recently. Signal properties are similar to the FRS/GMRS radios because they use the same chunk of the UHF spectrum. Most UHF radios are programmable so that channel numbers on a given radio may not correspond to any other radios until set to be so.

**Range:** In buildings and the woods the range can vary widely. If you have line of sight, you may get up to 20 miles with the 5 watt transceivers.

**Pro:** Longer range. Not widely used by the public. Customizable. Higher quality radios than FRS/GMRS.

**Con:** Can be complicated; may require at least one serious nerd in your affinity group. Expensive. If you're thinking about using these,

you probably have someone who knows more about them than we can tell you here.

## **MARINE RADIOS**

Marine radios (in the VHF—Very High Frequency—bands) are only licensed for use at sea. (You wouldn't think about using it on land, would you?) Up to 25 watts of transmitting power.

**Range:** Up to 70 miles (60 nautical miles) if from a large ship mast or shore installation with line of sight.

**Pro:** Lots of power. Good range in some situations, but still require good line of sight to achieve a significant range.

**Con:** Expensive. Illegal for use inland.

## **FM (FREQUENCY MODULATION) BROADCAST**

FM radio is what people listen to music on in their cars. It can be used licensed—though good luck getting a license—or unlicensed—but this is illegal, so you wouldn't do it, right? Pirate FM can be put to excellent use, but is beyond the scope of this small guide. Pirate radio stations have been set up for such diverse uses as broadcasting police communications—thanks to monitoring police scanners—during mass mobilizations to help people stay safe in the streets and out of the clutches of the law, and as relays for communications systems over mountainous or urban terrain unfavorable to handheld radio communication.

## **POLICE SCANNERS**

Police scanners or radio scanners can be used to monitor radio transmissions from a multitude of sources including but not limited to: police, fire, emergency medical services, rail road workers, company security/workers, and other handheld radio users. However, radio technology is quickly developing. Radio communications for emergency services have gone from simple analog to digital trunking and digital encrypted. Police communications have changed too. The communications of smaller police forces will likely be easier to tap into, and simple analog scanners may still work. Larger police forces with larger budgets may require a digital trunking scanner to monitor transmissions, but trunking scanners require some technical know-how to program and operate. Digital encryption for radio transmissions is also unfortunately on the rise. Decryption scanners are illegal, but the technology exists. You may find appropriate online scanners, from pay services to free sites—and even apps for “smart” phones. Do a little research to find the right application for you. In most places there are specific laws for scanner use, so check in with a lawyer if you are concerned with such things. In many states, it is illegal to use scanners while mobile—like in a moving car—but is legal to use them in a home or office.

**Pro:** Can monitor a multitude of kinds of radio transmissions.

**Con:** The cost of good scanners can be high. Requires specialty skills to operate. Illegal for some applications.

## COMS PROTOCOLS

Using some of these basic guidelines will make your broadcast understandable and will ensure that all parties know who is speaking and whether or not the intended recipient got the message. The following is a basic style for communicating on radios that works for the military and works for Greenpeace—and you know, they use radios a lot more than we do. The focus is on minimizing what is said: the less words used, the less batteries used up transmitting, and the less time the channel is clogged for others in your affinity group.

There is a delay on all radios between when the button is pushed and when it starts broadcasting. During an action all we heard was the click of the radio transmission ending from one person because they assumed that we would hear them the instant they pressed the button, and we had no idea people were approaching our location! Wait for at least one second with your finger on the transmit button before talking.

**Over or Out, not both.** During communications over the radio, “over” means that you have finished what you have to say and await response from the person or persons that you are talking with. “Out” means that the conversation is over, and you don’t expect further dialog.

**Copy, not Roger.** Roger is a name; copy is what you say when you mean message received.

**Who, then You.** When you are trying to communicate with someone, state their name at the beginning of each transmission, followed by your own. This tells people who you are trying to reach, and it identifies who you are. This can avoid a lot of confusion.

## SAMPLE CONVERSATION

**“Treesit, Treesit, Lookout, over.”**

(This a shortened way to say, “Treesit? This is the Lookout.” It says that you are trying to reach Treesit, that you are Lookout, and that you await confirmation that Treesit is listening. You should say the name of desired person twice on the initial call in case the beginning gets cut off.

**“Lookout, Treesit copies. Go Ahead”**

(This confirms that Treesit is listening and tells Lookout to continue with message.)

***“Treesit, Lookout, three freddies entering unit 4, over.”***

(This conveys the information while addressing who needs to know. Ending with “over” also communicates that that is the entirety of the message that Lookout has for Treesit and that Lookout expects a response from Treesit)

***“Lookout, Treesit copies. Freddies entering 4, out.”***

(Lookout now knows for certain that Treesit received the information in question. And because they finished with out, everybody else on their channel knows the conversation is over and the line is open and available for them to use.)

Obviously you may not want to actually say things like treesit or lookout, but really that’s up to you. There have been plenty of situations where people were so clever at obfuscating their radio communications that they had no idea what was going on when it came to action time. Find a balance between what you need to say and how much you are going to attempt to keep a secret. Really, if you’re using a radio, there is a good chance it’s not a secret at all.

**WHEN TECHNOLOGY FAILS**

For the Luddites in the group, and because often radio communication is neither dependable nor safe enough, action teams can also create other audio or visual signals for primary or backup communication. Fireworks, signal flares, air horns, car horns, whistles, or calls can be useful in different scenarios. Or, for instance, an affinity group can set up a system where if the scout bikes by with a green hat on, the site is clear and ready for deployment, but a red hat on means stop and reassess.

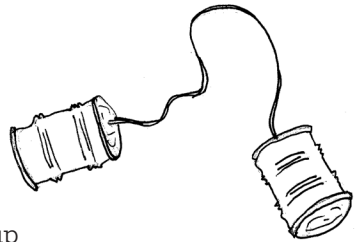

Be creative and always have a back-up plan. Remember that in crucial moments, the technology we have access to is likely to fail us. How many times has a text message taken unpredictably long to reach its destination? Or a walkie-talkie stopped working because of the rain—or because someone walked down the other side of a hill? If a go signal or information about arriving police is important to ensure the safety of your companions, test the communications methods you want to use, and think through the security risks of those technologies.



# >>> ACTION MEDIA

Whether or not mainstream media attention is one of the goals of a particular action or campaign, chances are high that you'll eventually want to communicate with others about what you've done and (sometimes) what you're planning to do. Thinking through the beneficial media possibilities for various kinds of actions is at least as much about getting creative as it is learning to navigate the system of corporate media. Remember that the way we present our ideas to the world can be a provocation or an action itself.

Clarity around your goals for an action, combined with the relevant security concerns, will help to determine what kind of media interactions you'll want to seek. Do you want to alert the media ahead of time—which by default means alerting the police—to get as wide a variety of journalists and photographers present as possible? Do you want to send out press releases and media phone calls once the action is underway—to maintain the element of surprise, while still eliciting mainstream media coverage, recognizing that smaller-scale press are less likely to have the resources to make it there on short notice? Do you want to use only independent media to cover your action in order to maintain complete control of how the action is covered or to maintain anonymity? The nuances of your choices will inevitably depend on the political terrain of where you and your campaign are situated.

## **ENGAGING WITH CORPORATE MEDIA**

If you plan on interacting with the mainstream media, it's important to prepare what you want to say and how you want to depict your action. Remember that not unlike the police, the corporate media is full of their own biases and can distort your words and messages to create more sensational news stories, or simply to further push the narrative that eco-defenders and other radicals are marginal communities with strange subcultural customs and dangerous ideas. In fact, some of the underlying strengths of applying direct action strategies are in the ability to cut through the mediation of someone else representing your position and to create something with the emotional force to reach people even through the muddled words of a news story.

If you want to present a cohesive message to the media, workers on site, and other passersby, think about building an action like writing the narrative for a play. How will it all fit together? What will people see from where they are? How will the different parts and pieces inform each other? Choose your words precisely, and don't be afraid to say what you really mean. Think about the difference between a sign that says,

for instance, “End Police Brutality” and “End Police.” When we create an action, together we open spaces of possibility, and there is so much power in the honesty of what we want and believe we can have.

Use large banners and signs to help convey the content of your message. Think about how they look, and what the aesthetics of the signs will also express. Think about what a photographer or videographer will see, and integrate a visual awareness into the structure of your action. Are there banners close enough to the focal point of your action, the place where the most interesting or spectacular things are happening? For instance, don't send someone up a thirty foot tripod without a banner sized to run down its length.

Remember that although slogans are a great way to transmit your messages quickly and to ensure that people less well-versed on the nuances of the issue have something easy and on-point to say, it can be important to distribute more in-depth fliers or handouts to the people and press in the area to flesh out those ideas and to counter some of the more predictable questions that people may pose about your action. Handouts will also give the media something to draw quotes from, especially if no one is available for, or wants to do, live media interviews.

For each specific action, if multiple people are willing to do live interviews with broadcast or print media, it can be helpful to decide ahead of time on one or two people to be media liaisons—a person or people who will focus on dealing with the media. Because journalists will often quote the least articulate line from an otherwise eloquent monologue, the media liaison(s) should practice using talking points—small sound bites that clearly convey the message and are hard to rearrange to mean something else. The media liaison should also practice refocusing attention on the issues at hand, so that when reporters start asking questions like, “So, where do the people who are up in the tree poop?” The media liaison can respond, “What we're here to talk about is the unconscionable destruction of the last known stand of old growth in this forest.”

Having designated media liaisons can free up the rest of your group to focus on other things, so that someone who is assembling a technical aspect of the action, or trying to make sure that others who are in vulnerable positions have what they need, doesn't also have to make sure the media gets a good quote. Be thoughtful, though, about how the media liaison can come to represent the group. Try to rotate who talks to the media, both to diversify the image of the group and to diversify the skills of self-confidence in speaking built by talking to the media. Balance the need to alternate who acts as media liaison against the long-

term needs for security; in some situations, it may be unwise to rotate through every member of your group, identifying them by face and name to the media and the police. Remember that especially for print media, although reporters will ask for a first and last name that sound real, you don't have to use your legal name.

At big actions, or actions with a lot of media, it may also be nice to have a media wrangler, someone who works solely to corral the media and direct them to the media liaison. At any size action, the media liaison could work with or simply alongside the group's own on-site media team—which may include photographers, videographers, and a photo runner who can run film or memory cards off-site—as well as an off-site media team—which may include people located elsewhere sending press releases, making press calls, and posting updates about the action on internet media.

Press releases are simply a written communication announcing the event to the media. Press releases should be kept under one page with a concise section that describes the action and should include some well thought out quotes that the media can easily pull into their own story. If you want to secure media coverage, first send out a media advisory with the simple “who, what, when, where, and why” a few days in advance so they can plan accordingly. Keep an organized list of media contacts, perhaps separating them out locally, regionally, and nationally.

### **USE YOUR ADVANTAGE**

Whenever possible, scheme on ways to take advantage of your interactions with the media. During the organizing against the G20 in 2009, the Pittsburgh G20 Resistance Project, the group organizing much of the infrastructure for the demonstrations, insisted on only doing live interviews with the media in front of their office space. They painted their website address across the front of the building so that every image of them in the media also directed people to the one source for information about the demonstrations that was fully under their control.



To get the best mainstream media coverage possible, you sometimes have to learn to work different angles. Do some research on the journalists in your area. Depending on what you want, look for writers that have favorably covered similar topics or other kinds of radical events. Or look for lazy writers who consistently include lengthy quotes of your articulately written press releases. Or look for writers who are so politically opposed to what you're doing that they'll always make sure to cover your events because of their outrage.

If you can find sympathetic journalists in your area, it may prove beneficial to develop relationships with them. Building up enough trust, or at least a reputation for delivering interesting stories, can prove to be quite useful. For instance, if you want to have media coverage for an action, but you don't want the police to know the exact location ahead of time, invite a journalist you know to a nearby coffee shop or gas station, and take them to the site of the action once it's underway.

A few years ago, a friend participated in a short-lived, public building occupation that several journalists visited. For the most part, few people would talk to them. After tailing one of the journalists throughout the building, preventing him from taking pictures of people who didn't want their picture taken, he exasperatedly asked her why people were doing this occupation in such a public way but refused to talk with the media. Against her better judgement, she gave him a lengthy interview with her thoughts and feelings about it. A few hours later, she was arrested at the building in a dramatic police raid, and on her way to the police station where she would be charged with breaking and entering, she frantically texted her friends to get in touch with that journalist to beg him to pull her name from the story. Her friends were relieved to not only be able to reach the journalist, but also convince him that it would go against his journalistic integrity to run her name in the story, so that it was one less thing she had to worry about when she got out of jail.

### **BE THE MEDIA YOU WISH TO SEE IN THE WORLD**

The internet is increasingly becoming a primary source for people to get their news about what's happening, from mainstream news online and independent blogs to social media networks like facebook, twitter, and instagram. With corporate control of the most popular websites and increasing government surveillance, it's not exactly the accessible dream of the indymedia generation. However, whether using the internet or other low-tech means, it is of crucial importance that we take control of how our ideas and actions are expressed.

To ensure the coverage that you want, document your actions with your own photographers and videographers. This can also function to limit

police violence and can sometimes be useful in fighting resulting legal charges. Beware that photographers may accidentally catch pictures of people doing illegal things that could then be used against those people if made public. Additionally, digital cameras leave embedded codes in the pictures they produce that can be traced back to the camera they came from; be conscientious of this when posting pictures online with some desired anonymity.

Whether using your group's own website or blog, posting to other independent news sources, or relying on social media, there are a host of legal and computer security concerns to be aware of. Check out **Computer Security** for more information, and have explicit conversations with those you organize with about the risks and benefits of the various media options. Be especially careful incorporating live streaming into the media coverage of an action; because it broadcasts across the internet without a filter or time for editing, there is no way to un-publicize anything caught on film.

Radio on the internet, whether through streaming radio or pre-recorded podcast programs, have also become a popular form of independent media. Use radio to publicize your events or actions. Live radio, whether streaming on the internet or set up as pirate radio stations, can be great to keep listeners up-to-date at large actions or demonstrations about exciting developments, police movements, and arrests.

It's important that at least some of your media efforts exist in the public space of our shared world, off the internet, both to increase the



Media relations in Taksim Square during the 2013 Turkish uprising

accessibility of accessibility of your messaging and the precision of achieving your targeted audience. Hanging up or handing out flyers, wheatpasting posters, and graffiti can help you communicate directly with people who work in particular locations, shop in a certain place, live in a specific area, and share a certain geography. There is power in creating propaganda that impacts the landscape we occupy, that visually breaks up the daily routines of our lives, and pushes people to grapple with questions some would rather leave unspoken. Sometimes the medium is ultimately the message.

After the widespread uprisings in Greece in 2008, anarchists visited to share about what had occurred, and during their talk, a friend asked how they advertised their events and demonstrations. One of the Greek anarchists said they posted literally hundreds of fliers for each event they organized, and that whenever something notable happened, politically or socially, a variety of different anarchist groups in their city each made fliers commenting on their specific political perspective. The Greek anarchists described creating a massive amount of propaganda. After the talk, the friend who originally asked the question became determined to post two hundred fliers for every anarchist event that happened, and quickly the city became covered with posters about events to come and pressing issues for people to discuss. I meant to take a picture to bring with me when I traveled to Greece to show the anarchists who had visited how their talk had inspired my friend to out-do the notorious flyering skills of Athens. When I arrived to the central square of Exarcheia, my jaw dropped. The first thing I saw was an old man covering the entire square with twelve foot tall posters advertising for an upcoming demonstration with a giant mop and bucket of wheatpaste. They were not kidding.

### **ADVANCED MEDIA STRATEGY**

In the early 1980s, a group of anarchists on the West Coast heard that the governor of their state was going to make an appearance in a town near them. This was to be a particularly odious occasion, as the governor would be outlining his plan to extend mandatory minimum prison sentences. The anarchists knew this demanded some kind of response, but everything in their repertoire felt scripted. Should they be disruptive with banners and noisemakers? Print radical pamphlets calling for an end to prisons? Try to hit the governor with a pie on his way to the podium? They must have been discouraged by the predictability of all these possible responses. And in talking about their dissatisfaction with these limits, they stumbled on a way to turn the situation around. On the day of the speech, they hit the governor with the pie. Banana cream, right in the face. The pie-throwers screamed “criminal!” as they made their dashing escape. There was a coordinated banner-drop across

the street calling for the imprisonment of all politicians, and they sent a letter to the media elaborating their position and threatening further action. So far, par for the course.

There was the predictable flurry of reaction. People were outraged, the governor was furious, and the media covered it all. But this time, the anarchists were secretly leading the charge. They posted a large ad in the paper with a photo of the pie-faced governor, along with a stern statement calling for the arrest of the hooligans responsible as well as a plea for donations that would serve as a reward for information leading to the capture of the criminals. The money came in, and they used it to print more ads with particularly embarrassing pie-faced photos of the governor, along with more requests for money. Their “organization” did radio interviews over the phone, and they published statements that responded with grossly inarticulate and incendiary language to prescient, well-written, and unusually long quotes included from anarchist material. The cycle continued, until the organization leading the charge against the anarchists was calling for the imprisonment of everyone and had circulated more quotations from anarchists than anyone would otherwise have seen. And now everyone knew about the pieing, because they’d plastered photo after photo all over the place.



Indigenous warriors pose with stolen Olympic flag in protest of Vancouver Olympics on stolen land, 2010.



# >>> ACTION LEGAL

## *Tips for successful legal support*

Legal support is important for the success and sustainability of our movements. The criminal justice system is designed to isolate and disempower people, but with support in jail and through the court process, we can find collective empowerment in our legal battles against the State. Without legal support, people are likely to feel demoralized at best and to get locked up at worst. Good legal support can keep people physically and legally safe, help arrestees achieve their goals, and make protests more effective.

## PREPARING FOR AN ACTION

### **FIGURE BAIL MONEY INTO THE COST OF YOUR ACTION**

When planning an action where arrests are possible, fundraise ahead of time to put money aside for bail or bond. Assess your collective resources, especially the money that you could access for a short-term or long-term loan, and communicate your capacity to the larger group. If intentional arrests are a part of the plan, communicating the desired number of arrests and the group's ability to do long-term legal support can help motivate people to put themselves in arrestable positions without encouraging numbers of people to intentionally get arrested beyond the scope of what you are prepared for.

If you post bail to get someone out of jail, you will get that full amount of money back once the court process is over—as long as they show up for all their court dates. If you can't raise the full amount for bail, you can post between 5-15% of the bail through a bail bondsman. However, that is money that the court system keeps, and bail bonds are not available in all court systems. That said, gathering the money to post bail will be more economical in the long run.

If arrests are likely a part of your action, consider putting a system in place ahead of time to send out a plea for money and receive funds, too. Will it be the media team's job to post the plea for money, or the legal team's? Are there wealthier liberal or progressive networks you can send the plea to? Is there an existing paypal or bank account where the money can go temporarily? If you're planning to borrow money for bail, does the legal team know who to ask and do they have a plan for getting money in cash after the banks close?

## DO YOUR RESEARCH

Try to get information about what charges arrestees are likely to face. Certainly, the police will begin with the highest charges possible and will often drop them later to lesser charges, but gathering as much information as possible will help people make informed decisions. For instance, will a demonstration at a Federal building automatically mean Federal charges? Will newer laws about energy and infrastructure indicate felony charges rather than misdemeanors?

Research the municipal or state codes regarding relevant things like the wearing of masks, the allowed dimensions of wooden poles for signs, marching without a permit, graffiti and vandalism—especially in consideration of anti-gang laws. Also, research the court system in your district so you know where arrestees will be taken for holding, processing, and release. Talk to older radicals in your area or do news searches to get a sense of the precedents for police responses to similar kinds of actions.



When possible, consult a lawyer beforehand about the action you're planning. If you tell a lawyer the details of how you plan to break the law before you do so, legally they can be implicated in your crime and cannot represent you in court. However, you can ask questions theoretically about what would happen to someone caught engaging in the kinds of activities you want to engage in, at the kinds of places you want to go to. Develop relationships with specific lawyers who can research potential legal repercussions, and they will help you navigate this vague terrain.

To find sympathetic lawyers, connect with progressive legal organizations, like the National Lawyers Guild and the ACLU, as well as public defenders and individual lawyers who might be interested in offering support. Most lawyers, though, are used to working hierarchically and can cause problems when it comes to decision-making and information sharing. Try to identify and deal with any power dynamic imbalances and control issues before the action.

## EDUCATE YOURSELF AND EACH OTHER

It's best if everyone involved in the action knows their rights, knows how to deal with the cops, and knows what to expect from the legal

process before the action. Organize Know Your Rights trainings and Legal Observer trainings ahead of time. Have conversations with people planning to intentionally get arrested, in your affinity group, or in action planning teams about the possibility of jail solidarity and about whether they want to get bailed out immediately or wait in jail for a bail reduction hearing or another opportunity to be released without bail.

## DURING THE ACTION

### IN THE STREETS

It's important to have legal team members and legal observers on the streets. Make sure someone is in the places where civil disobedience and/or mass arrests are occurring in order to act as a police liaison (if there isn't one already), take notes about who is getting arrested and how, and to document police misconduct including the names and/or badge numbers of the cops. Legal team members can be available to pass out the legal number and can give updates to demonstrators on police movements, numbers of arrests, and activity in the courts, as well as calling the legal office with updates from the streets.

Having National Lawyers Guild trained legal observers—the ones wearing the bright green hats—can be beneficial. If you can outsource the role of legal observer to trusted, NLG-trained observers, that is one less role that your action team must fill. Additionally, like with the presence of corporate press, official legal observers can help to show that people from a variety of sectors of society care about the safety of protestors and may function to restrain the actions of the police. Video and photo documentation can similarly lessen the violence of the police response—and can sometimes be useful later in court, but can also be subpoenaed to use as evidence. So, if you are photographing a demonstration, be prepared to refuse to turn over the pictures—and risk sitting in jail with contempt charges—to keep your comrades safe.

### OFFSITE LEGAL TEAM

The offsite legal team is responsible for putting systems in place to track everyone who is arrested during the action until they are released. The legal team should create or print legal forms for people to fill out before the action—see **Contacts and Resources** for an example, should set up a legal office or other offsite space they can work from, and should set up and distribute the number for a legal line—a landline or other phone line that can accept collect calls from the jail.

When setting up an off-site space for the legal office, find someplace safe and quiet that you have easy 24-hour access to with a phone line that

will work as the legal line. If using anything other than a landline, make sure to test your legal line ahead of time! Make sure to have plenty of office supplies like notebooks and pens, markers, butcher paper, staplers, and paper clips. Keep pre-made forms like an arrest roster and copies of Jail Outtake forms on hand.

Make sure to research ahead of time a list of the contact information you'll need, including:

- >> Local Jail (Central Booking, Local Precincts, Main Jail, Juvenile Justice Center, etc.)
- >> Court clerk and bail clerk
- >> On-call attorneys and emergency specialist attorneys (e.g. immigration attorneys).
- >> Public Defender's Office
- >> Legal Observers / Police Liaisons / any other contacts at the action
- >> Bail Bondsmen
- >> People to target with a call-in campaign (e.g. Police Chief, Mayor, District Attorney)

Also keep in the office: maps of the city (and street maps to give out to legal observers/runners), information about the public transportation system, and information about the closest hospitals and free clinics.

### **ANSWERING THE LEGAL LINE**

When answering the legal line, you'll be gathering a lot of information, some useless, some critical. Keeping all of this information organized is crucial. For example, if you are asking a lawyer to visit your friends in jail, you should be able to give them all the arrestee details available (names, birth dates, jail ID#'s, and special needs). Take good notes. For every call, get the caller's name and phone number, record the time and date, and write legibly. Keep all your notes in one notebook so there's a chronological log of all calls you received and made.

When people are in the streets, you'll get updates and occasionally reports of arrests. Protests are usually a little chaotic, so you might get calls with confusing or conflicting information. It's important to be clear what information is confirmed and what is a rumor. For example, when the police surround a group, you'll get calls saying everyone was arrested, but some may be detained then released on the spot. Ask callers to be specific about what they see so you can verify it. Don't expect to know exactly what is happening; just keep clear what is confirmed and what is not.

Once the arrests start, the legal line will be busier with supporters calling in, and eventually arrestees calling from jail. Besides the primary task of collecting arrestee information, this is a good time to clarify the stories you've gotten about numbers of arrests and incidents of police misconduct and to do rumor control by providing callers with confirmed information.

Provide emotional support when talking with arrestees and family or friends of arrestees. Remember that arrestees may be going through something traumatic and may be exhausted or scared. You are probably the best source of information for people in jail, and may be the only friendly person they have to talk to. Make sure to ask them if they need anything; offer positive feedback and reassurances. Keep in mind your own emotional well-being, too, because if you lose your cool you won't be able to be supportive for arrestees.

Tracking people in custody so that no one gets lost in the system is relatively simple. This is especially important for people the cops tend to target, including people seen as organizers, people accused of militant actions, people of color, and transgender people. With full legal name and birth date, you can call the jail and get information on charges, bail, and expected release time. A benefit of doing legal support for a small group who is planning on risking arrest is that you can get a list of names and special needs before the action even happens.

Someone can be hard to track in the system if they've been separated from others for special questioning or punishment, if the cops misspelled their name—which is more common for non-european names—or if they've been taken to the hospital or juvenile hall. If you can't get information about someone, a parent, legal guardian, or lawyer might be able to. If you don't know the arrestees' names—or if you aren't sure they're giving their names, you can try just asking the jail for info on “the protesters” and they'll usually know who you mean. Sometimes officers will give you incorrect information, especially about when people will be released. If you end up talking to a jerk, call back in an hour—you'll likely get someone different.

Be available to answer the hotline 24-hours a day while people are in jail. In some cities, people charged with a misdemeanor may be released with no bail, and protesters rarely spend more than a day in jail unless they have more severe charges. Often arrestees are so relieved to be out of jail that they forget to call you to tell you they've been released. Ideally, someone can wait at the jail for everyone to be released and have arrestees fill out an outake form with their contact info and next court date. Unless you get confirmation that they've been released, assume arrestees are still in custody.

Once everyone is out, schedule a meeting for arrestees sometime before the first court date. It's not uncommon for everyone's charges to get dropped at their first hearing, but it's good to be prepared in case they do go forward.

### **DEALING WITH EMERGENCIES**

Emergency situations can be anything from someone being denied access to medicine or medical attention, to an undocumented individual being turned over to the Immigration and Customs Enforcement, to mistreatment like people being beaten in their cells. The most important thing to do when situations arise is to stay calm and take immediate action. Keep in mind that the priority is helping the people in jail get out safely, and that other concerns can wait until the emergency situation is over.

If you know that a demonstrator is particularly at-risk for being fucked with by the police, it's best to plan ahead and prepare for the worst. This means locating attorneys or organizations who specialize in dealing with the sorts of issues you're anticipating. For example, if you're supporting a demonstration with undocumented participants, have an immigration attorney ready to help out if an arrestee's citizenship becomes an issue.

For example, once at a demonstration, a transgendered woman (MTF) was arrested and placed in the men's section of the jail, in a common bunk room with no walls. She felt unsafe and was pretty upset about being there. A national transgendered rights organization helped to find an attorney who knew the local laws regarding transgendered inmates. They called the jail, and got the individual moved out of the men's block.

Calling an attorney to make a phone call or visit the jail is usually the best and most effective way to solve legal emergencies, but sometimes it doesn't work. You can also try to help resolve emergencies by organizing a pressure call campaign or using the media to create political pressure. Keep other arrestees calm and let them know what they can do to help, like using non-compliance tactics to put the pressure on from inside.

### **OUTSIDE THE JAIL**

From the jail, the legal office or elsewhere, continue to fundraise for bail, put together a call-in campaign to pressure the mayor or police chief, or help organize a vigil at the jail to help ensure a speedy release for all arrestees. Having some—or lots—of folks waiting at the jail to receive arrestees being released is an important part of offering emotional and moral support, and this is an important time to gather follow-up information. Come prepared with delicious food for the arrestees and ways to help everyone find the rides home they need.

When receiving arrestees released from jail, make sure to have everyone fill out a Jail Outtake form detailing information including: name/nickname, arrest time, arrest location, where detained, gender, emergency contact, booking number or case number, if they asked to see legal team or lawyer inside (and if so, when and how many times?), specific charges, arraignment, pretrial or other hearing date, and bail or conditions of release. When receiving arrestees from jail, also:

- >> Have everyone fill out police misconduct reports
- >> Photograph/videotape and document injuries
- >> Take statements on tape recorder
- >> Give people being released information about continuing contacts for the legal team and access to medical care they might need
- >> Call legal office with updates

### **IN IT TO WIN IT**

After everyone is out, the long-term legal support begins. This can include finding lawyers to represent people, organizing meetings for arrestees and supporters, and organizing people to come to court dates. It can also include continued fundraising and putting together a media strategy—from support websites, to independent media, and appealing to mainstream media with events like rallies outside court dates and with letters to the editor. In some cases, legal support can also mean doing work for attorneys, like gathering witness information and evidence.

People arrested together often choose to tackle the legal system together. If so, communication amongst co-defendants is key. Meetings of co-defendants with their lawyers and with each other are important for discussing and coordinating legal and political strategies, and supporting that process could simply mean cooking meals and providing rides to and from the meetings. If you commit to organizing defendants' long-term legal support, know that you could be doing it for months or even years—and know that the support you offer can be the difference between building resiliency and collapsing in the face of state repression.





Buffalo Field Campaign shuts down buffalo capture facility in West Yellowstone, MT



# 3

## SOUND OF THE POLICE

*Police break up a body blockade at a mine site on Sami lands currently occupied by Sweden, 2013*

# >>>KNOW YOUR RIGHTS

Cops are allowed to lie—about anything. Cops are even allowed to lie about being cops, especially when they're acting as an undercover. As undercovers—and often in uniform, too—cops are allowed to break the law. This isn't entrapment. The entrapment defense is almost impossible to use successfully, because the cops have to coerce you into breaking the law, and you have to look like an angel to the jury.

Remember friends, cops can and will lie. Never trust a cop, don't answer their questions, and never ever snitch.

## **DON'T TALK TO THE POLICE**

When dealing with the police, always remember the Magic Words: ***“I am going to remain silent. I want to see a lawyer.”*** Once you invoke your right to remain silent, they are supposed to stop questioning you. It sounds super formal, but it is clear and the legally safest language. If you can, say it loudly enough for witnesses to hear it.

Your Miranda Rights—“you have the right to remain silent, anything you say can and will be used against you...”—is the only good advice you'll ever get from cops. Shut up! They only have to read you your rights if you are both under arrest or detained and being questioned. But anything you say to cops at any time can be used against you in court. Be very careful about trying to talk your way out of things. A lot of lawyers say a case is lost when their client talks.

Don't sign anything except a citation (i.e. a traffic ticket). A citation is a promise to show up in court—it will say at the bottom, “A signature is not an admission of guilt.”

The Magic Words are not cure-alls, but they are legal band-aids. You might still get arrested, but you'll have a better chance in court.

## **IDENTIFICATION**

In the US, there's no law requiring you to carry identification. You only need to carry ID when you're driving or if you aren't a US citizen—or potentially as a specific condition of your parole or probation. If the cops are giving you a citation, you don't have to show your ID, but it speeds things up. If you do not have ID when receiving a citation, they can book you—take you to jail, fingerprint you, take your photo—and keep you in jail until they can confirm your identity or until your trial.

Some areas—like the whole state of Texas—require you to have ID if you're arrested, but you can't be arrested just for not having ID. As of 2012, 24

states had stop-and-identify laws, which legally allow the police to request ID only if they have “reasonable suspicion” that you were involved in criminal activity. Unless you are being detained, police are not allowed to require ID without reasonable suspicion.

### **WHEN STOPPED BY THE POLICE**

There are three levels of interactions with the police: Casual Questioning (or conversation), Detainment, and Arrest. For each interaction, the levels of suspicion required are: Casual questioning/none, Detainment/reasonable suspicion, and Arrest/probable cause.

When stopped by the police, first ask if you’re being detained. If you are not, leave. If you are, ask why you’re being detained, then say the Magic Words: **“I am going to remain silent. I want to see a lawyer.”** Sometimes the cops will say you’re getting arrested just to get you talking. Don’t participate in casual conversation with cops. They will use this information against you and your friends. Sometimes the safest option for people on the street is to give your name and birth date, but nothing of any substance—not where you’re coming from, who you work for or who your friends are.

How you talk to cops and what you say will probably be different based on how you’re seen by the police—like if you are white or otherwise privileged, or where you are—like if you are alone in a dark alley versus if you are on a crowded street in the middle of the day. Trust yourself and your intuition when deciding how to keep yourself safe physically as well as legally.

If I’m a police liaison, I am going to talk the cops; it’s my job. If I’m copwatching, I might ask the cops what’s going on. In reality, I don’t say the Magic Words every time I see or interact with a cop, but in these situations, I’m not having a “casual conversation,” and I am not answering questions. If I am being questioned and/or detained anywhere, if I am at a political rally, march, or action, if I am being arrested, I don’t say anything to the cops except the Magic Words.

### **SEARCH**

If the cops try to search you, use Magic Words 2: **“I do not consent to a search.”** Again, try to say it loudly and often enough for witnesses to hear it. It sounds formal, but again, it is the legally safest thing to say. If you say something like, “I’d rather you didn’t search my bag,” the cops can testify that you reluctantly gave consent. Using the magic words might not prevent them from searching you, but if they search you anyway and find something incriminating, it should technically be thrown out in court—in legalese, “be declared inadmissible.”

If the cops are doing a lawful search, it doesn't matter whether you consent. If it's an unlawful search and you do not consent, they technically can't use the evidence in court. However, if it's an unlawful search but you do consent, then they can use the evidence in court.

Even if there's nothing illegal or incriminating in your bag when you hand it to the cops, when they get it they might plant something: find something illegal you didn't know about, like marijuana seeds; find something technically illegal, like a knife; something that gives them a new line of questioning, like a flyer for last week's protest; or sensitive information, like your address book. Cops make it sound like it'll be quicker and easier if you cooperate with them, but letting them search your bags never makes things quicker or easier.

If you are being detained, cops can pat you down to see if you have any weapons if they feel threatened. If they feel something suspicious on your person or in a bag that you can immediately access, they can search that specific area, but not anywhere else.

If the cops feel something illegal that's not a weapon while legally patting you down—like a vial of crack—they can arrest you for it. If you are being arrested, they can search your bags, and in some circumstances strip search you.

## **SEARCH WARRANTS**

If the Feds come to your door with a search warrant, go outside and lock the door behind you. Read the warrant and look for the address, date and time, and signature. Even if it looks legit, there might be something wrong with it that a lawyer will find later. The warrant should be dated, and while there's no hard and fast rule, a warrant more than a month old is usually considered illegitimate, and searches are generally made within two weeks of the warrant being signed. Search warrants also have a range of hours the cops can come—sometimes just day or night, but if the cops come outside that range, technically, they can't search.

The warrant is usually for a specific area and for a specific thing. A warrant might only be to look for stolen goods in one bedroom of a house. Unless the cops see something illegal on the way to that bedroom, they aren't supposed to go into the rest of the house, but there's nothing physically stopping them from searching just because you've shown the warrant is not legit. They still have the physical ability to charge in and look around, but whatever they find will possibly be thrown out later in court.

Always say Magic Words 2: ***"I do not consent to a search."*** It's the legally safest thing to say. If you say, "I'd rather not have you search my house," again, the cops can say that you reluctantly gave consent.

Remember, the cops will lie to get you to consent to a search. The cops may say there are exigent circumstances so that you'll consent to a search, but if they really had exigent circumstances, they wouldn't bother with consent—they'd just kick down the door. The cops aren't legally allowed to make threats to convince you to give consent, but saying they'll get a search warrant isn't a threat.

Physically blocking the cops is probably not a good idea. There are slim odds that you can fight off the cops, and you'll likely get hurt or arrested and the cops will still get inside. If the cops come, try to record everything they say—write everything down and take pictures or video. Call neighbors or other friends to come and be witnesses, and have a lawyer on the phone if possible.

### **ARREST WARRANTS**

If the cops come to your house with an arrest warrant for you, rather than a search warrant for the house, and you agree to go with them, they may try to trick you by encouraging you to get your coat or use the bathroom. Once you are in the cops' custody, they can't let you out of their custody. This means that if you go back inside to use the bathroom, the cops can follow you in and search the



apartment. Legally, any evidence that is in “plain sight” can be used against you in court, and to protect themselves, the cops can search anything within “lunging distance.” The argument is that you could lunge for a hidden weapon and attack them with it. In a typical room, all four walls are within lunging distance of the middle. So the cops can take as evidence anything that is in plain view after they've torn your place apart.

If the cops come to your door with an arrest warrant and know you're inside, don't hide—they can just break in. Go outside immediately and close the door behind you. Don't go back in for your jacket, the bathroom, or anything. Cops often wait until they know you're home before they arrest you, just so they can have a chance at searching your home. In a lot of places cops don't use physical warrants. The cops just get a notice on their computers with the information, and no paper is involved, so don't expect the cops to always have a form to show you.

### **GETTING QUESTIONED**

The cops will deliberately try to find a cop who's the same age/race/gender as you are to question you or to be the “good cop”. Often they will play the

good cop/bad cop game when you're tired, scared, cold, hungry, thirsty, don't understand what's happening, and haven't gone to the bathroom in a long time. Just remember, there are no good cops, and they always lie to get you to talk with them. Use the Magic Words: **"I am going to remain silent. I want to see a lawyer."**

The cops will take what you say and twist it into something incriminating against you or your friends. Even if you think you're innocent, you might admit to something that's technically illegal. Or they can convince you that you've admitted to something illegal, and then get you to try to explain your way out of it, thereby giving them more information about you, your work, and your friends. If you really want to talk, at least make sure to have a lawyer present during questioning.

The best option is to remain silent and demand to see a lawyer. If you say anything to the cops after saying the Magic Words, like asking to go to the bathroom or have your cuffs loosened, legally, you turn your rights off like a light switch, and they can directly question you. You can solve this problem simply by re-invoking your rights—just say the Magic Words again. It's never too late to re-invoke your rights, no matter what they say, but avoid turning your rights on and off. Be consistent. Say "I am going to remain silent," and do it. Remember also that it's useless to plea bargain with cops, because they don't have power to cut you a deal. Cops will lie about this, but they only have the power to question you, arrest you, and suggestion charges, after that, it's up to the magistrate and judges.

## **PREPARING FOR ARREST**

How do we figure out what we might get charged with when planning an action? Possible charges vary immensely from jurisdiction to jurisdiction, and punishment varies from offender to offender within jurisdictions. Thus, accurate answers are difficult to give. Most people engaged in garden variety civil disobedience will not be charged with serious crimes. If you are engaged in more exceptional crimes, there are a range of factors to consider.

As for the common question regarding **misdemeanor vs. felony**: it is difficult to give solid examples of what charge will be a felony and what charge a misdemeanor. In general, considerations such as damage to property, resisting the police, and the use of bodily fluids factor into the calculation. If property is damaged, damage in excess of \$250 dollars is probably a felony. If a person is seriously injured, that is probably a felony. If a weapon is used, that is probably a felony.

In most jurisdictions, **misdemeanors** are crimes punishable by up to a year in jail, and felonies are crimes punishable by over a year in prison.



**Felony convictions** carry collateral consequences that change from jurisdiction to jurisdiction, like loss of gun rights or loss of voting rights. Also, if you are not a U.S. citizen, criminal convictions can sometimes lead to deportations.

Consider your criminal history. The more convictions an arrestee has had in the past, the more serious the punishment may be. Remember that convictions are not arrests. With a misdemeanor charge, if you have never been convicted before, you will probably be given a slap on the wrist, consisting of community service, fines, and/or probation for six months to two years. If you have several prior convictions, you could go to jail for 15-60 days for a misdemeanor charge. With felony charges, prior convictions cause a much more rapid increase in punishment.

Consider whether you will be charged with federal or state charges. This is a total crap shoot. In most places, you can be charged with state crimes on federal land and federal crimes on state land. Many people believe otherwise, but they are wrong. Normally, the feds will not get involved, but if they do, federal crimes carry heightened penalties of jail and probation. For a total scare factor, you can actually be prosecuted and punished twice for the same act in state court and federal court. This is rare, but can happen—like when a state threatened to prosecute a mink liberator, after he received a relatively light slap-on-the-wrist two-year federal prison sentence for a mink liberation crime-spree rampage. Or like when an anarchist arsonist was tried federally for a violation of their supervised release after all charges were dropped at the state level.

## **COMMON CHARGES EXPLAINED**

**Disorderly Conduct.** This means just about any action that could possibly offend a hypothetical little old lady. Disorderly conduct is probably defined extremely broadly in your jurisdiction. The definition is probably something similar to “recklessly creating the risk of annoyance or alarm in another by failing to obey a lawful order or by making loud noise, fighting, or rowdy and tumultuous behavior.” Note, you only have to “recklessly” create the “risk of annoyance” by “rowdy behavior.” You don’t even have to actually create annoyance, just the risk thereof. Most Earth Firsters “risk” creating “annoyance” every time they open their mouths.

**Trespass.** This means entering a closed-to-the-public place where you have no right to be—for example, someone’s backyard. Or entering an open-to-the-public place after you have been lawfully directed to not enter—for example, a shopping mall after being previously told to never come back. If you do either of the above, you are guilty of trespass even if you leave before the cops show up.

**Interfering with Traffic/Blockading a Road.** Umm, you get a gold star if you can guess what conduct those crimes prohibit. Those charges aren’t that serious but can still carry jail, fines, and probation. Think before

you spontaneously decide to sit down and block that road. It is a crime. However, if a bulldozer is about to tear up that garden your neighborhood created or beautiful, ancient foliage, then by all means necessary, steel your gaze, sit your ass down, and grab your lover's arm. But it is a crime.

**Breaking a Closure Order.** This is a federal crime. It means trespassing onto a public lands' area where the government has issued a "closure" order. Closure order means an order to not enter or use the area. Many closure orders are unlawful, but you can still be arrested for violating them.

**Criminal Mischief.** This is a state crime that means recklessly, knowingly, or intentionally damaging someone else's property without the right to do so—for example, cutting open a forest road gate to get a truck in to put up a treesit. In most jurisdictions, once the damage tops about \$250 dollars, it becomes felony criminal mischief. That sure makes it sound tougher when relating your rap sheet to future employers—if there are employers in the future.

**Damaging Public Property.** This is a federal crime that means the same thing as criminal mischief but the damage is to government property. For example, digging up a Forest Service road, cutting a Bureau of Land Management gate, despoiling the White House fence, or cutting down the Forest Service's genetically modified tree test site.

**Resisting Arrest/Assault on an Officer.** Those charges happen in four situations. First, when someone passively resists arrest by thrashing about. Second, when someone goes completely limp and the cops get pissed off. Although the charge will not stick at trial unless the cops lie, and a cop lying in court is not an unlikely event. Third, when somebody fights or wrestles with the cops when they are trying to arrest the person. Fourth, the most reliable way that people get charged with resisting or cop assault is...when the cops beat or rough you up. You get beat up and you get the increased charges with resisting or assault because the cops have to justify their use of force somehow. You get beat up and the increased charge. The police are shit.

**Possession of a Controlled Substance/Unlawful Possession of a Concealed Weapon.** If you are going to be in a situation where you will or may be arrested or searched, clean out your pockets. Clean. Out. Your. Pockets. Possession is a stupid—yet, apparently popular—way to catch some serious criminal convictions for no good reason and to cast a bad light on the campaign/action. If you are a felon, possession of a weapon may result in years of prison. Note that ordinary pocket knives are unlikely to be considered concealed weapons. However, some jurisdictions do consider knives that swing out easily to be illegal if concealed in a pocket. A switch

blade with a spring would also count. Some places have inch limits, some do not. There is no universal four inch rule.

**SLAPP (Strategic Lawsuits Against Public Participation) Suits.** Although this is not a criminal charge, it is important for those involved in campaigns targeting specific corporations to understand. SLAPP suits are civil suits pressed by corporations against those who publicly criticize a corporation's behavior. SLAPP suits can target groups or specific individuals—including Jane and John Does, meaning anyone. SLAPP suits rarely prevail in court, but their goal is to intimidate and silence their opposition by threatening legal recourse if protesting continues.

### ONCE YOU'RE ARRESTED

Okay. You have been arrested and are in a cop mobile. What happens next? It is hard to be 100% certain. What follows, however, is likely.

You will be transported to a station house or county jail. There, you will be put through intake, where they will get your basic identifying information, finger prints, and will inventory your possessions. If you have a closed container that the police have not previously searched, they will probably search it during the inventory. Hopefully, you don't have any contraband in it. The intake and inventory process will probably take an hour or three while you sit at a desk, bench, or in a holding-cell-drunk-tank. You can either cooperate or not. If you refuse to cooperate, you will be a pain in the ass to the cops. You may not be released as quickly, and they may physically attack you in retribution, to force you to comply with fingerprinting, and to take your stuff. However, they may also release you without charges, especially if you are not cooperating along with other activists. As well, you may get some big money

### LEGAL STEPS AND CHOICES

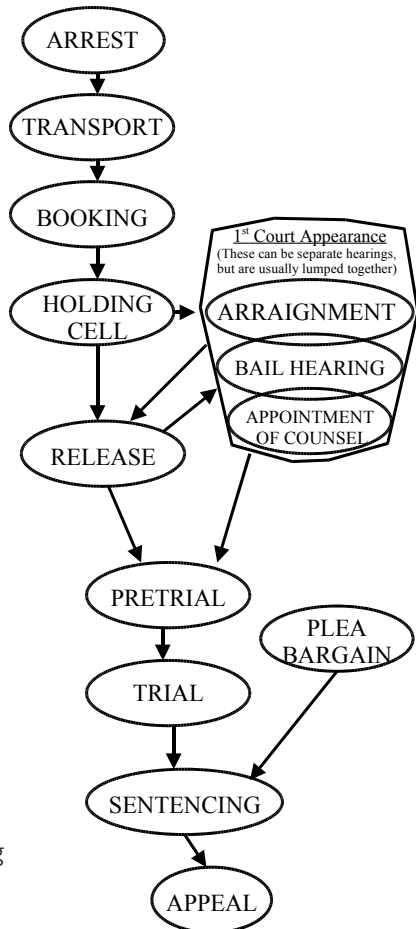

civil-rights settlements years down the road for any misconduct. If the cops injure you or treat you badly in jail, talk to a civil rights lawyer. If you get any money, share some of it with your comrades for more badass direct action projects.

The state may release you on bail or without you having to post any money—called *on your own recognizance*. If the cops are going to detain you for more than a day or two, they will probably delouse you with non-organic anti-hippy soap and take your clothes. You will get a bright orange, light blue, or—if you are lucky—pink pajama outfit complete with ninja shoes. The outfit will have a bad stencil on it—which may be comforting to some of you punks out there. If they do not take your clothes, you will probably be released pretty soon. Inmate pajamas are normally only given when a person is leaving intake and holding and sent to county, jail, or detention.

Within 48 hours, you should be given a court hearing. If you were previously released, this hearing may be set in the future. At the hearing, you can ask for a public defender attorney or have your own show up. This hearing is normally where you will learn your initial charges. If you have not been released yet, you may be released on bail or without having to post any money. If you fail to return to court, the bail money will be forfeited. From here, your court case begins. Ask your lawyer for more information.

If law enforcement tries to ask you any questions in jail about yourself, the actions, the issues, or others, invoke your right to remain silent. Say the Magic Words, **“I am going to remain silent. I want to see a lawyer.”** The cops are not your friends and are only trying to gather more information to put you and your friends in jail.

## **LAWYERS, COURT, PUNISHMENT**

When dealing with lawyers, especially public defenders, don't let them pressure you into taking a deal. You may want to have a trial just for the fun of it or to publicize the protest action. If you are being charged for a cause that is popular in the area with the court, for example protecting old growth forest in Portland, Oregon, a jury may acquit you even though you are guilty as hell. Try to be honest, open, and respectful with your attorney, but also, don't take any bullshit.

Be patient with your lawyer. Don't call them everyday, but if they do not call you back, ask them what the policy is. For example, I try to call clients back within 24 hours. If you don't understand something, ask your lawyer questions. If they don't answer your questions, or you don't understand the answer, tell them that you need more information. Don't tell them that you understand something that you don't. Don't sign any papers that you don't understand.

If you break the law, you may catch some jail time. Or if you break the law big time, you may catch some prison time. That is a reality. It is not as bad as the media makes it, but it still is a shit hole. Enough said. Ask a local attorney for more specific information on what kind of punishment could be expected and what the options are.

One option might be probation, but probation sucks. It is a blood-sucking, time-sucking, guts-sucking experience that everyone should try to avoid. Given the choice between two years of probation or a month in jail, consider a month in jail. Always ask the judge about a jail option over spending time on probation. You could also ask for an increased fine—though you may not have any money to give or you may have a moral objection to giving the system money.

Diversion Programs may also be an option. They are programs where the state agrees not to prosecute you if you do something like community service, pay a fine, or write an apology letter. Diversion can be a good deal, because it gets you back on the street—or in the woods, mountains, or wherever; however, you give up the ability to have a public trial to push for more publicity for your cause. You also normally give up the right to sue the government for civil rights abuses because of an unlawful arrest. Although, you can still sue them for beating you up or mistreating you.

## **TERRORISM LAWS, THE NEW TREASON**

Will they charge me with Terrorism? Maybe. The state and federal governments have passed a myriad of terrorism laws in recent years that are increasingly being used against anarchists, activists, and other political agitators.

If you get caught for a wide variety of kinds of sabotage to private property, a terrorism charge or punishment enhancement provision is possible. Recent Earth Liberation Front defendants have received a federal felony sentence enhancement for terrorism. The enhancement did not actually result in increased prison terms, but it has allowed the government to say that they are fighting “terrorism” and did result in unnecessarily harsh treatment in prison.

The government has also increasingly been using the Animal Enterprise Terrorism Act which codifies criminal acts that would hurt animal enterprise businesses as terrorism. Lefty lawyers are currently challenging that act as unconstitutional under the First Amendment, but you could still be charged under it. If so, look forward to being at the center of a national support campaign that includes beleaguered but hard-fighting civil libertarian lawyers and pictures of you on the Internet wearing a dorky sweater. You may also be sent to prison. That is all unlikely but possible. Sorry.

What about the PATRIOT Act? The PATRIOT Act is a shitty law that has a wide ranging impact. The two things that the PATRIOT Act did that are especially noteworthy for activists are as follows. If you lie to a federal official, such as an FBI agent or Forest Service officer, who is investigating a domestic terrorism crime, you can go to prison for 8 years instead of 5 years. The lesson is don't talk to them at all. Just walk away or invoke your right to remain silent. If you have any contact with international or foreign environmental groups, the government may be able to wiretap your phone by going to a secret court instead of a normal federal court.

### **CONSPIRACY TRIALS, GRAND JURIES, AND NON-COOPERATION**

In the last decade, state and federal cops have increasingly been using conspiracy charges and grand juries to target radical environmentalists, anarchists, and other revolutionaries. Conspiracy charges are convenient for police and federal agents in that they do not require the authorities to prove that any actual illegal activity took place, just that individuals have a shared intent. In that regard, they are an ideal weapon to wield against ideologically-based communities; they also lend themselves to government agents' efforts to entrap naïve activists. Conspiracy charges are intended to cause militants to back away from engaging in public organizing, losing connection with a broader social base and deepening the false dichotomy between passive community organizing and clandestine direct action.

Grand juries on the other hand are used primarily for information gathering and intimidation. Grand juries are investigatory hearings called to determine if someone should be indicted for a crime. Grand juries operate in secrecy. They are used to find information to implicate others in criminal activity and connect people to one another by mapping social networks—much like what facebook already does for the feds. Defense lawyers are not allowed to be present. If you are subpoenaed as witness to a grand jury, you will be questioned alone, and you should invoke your fifth amendment right to remain silent and refuse to testify. However, you can be put in jail for contempt of court for the duration of the grand jury—which can last up to 18 months.

The best defense against grand juries is to refuse to cooperate in any way from the very beginning. Legally, jail time for refusing to testify at a grand jury cannot be punitive. It is supposed to be a way to convince you to testify. If you make it clear that you absolutely will not testify, sometimes they will stop pursuing you for the grand jury, will excuse you from questioning or even release you from jail for the civil contempt charges—as happened to two Seattle grand jury resisters in early 2013 after five months in jail when their lawyer convinced a judge that “they would never end their confinement by testifying.”

We can protect ourselves from these tactics of state repression by practicing good security culture, keeping suspected informants out of our organizing groups, and always refusing to cooperate with the police. Most of the major ELF, ALF, and conspiracy cases of the last decade were only possible once people started to snitch on each other. Remember to keep all the secrets to yourself. But also remember that what the feds know, they already know. Share information about grand juries and federal agents approaching you or family members for questioning with your community transparently so that others can understand as much as possible about the strategies of the state and plan their defenses accordingly.

### **DON'T BE SCARED**

The author of this article is a lawyer and deals with people in prison everyday. The author thus believes that you should be given the legal truth—as scary as it may be. However, most Earth First!ers are never sent to prison or even jail. Indeed, most are never even arrested or caught breaking the law. Don't be scared. Hold your head high, gird your loins, and fight for the earth. If you don't do it, who will? It is the right choice and fun as hell. But you may go to prison.

*Text stolen from the Midnight Special Law Collective and a friendly, bio-regional, bio-centric, bi-curious, organic, free-range, used-to-be-vegan, gluten-free, Earth First! National Lawyers Guild affiliate. Then rearranged and put back together by someone else entirely.*



# >>> PRISONER SUPPORT

Prisons in this society are full to bursting with people who have been stolen from their families and communities, and the State is always looking to incarcerate as many people as possible. The prison system disproportionately targets black and brown men, people who are undocumented, and people who live at the edges of society because of economic coercion and political ideology. The prison system isolates and attempts to fragment communities resisting the policing forces of capital.

Prisoner support is integral to radical movements because political resistance breeds repression. Not only do people within the movement have an imperative to support people facing incarceration as a result of their beliefs and/or actions, but people who accept support from the movement while they are incarcerated have an imperative to respect the movement as a whole by not cooperating or testifying against co-defendants. Police and federal agents will threaten to treat you worse if you do not cooperate. Prepare for this by knowing your rights and the common tactics of the police to break solidarity. When we feel strong and connected it is much easier to stand up for ourselves, our rights and our ideologies, and to stay silent in the face of courts, interrogators and grand juries.

Ashanti Alston, ex-Black Liberation Army political prisoner once said, “The strength of a movement can be measured by the strength of its prisoner support.” Prisoner support is not only a tool necessary to the success and survival of our movement; it is also the antithesis of the oppression and exploitation that we seek to abolish. This understanding of our work as strengthening a movement for liberation differentiates us from the myriad of reform and charity-based groups.

The way a person is supported should be dictated by them and appropriate to the situation they are in. Be honest about your capacity and reliable in what you commit to do. Most prisoners will understand if things come up that are keeping you busy or preventing you from being on top of their support, but it is important that you let them know if this is the case. Many of the rules and regulations will depend on whether they are in a state facility or a federal facility. You can always look up the exact guidelines of the specific facility, but the following will refer to common practices.

## **CORRESPONDENCE**

Communication with people on the outside is often important for people both to process what they are going through and maintain healthy ties and connections to people on the outside. The main types of communication

with prisoners are mail, emails, and phone calls. Mail is generally the least expensive and therefore most accessible method of communication with people on the outside, and getting a letter at mail call is often the highpoint of the day for people in prison.

Writing for the first time to a stranger can seem awkward. Even if they don't know you, they may be interested in any news or information about your life. A card with some well wishes, a bit about who you are, and asking what you can do to help is often enough. You can write honestly if you anticipate that you will have the time to write regularly. With mail delays, writing consistently to a prisoner could entail about 1-2 letters per month. Some people are nervous to talk about their lives, or what they are up to, thinking that a new pen pal in prison won't be interested in their life or that this may depress people who are locked up, especially prisoners with long sentences. However, any news from the outside, whether it's about friends or not, is generally welcome. For people imprisoned from our movements and struggles, it's vital to keep them involved in the ongoing resistance—telling them about actions, sending them magazines they want, and discussing ideas and strategies with them. However, some people will want to keep a lower profile and not engage in politics until they get out. Feel free to ask if there are any particular subjects that a pen pal would like to talk about.

Don't expect prisoners to write back every time. Sometimes, the number of letters they can receive/write is restricted, or they just might not have the stamps or time to write back. If funds are the issue, you can either add money to the prisoner's commissary account—see information below—or some facilities will allow you to send in pre-stamped envelopes from the post office. Call the facility to verify that this is allowed before sending, though.

You should always put a return address on the envelope—as well as the letter in case the envelope is not given to the prisoner—not just so the prisoner can reply, but also because some prisons don't allow letters without a return address. Of course it doesn't have to be your address, and it is worth noting that, as illustrated by the case of Leslie James Pickering, authorities may be monitoring the mail of people on the outside as well as letters that go into prisons. Many federal facilities are now using a *Corrlinks* mailing label system. Some prisoners have a quota of people they can correspond with, while others can add as many people as they want to their correspondence list. If you receive a letter back that has an address label with your information on it rather than being handwritten, that facility is using *Corrlinks*.

All letters are opened and looked through, and some letters get copied, delayed or stopped. Don't write stuff that could endanger yourself, the

person you're writing to, or anyone else, and don't write any information that you don't want the authorities to have. Though this doesn't mean you should be overly paranoid. Numbering the pages may ensure that all of the pages make it to the prisoner—or at least they will know if one is missing. Most prisoners can receive photocopied or printed articles. Sometimes the facilities have a page limit, so check the mail regulations before sending a lengthy article.

### **EMAIL AND QUICK LETTERS**

The email system used by the federal prison system is called *Corrlinks*. Inmates must pay \$0.15 per minute for use of this system, and are permitted to print messages at a cost of \$0.15 per page. In many U.S. federal prisons, inmates' wages start at \$0.12 per hour. Sending a message to someone can cost up to \$0.30. This service is also available in some state prisons. The system does not allow inmates access to the internet, and all incoming and outgoing messages are monitored. Emails are limited to 13,000 characters, and no attachments are allowed. It is for this reason that many prisoners reserve email communication only for short messages that they would like to transmit faster than a letter. There are also some commercial services such as *Jpay* that may be used to send quick letters or messages that will arrive within a few days rather than up to a week via regular mail.

### **PHOTOGRAPHS, READING MATERIAL AND FOOD PACKAGES**

In addition to letters and printed or photocopied articles, many prisoners can receive photographs, magazine subscriptions, and books sent directly from distributors or publishers. For example, you can order books from online sources and have them shipped directly to the prisoner, or you can connect with a local books to prisoners group and use their system to send in books. Some radical publishers, such as the *Earth First! Journal* and *PM Press*, will offer free or discounted items to prisoners. Very few state prisons still allow food packages to be sent inside either monthly or a few times per year. These packages can be an important way to supplement the prison diet, but make sure you understand the restrictions before sending.

### **PHONE CALLS**

Phone calls from prison may also be costly, but are another way that prisoners could be in contact with you for quick and timely messages. In order to receive phone calls from someone in prison, you must send them your phone number so that they can add you to their approved contact list. Keep in mind that prisoners have restricted phone access and pay typically \$.25-1 per minute for phone time so check in about how brief they need the call to be and/or make sure they have enough phone call money.

## **COMMISSARY AND MONETARY SUPPORT**

Prison is a business based on slave labor. Prisoners typically get paid from 12 cents to a maximum of \$1.15 per hour for their work, but must pay for toiletries, food or vitamins to supplement the inadequate prison diet, and recreational items. Additionally, they may have costs from the legal process such as bail, legal fees, travel expenses, and court costs. Ask people you are supporting if there is a typical monthly or one-time donation amount they could use and try to find a way to fulfill that request.

Funds may be sent to a prisoner via money order sent to the Bureau of Prisons, though not directly to the prisoner. Directions on how to do this, as well as faster yet more costly payment methods are listed on the Bureau of Prisons website. Check with the person you are supporting before you send funds because those who have been ordered to pay restitution will have funds confiscated if sent to the BOP, and money must go through their support group.

## **PREPARING FOR VISITATION**

It should go without saying that visits can have a lasting positive impact on prisoners. It allows for a depth of communication that is often not possible through monitored or recorded correspondence. Some metropolitan areas, such as New York City, have bus services that go to the prisons in the area for a low fee. Be sure that the inmate knows you are coming, and be sure you have completed all necessary paperwork to be on the approved visitor's list. Often the prisoner will have to mail you the form for their facility and let you know when it is approved. For federal prisoners, you will have to state on the form how you met or are connected to them prior to their incarceration as well as if you are visiting any other federal prisoners.

Most federal prisons also have a point system which limits how many visits a prisoner can have per month. Make sure to clear the date you would like to come with the prisoner so that they can make sure they will have enough points to accommodate it and that it will not conflict with another visit they have planned. Especially for a first-time visit, plan on two days rather than just one. Read the facility's visitor information for the for regulations and what time you should arrive. Aim to arrive slightly early instead of slightly late. Even if you arrive early, there are often events that slow things down. Pay particular attention to the dress code in the visitor's guide, and bring an extra change of clothes in case something you are wearing ends up not being allowed.

## **ON VISITING DAY**

Call the prison one hour before you leave to verify that visitation has not been canceled for any reason. If there are things you know you want to

discuss, make a mental list because you will not be allowed to have pen or paper in the visiting room. There is usually a change machine before you enter the visiting room, since all food and beverages must be purchased from vending machines. Most facilities will allow you to bring about \$20 in coins into the visiting room in a clear plastic pouch or ziplock bag. The only other items you can bring into the facility are typically your state-issued ID and your car key, but there are lockers in case you need to store items during the visit. If you are taking an infant and need diapers and bottles, check ahead to see how this is handled at the prison.

Most visiting rooms have photo opportunities for a fee charged to the prisoner. Prisoners often like to have a photo or two from the visit, so try to make sure there are funds available for this. Avoid altercations with other visitors, guards, and prisoners. This could have an adverse impact on the person you are visiting, or you may be asked to leave or may be banned from visiting again.

### **POTENTIAL/COMMON HEALTH AND LEGAL ISSUES**

Medical care in prison is typically and strategically substandard. If a prisoner you are supporting is having difficulty accessing a proper diet, medical attention, or medications, a call or fax campaign to the assistant warden may be necessary as they typically manage the medical services. Prisoners can also fill out a form to grant someone on the outside access to their medical records. That way, a second opinion from a physician or health care practitioner can be solicited.

Occasionally someone will be punished for the support they are receiving. Especially in cases like this, it is a good idea for support people to maintain good relationships with a lawyer(s) working on the prisoner's case. They can help file motions to prevent retaliatory transfers, segregation, and other punishments.

### **SUPPORTING PRISONER ORGANIZING**

There are plenty of ways to get involved and help agitate for prisoner rights, release, and for prison abolition. Frequently prisoners will be working their own organizing inside—often for improved conditions or in response to brutality from prison guards. If someone that you know is involved on the inside, write to them to let them know that you are open to doing what you can from the outside. If you hear about a protest happening where you don't already know someone, check for names of prisoners who are quoted in news stories or ask local prison abolition groups for contacts to write to offer solidarity. Be ready to plan things like phone in days, demonstrations outside the prison, press conferences, and meetings with prison officials.

There are also occasional days each year that a prisoner, or their support crew, calls for solidarity actions. One of the best known is June 11—which started as a day to support Jeff “Free” Luers in getting a reduction for his outrageous 22 year sentence. Now that Free has been released, June 11 is a day in solidarity with Marius Mason and Eric McDavid—the two anarchist, eco-liberationists with the longest movement related prison sentences of 22 and 20 years, respectively. These days of action usually involve planning awareness events, protests at prison facilities and offices, general actions against the Prison Industrial Complex, calling the prison the person is incarcerated in, and fundraising.

### **POST-RELEASE SUPPORT**

It is also important to recognize that support should not end the day someone is released. Especially if convicted of a felony, people may have issues securing housing and/or employment. There may also be additional needs around accessing affordable healthcare that they were denied access to while in prison. It is a good idea to plan to give people a supply of funds upon their release to help them transition. This amount could be a few thousand dollars or roughly a few hundred for every year they were in prison. Everyone is different, and their desires and needs will be too—both while incarcerated and after they get out. Enjoy making new friends or staying connected to old ones, even if the state has kidnapped them.



Korean unionist attacks a police line in protest of neo-liberalism.



# »»» POLICE INTIMIDATION AND TORTURE TACTICS

Not every lock down ends with police cutting the activists out of their devices. Often police will choose intimidation or straightforward brutality to coerce activists into unlocking, rather than go through the effort of cutting them out of their locks. You never know what approach the police will take, but it pays to be mentally and physically prepared for any scenario so that you can better deal with the situation. Cops have used everything from hollow threats to Tasers to get activists to unlock. What follows is not a guide to treating the health effects of police brutality or chemical weapons. That is beyond the scope of this manual. This section is meant to help prepare you for what the police might do and minimize the effects of their tactics.

As brutal as police may be, most departments are, to one degree or another, conscientious of their public image. Your best protection against police violence is to conduct your actions in very public places with lots of supporters on hand. Also having still cameras, video cameras, and mainstream media present can help keep the cops in line. They are less likely to brutalize activists if they know their actions will be on the evening news.





## **INTIMIDATION AND LIES (I.E. BEING COPS)**

Sometimes people end up unlocking or climbing down from a blockade structure on their own. This is not always a bad choice—if the goals have been met for the blockade, or if the climber/blockader has reached their own capacity, coming down is a good choice. Unfortunately, the cops are also good at coercing people into climbing down prematurely.

When taking the mean route, cops will threaten things like extra charges—often felony charges—for not coming down. They will lie about an emergency beyond the blockade and threaten fines or heavier charges for keeping emergency vehicles from responding to it. Be aware of how police have reacted to similar situations in the area. The police forces in the U.S, where activists have varying degrees of privilege, have not commonly injured blockaders by cutting ropes and toppling structures. Cops have been known to do dangerous things like vigorously shake poles and ropes and convincingly threaten to just knock the whole thing down—or have allowed workers to do these things. But from time to time cops have followed through on those threats and injured activists by haphazardly dismantling blockades. Occasionally cops get real personal and make up stories about parents and loved ones calling the cop shop to ask you to come down, or say that support people who have been pushed away are now asking for the blockade to end.

If they decide to take the nice route, cops have been known to promise no charges, or lesser charges for coming down early. One or more officers may pretend to be friendly and “on your side,” then use that fake relationship to convincingly talk about the point being made already and the ineffectiveness of staying up any longer. It can be harder to remember with the nice cops, but cops lie—all the time. That is their job, and they are good at it. Keep in mind that if they were on the right side, they would have quit their job and would not be spending time convincing you to climb down. It’s important to be just as mentally prepared to deal with the cops acting friendly as it is to be ready for threats and intimidation. Never responding to police, and not engaging in casual conversation with them, is a great baseline tactic for ending their conversation.

The police may threaten to use chemical weapons such as pepper spray or Tasers. They may be bluffing; they may not be. It is also becoming increasingly common for police to bring their SWAT teams, armed to the teeth, out in a show of force in an attempt to intimidate. They may even train their assault rifles on you in an attempt to scare you into unlocking.

## **PAIN COMPLIANCE HOLDS**

There are a number of pressure points on your body that are extremely painful when force is applied. Most cops are trained in inflicting pain in at least a few of these points. Typically this is done by pressing a finger or baton into the pressure point. Some of these points include areas around your jaw and ears, your neck, and your hands and fingers.

If you find yourself the unlucky recipient of such treatments, there are a few things you can do. First, relax your body as much as possible and breathe deeply. It sounds simple, but focusing on deep breathing can help you handle the pain. Also, the cops may not hit the pressure point right off the bat. So if you scream in pain when they are not actually hurting you, they may think they found the point when they haven't. Conversely, when they hit the point, be as quiet as possible, so they think they have missed it. Be extremely cautious using this tactic if the cops are using joint locks or pressure that could result in broken or dislocated limbs.



## **PEPPER SPRAY**

Police have been known to use pepper spray on activists in order to coerce them into unlocking. Sometimes they will just spray that shit in your face. They have also put it on q-tip shaped applicators and applied it directly to activists' eyes. Either way you are in for some excruciating pain. Pepper spray can also irritate your lungs and cause uncontrollable coughing and gagging.

Pepper spray is rarely used, but it is good to be prepared. If you think you might be in a situation where pepper spray could be used, do not wear contact lenses. Pepper spray can get trapped under the lenses, causing damage to your eyes. Don't wear oil based lotions or sunscreen. Pepper spray adheres to oil based products and will be harder to get off your skin if you are wearing them. If the police cannot physically access you in your locked down position, goggles and a painter's respirator or a gas mask with plastic lenses can protect you, but if the police are able to remove it, they will do so and proceed to pepper spray you anyway. As

with pain compliance holds, remaining calm and grounded can go a long way in helping you work through the pain and stay locked down.

A 50/50 mixture of water and an unflavored liquid antacid can provide some relief from pepper spray when applied to the affected area. Do not use flavored antacids; the flavorings may be irritating to your eyes.

It is important to note that several forest activists won a federal lawsuit against the Humboldt County Sheriff's Department in 2005 for the officer's use of pepper spray on activists who were locked down. The use of pepper spray on the activists was found to be an unconstitutional use of excessive force by the police. This won't stop the police from using it on you, but could help you out in the courtroom.

## **TEAR GAS**

You are only likely to encounter tear gas in mass protest situations where police have lost control and are trying to clear large groups of people out of an area. Rarely will it be used in smaller, affinity group sized lock down situations. Tear gas is released from a canister that is either thrown by hand or shot from a special gun. It will form a large cloud that affects anyone in it by irritating the eyes, skin, and lungs. It can cause painful burning sensations, coughing, and gagging—and yes, you will cry. Police are only likely to use tear gas in situations where the crowd is too unruly for them to interact with at close distances. Most lock down situations do not take place during riots, but riots and lock downs do occasionally cross paths.

As with pepper spray, don't wear oil based lotions or sunscreen because tear gas adheres to them. Gas masks or goggles and a painter's respirator are effective at preventing the effects of tear gas. Again, don't wear gas masks with glass lenses that can shatter and hurt you. A bandana soaked in diluted vinegar or lemon juice wrapped around your face—or simply chewing on a lemon—can help mitigate the effects of tear gas as well. If there are support people on hand, they can kick or throw the tear gas canisters away from those locked down. However only do this with heavy leather gloves because tear gas canisters are very hot.

## **TASERS**

Tasers are the most recent innovation in sadistic police tactics used on activists who are locked down. They are basically stun guns with the ability to shoot two small dart-like electrodes, which stay connected to the main unit by conductive wire. The cops can send a painful electric shock to your body from up to 35 feet away. Tasers primarily function by creating neuromuscular incapacitation as the device interrupts the brain's ability to control the muscles in the body. This creates an

immediate and unavoidable incapacitation that cannot be overcome. It is also excruciatingly painful, described by one unlucky Earth First!er as “feeling like a thousand knives being stabbed into my back.”

While plenty of activists have been able to hold out against the painful effects of tear gas and pepper spray, few have stayed locked down after being tased. There is nothing you can really do to mitigate the effects of tasers other than attempt to stay out of the 35 foot range, which is not practical for many lock down situations. Tasers can also be lethal. Numerous people have died from being tased, especially those with heart conditions.

The good news is that police have only been known to use Tasers on people locked down three or four times out of the thousands of civil disobedience actions that have taken place since cops started carrying them. While they are effective in coercing one to unlock, it also looks really bad for the police to be using electric shocks on activists who are already immobile. Your best defense is to have lots of support on the scene with both video and still cameras to document and hope that the police are more concerned about their public image than getting you to unlock.

### **DOGS AND HORSES**

The police will sometimes bring out canine units to help break up a blockade. This is usually purely for intimidation's sake, which can be quite effective, considering those German Shepherds are trained to bite the shit out of people. To our knowledge, the police in the US have never let dogs actually attack people who were locked down, though many have potent memories of their use in the civil rights movement in the South. Horses are sometimes used for crowd control situations too. This is also more likely in urban mass action situations. They are used to disperse crowds and break through body blockades with great effect. There is little you can do to stop a horse from plowing into a crowd and there is a high probability of getting severely injured by those hooves. It is important to note that you can be charged with assaulting an officer for striking or even touching police animals.

### **NOISE AND LIGHTS**

In situations where the police haven't been able to figure out how to evict blockaders, workers and cops have been known to subject the blockader to loud noises and bright lights 24/7 in order to deprive them of sleep and generally make life too hellish to maintain the blockade. Ear plugs or sound blocking ear muffs and something to cover your eyes can help to mitigate this. Helicopters have also been used to hover dangerously close to trees to try to scare people down. Hang tight!

## DON'T SHIT YOUR PANTS

All this talk of Tasers, pepper spray, and police dogs may have you thinking twice about doing a lock down. While the police do resort to these tactics from time to time, the vast majority of civil disobedience actions do not see this type of brutality. Nonetheless it is important to know what situations may arise so that you can be ready for whatever the cops have in store for you. Many people have successfully maintained their lock downs despite unbelievable violence from the police. However, if you ever feel that your safety is in jeopardy, there is no shame in unlocking. Our movement doesn't need martyrs.



Carnival Against Capitalism takes to the streets of London against the G8, June 18, 1999

# >>> YO! WHAT'S WITH THE COPS? UNDERSTANDING POLICE TACTICS

Just as Earth First! style lock down tactics became an element incorporated into mass mobilizations during the anti-globalization movement; mass mobilizations, unpermitted marches, and urban uprisings offer a plethora of skills and tactics to pass on to the EF! movement. This is important as EF! actions continue to draw increasingly large numbers of participants, as well as a heavy police response. While it is sometimes strategic to have groups of people engage in an action, then get out of the area, here are some things to consider when you're sticking around.

In discussing mass actions, we broadly describe actions ranging from 50 people mobbing a rural work site to 50,000 people storming the streets. Although these actions themselves are quite different, one unifying factor is that the protesters outnumber the cops. When this is not the case, your options will be much more limited, and you should consider whether to deploy your action or use your well-thought out exit strategy. Were your goals of shutting down a corporate office achieved because of the massive police response itself?

When preparing for mass actions, hopefully you have a solid affinity group, but at bare minimum have an action buddy. Make sure everyone in your group is on the same page in regard to the tactics you want to use and when to call it quits. When planning with your group, take into account how your actions may affect bystanders or other protestors. Ask yourselves questions like: Will our actions be putting people at a greater risk of deportation? Will people be bringing their children to the action? Does the campaign want to have itself associated with property destruction?

See **Anatomy of an Action** for more about forming affinity groups, roles, and general action planning.

## **POLICE TACTICS**

Police crowd control is always evolving in strategy and technology, and police are increasingly sharing communication and training protocols. Despite this, police departments will have varying levels of experience with crowd control and protests, as well as different policies dictating their response. So getting a sense of what the precedents have been for police responses to similar situations will help you to understand their

behavior. There is an abundance of police training material that has them expecting dangerous eco-terrorists using Molotov cocktails, flying poo, and baseball bats. If that is what they are expecting, they could begin acting out of thinly veiled fear.

Police may rely on an image of discipline and coordination among their ranks to instill cooperation among the masses. Some cops may wear no protective gear and try to negotiate with the crowd, hoping to keep things calm by not escalating the scenario with their response. Others will use chemical weapons, like pepper spray or tear gas, or will immediately don full riot gear in a show of force and intimidation, attempting to control the scenario from the get go. Police may use horses and dogs to intimidate protestors. Some may arrest whole city blocks of people, others may use snatch squads to arrest individuals they deem to be leaders or troublemakers.

Before arresting large groups of people, police may give a dispersal order. This can be taken as a sign that the dynamics between protestors and police may be about to shift. Be on the lookout for arrest teams—often carrying bunches of plastic riot cuffs or putting their leather gloves on—preparing to move in and large prisoner transport vehicles in the area. Also be on the lookout for other changing police formations, like a small group advancing toward the crowd to extract one person or large lines forming to create a perimeter. It's important to remember that police are supposed to follow a chain of command that can take time to respond to new situations. Being somewhat unpredictable can be advantageous. Keep things moving. Retreat, advance, repeat.

## **SURVEILLANCE**

Be aware that you may be followed by cops or surveillance agents on your way to, during, or while leaving an action. Depending on the situation, this may not be a big deal or it could really jeopardize the safety of your affinity group and others. Basic techniques for eluding someone who's following you include splitting into two groups, doubling back, and entering a crowded area. Try to gauge the level of risk in the situation and act accordingly. If you think you are being followed, don't lead your tail back to the place you are staying, organizing out of, or meeting other friends; if it is safe enough for you, stop somewhere public until your tail loses interest.

## **POLICE LIAISON**

When on public property, the cops may respect the charade of entitlement to free assembly. This does not mean you are immune



to arrest. A good police liaison has been an essential role in keeping relations with the police safe and smooth. It is the liaison's job to keep the channels of communication open, relaying information between police and protestors, and to slow down the speed of police response by insisting on the liaison's inability to make decisions for the group, only to convey information that must be discussed and consensed upon.

The police liaison should be focusing on the police for the entirety of the action, letting the crowd, media liaisons, and worker liaisons handle conflicts with people other than the police. This dialogue with the police can be important, however beware of any deals they may offer. Time and time again police have offered agreements to not arrest people if they disperse or unlock from something and proven themselves to be trained liars.



### **SAFETY IN NUMBERS**

While large groups can be a great distraction for small teams to complete their own missions—such as dropping a banner or removing the air from nearby truck tires—they can also offer safety to those within the groups. When police advance, it's not always time to scatter into the wind, leaving unlucky folks behind to be snatched up by the po-po. That doesn't mean there is never a time to run, but by staying tight or linking arms, you can still slowly retreat or hold your ground.

Police seem to have a hard time understanding a horizontal organizing structure and are convinced that there is always a leader or two to blame.

These people often are the target of snatch squads. If you see a couple cops huddled—possibly reviewing a camera or pointing at someone, it's possible that person may be the next arrest target. Targeting can be subtle and hard to notice, but be aware that it may be happening. Video footage could also be used for arrests after an action. If someone has been targeted, one option is to circle around them, allowing them to change into spare clothes, and work on an exit strategy for them.



## **BANNERS**

Beyond providing clear messaging, banners can provide safety. The visual barrier that a banner creates can sometimes be enough to encourage police to keep their distance, and banners can provide a clear visual to follow, helping people move collectively into or out of danger.

Hard banners, reinforced or framed by something like wood or made from inflexible material, like plywood or insulation board, add rigidity and a place to hold onto. Be aware that in a scuffle with the police, banners made from flimsy reinforcement, like bamboo or PVC held together with mere zip ties, can break apart and have been used by the police to beat protestors. There is nothing more humiliating than to be beaten with the detritus of your own banner. Hard banners can also be used offensively to move through lines of police. One method involves two banners or a hinged banner forming a V, with the tip of the V being used as a wedge to disrupt and open police lines.

## **DE-ARRESTING**

Just because the cops do get their hands on one of your buddies, doesn't always mean that they're going to jail. While running the risk of further escalating what is most likely a tense moment, successful de-arrests have happened in a variety of situations. Take into consideration the

general level of chaos around you: the more anonymous/less visible you are to the police and the more likely others are to assist you in the struggle, the more likely everyone is to get away free.

Talk to your action buddy or affinity group ahead of time about this so you know what response to expect from your team. A rowdy crowd or a nearby posse of trusted friends, will often create a safer environment for successful de-arrests. Also consider how your actions will be read, both in the moment and for potential legal repercussions, if someone does get arrested. The line between resisting arrest and assault on an officer is legally grey, but if you can get someone out of the clutches of the police simply by grabbing onto the arm the police are reaching for rather than elbowing a cop in the face, execute the less risky move. Whatever you do, act decisively. Once you make a move, commit to it, follow through, and then get out of the danger zone.

If you want to support a de-arrest situation, but don't want to be directly involved in the conflict, you can passively get in the way of the police advances, get in close, surround the police, generally increase the uncertainty. If you aren't that close by, create somewhere safe to escape to, like a friendly crowd on the sidewalk where folks can work their disguise, and then their exit.

## **EXIT STRATEGY**

Knowing when to get the hell out is a super important and often overlooked skill. Lack of a good exit strategy has transformed many an action from having one planned arrest to a legal team scrambling to deal with ten people locked up with exorbitant bails. Think about having preset scenarios that dictate when to leave and a pre-planned signal to coordinate leaving collectively—air horns or other loud noise makers work well for this. Also, be familiar with the area and what your transportation options are. Having an agreed upon meet-up spot to reconvene if your group gets split up can be helpful for getting back together after a chaotic situation arises. Sometimes the plan really goes to shit, and you can't casually walk away or blend in with a crowd. Be prepared to run.



# 4

## GROUND BLOCKADES

*Native youth shut down the Snowbowl ski resort in Arizona to defend sacred sites from development, 2011*

# >>> BODY BLOCKADES

- + Quick and easy
- + Costs nothing
- + No materials required
- Easy to dismantle
- Activists exposed to police and workers



A body blockade is any type of blockade that uses only human bodies, with no additional hardware such as chains or lockboxes. They are simple, extremely quick to set up, and very versatile. Body blockades are useful in a variety of scenarios, from a single person laying down in front of a vehicle on an isolated mine site to thousands of people linking arms to shut down a financial district during a mass action. The downside to body blockades is that they usually are not very long lasting. As long as the police have enough muscle on hand they can pretty easily dismantle your blockade if that is what they want to do.

There are endless configurations for how you can form a body blockade. The key is finding a way to link together that makes it difficult for the police to pull you apart and remove you from the scene.

## LINKING ARMS

This is the simplest way of linking yourself to another person. Form a line of people, arm to arm, facing the same direction. Hook your arms through the arms of the person next to you and bend your forearm back towards your stomach. To make this even stronger, clasp your hands together in front of your chest. This will make it more difficult for the police to wrench an arm free and pull you loose.



Police may also try prying a finger and pulling it in a way it's not meant to go in order to induce pain and make you loosen your grip. You can reduce the chances of this by clasping your hands together in a special way. While your arms are linked, face your hands palm to palm in front of your chest. Clasp your four fingers (pinky through pointer) tightly together, and tuck your thumbs under your fingers. The cops will have to poke and pry a lot harder in order to get a finger to yank on now.

Once you are linked up, you have the choice to remain standing or sit down. If you remain standing, your blockade is generally less stable, and it is far easier for the police to push you out of the way and pull individuals out of the blockade. But you are also more mobile and can respond quickly to situations as they arise. Sometimes when you are blocking a vehicle while standing, the driver may slowly drive into your blockade, counting on you to walk back as the vehicle progresses, and soon enough they will have broken through. If you are sitting with arms linked they are less likely to do this, but you are also at greater risk of being run over if the driver is especially reckless.

While sit down blockades can make you less able to adapt to dangers as they arise, they are more difficult to break apart. The police will have to lift or drag you out of the way, which can take far more effort and officers to break up the blockade than if you are standing.

### **SITTING WITH ARMS UNDER LEGS**

Given that your hands are a weak link in a body blockade, you can strengthen it by tucking your hands under your legs while your arms are linked together and you are all sitting down. It can be a little awkward, and can be a bit tight fitting everyone together, but your hands will be much less accessible to the prying hands of police. You can either sit on your hands or clasp them together.





## TOBOGGAN AKA CATERPILLAR

Sit down in a line with everyone facing forward so that you are facing the back of the person in front of you. Wrap your legs around the waist of the person in front of you and your arms around their stomach or chest. Make sure your arms are going underneath the person in front of you's arms. Repeat this on down the line so that you form a human caterpillar. Having both your arms and legs wrapped around another person makes it harder to pull apart this blockade, but it is also not the most comfortable position to be in for long periods of time.

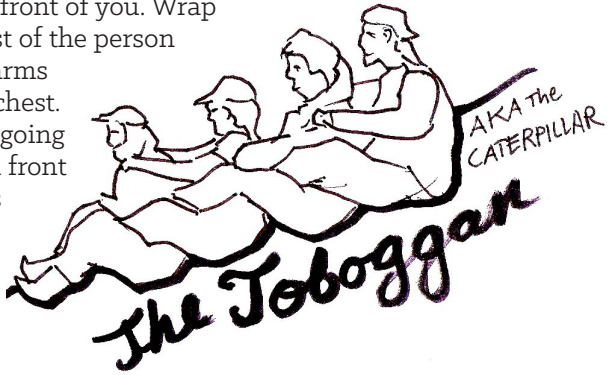

## CIRCLING UP

You can strengthen your blockade by arranging yourselves in a circle rather than a straight line. When you are in a line the people on the ends are often the first to be targeted, and the cops will start picking people off from the end, one by one. If you are circled up, there will be no loose ends for the cops to target. Another advantage of a circle is that you will have people facing in every direction so your group will have a much better awareness of what's going on around you. You can choose to have everyone facing inward or outward. It's easier to communicate with each other if you are facing inward.

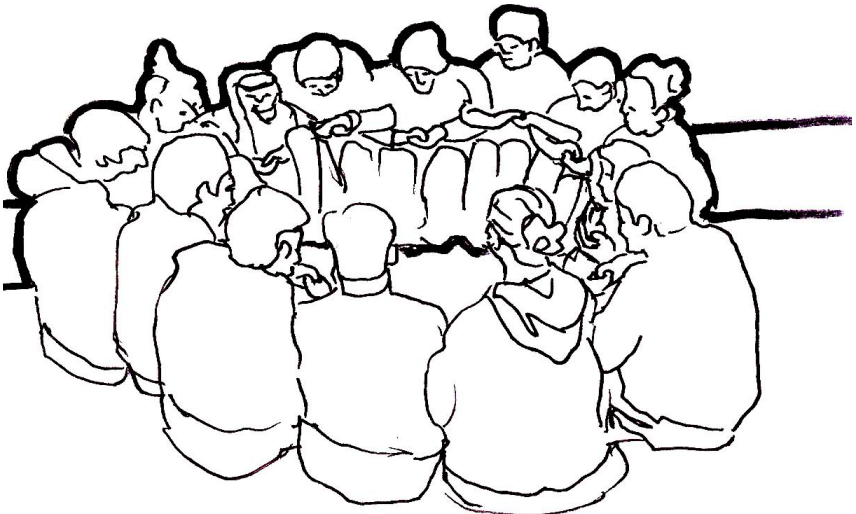



If you have a lot of people available for a blockade, you can do concentric circles of people around each other; a circle of four people, is surround by a circle of eight which is surrounded by a circle of sixteen, and on and on. It can take quite a while, and a lot of energy for the cops to get all the way into that inner circle. One of the downsides of being in a circle is that it will take almost twice as many people to block a given road as it would if you were stretched out in a straight line.

### **NOTHING TO IT BUT TO DO IT**

These are just a few of the more common ways of creating body blockades. There are endless ways you can configure your affinity group into a difficult to remove mass of people. Before doing a body blockade, get your affinity group together and practice some of the different ways of linking together. Try maintaining the position you're going to be in for 15 minutes to see if you need to adjust anything. Have a few friends be cops and try to pull you apart. This will give you a sense of what works and what doesn't, as well as mentally preparing you for being manhandled by the police.

Body blockades are useful in many scenarios. Perhaps you are engaged in a long term campaign which you want to gradually escalate. You could start off with a body blockade or two in order to build some awareness before moving on to harder to remove lock downs; which you might want to save for later. In mass demonstration situations you can often create effective mobile blockades without getting arrested. Your affinity group can block an entrance or intersection until it looks like the police are going to make arrests, and then simply leave and blend in to the crowd and move on to another intersection or entrance. Sometimes if there are enough people engaging in a body blockade the police won't even try to dismantle it, because they don't have enough officers on hand or are afraid of the situation descending into chaos if they try to arrest that many people. Other times they may choose to club, pepper spray, or tear gas the crowd in order to disperse it rather than make arrests.

A common use of body blockade tactics is to reinforce a lock down. Have a line of people link arms in front of the activists who are locked down. This can help ensure the safety of those locked down by discouraging workers from trying to drive into them or otherwise mess with them. It also gives the cops one more group of people that they have to deal with, hopefully prolonging the time before they get to removing those that are locked down. The body blockaders can choose to stay there until arrested, or simply dissolve the blockade before being arrested. Either way they will likely buy some extra time for the folks locked down.

## >>>U-LOCKS

- + Cheap
- + No assembly required
- + Quick to deploy
- + Easy to conceal
- Easy to cut through
- Risks severe neck injury
- Exposes blockader to cops/opponents



U-locks are perhaps the most popular and versatile lock down devices known to activists and law enforcement agencies alike. They were the first real devices, besides chains, that activists used to blockade, and they have been used on countless urban and backwoods blockades. Anti-nuke activists can be credited for introducing U-locks to direct action. Earth First!ers then borrowed the technique in 1986 and successfully shut down the headquarters of Willamette Industries in Portland, OR the day after the company began logging in the Millennium Grove old growth forest.

Some say that U-locks are boring and out of date because they are used so often and law enforcement generally know how to deal with them. But the fact remains that U-locks are easy to procure and you can't beat the ease of deployment even when there's a whole herd of pigs on the scene.

U-locks are available from bike stores, most hardware stores, and certain big box stores that we will refrain from endorsing in this publication. They range in price from \$10-\$70 and you tend to get what you pay for. The cops can cut through cheap U-locks in a matter of seconds with a large pair of bolt cutters, whereas they will have to bust out a grinder or the jaws of life in order to cut through the better locks. Cheaper locks tend to be made of hollow steel piping; the pricier ones will be solid steel. So don't be a cheapskate if you want your lock down to last for a while.

U-locks come in several sizes and can be concealed very neatly under shirts, on waistlines, around necks, or in discreet bags. They are attachable at the neck to vehicles at various points including the steering wheel, door window frames and wheel axles. Other objects to lock to include; door handles (not knobs), railway tracks, storefront

signs, construction equipment, office furniture, podiums, railings, gates, friends. You get the idea. **MAKE SURE WHATEVER YOU LOCK TO IS NOT EASILY DISASSEMBLED.** It is quite the bummer when you go to the trouble of locking yourself to a machine and all the cops have to do is unscrew the railing you are attached to!

A single U-lock is usually sufficient for a lock down. However, when you need more room to maneuver, use two locks. Just loop another lock into the one around your neck, creating a U-lock necklace. This will give you the extra length you will need to attach to those hard to reach objects like wheel axles. When you go for it, already have one lock secured around your neck and the other one unlocked in your hand. Get into position and loop the unlocked lock around your target, then intersect it with the lock around your neck. Lock it and deal with your key quickly.

A tight fitting U-lock can also be locked around your ankles with your legs straddling an anchor point such as a guardrail or fence post. You can also lock your ankle to another person's ankle to create a multi-person lock down. Make absolutely sure that the lock you are using fits tightly enough that it cannot be slipped over your bare feet.

While you may think you are the ultimate lock down warrior and won't ever unlock until the system has collapsed, it is still a really good idea to have a key nearby in the event that you decide you want to unlock.

You never know what might happen. This means hiding the key on your body where you don't think the police would likely feel it in a pat down, hide it in a spot nearby that you won't forget where it is, or have a support person hold onto it, preferably hidden on their body in case of a pat down.

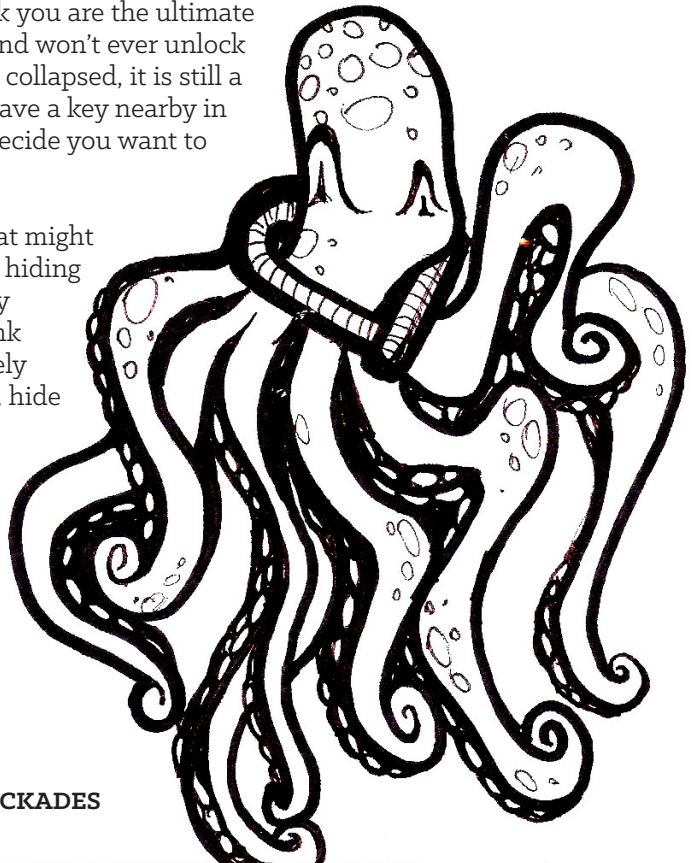

## TEAMING UP

Two or more people, six-to-eight works well, can lock neck to neck with multiple U-locks. Sit-in style blockades and office occupations, once easily broken up by the cops, can now be sealed in steel. Intersect U-locks around people's necks and lock them together in a circle, with your backs to each other and legs facing out, forming a Human Octopus. The power of the Octopus is the tight fit of the locks around everyone's necks, making it extremely dangerous to cut people out.

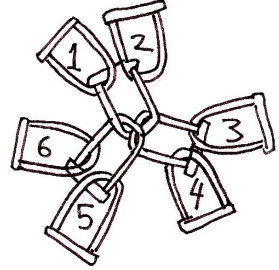

People can also lock neck-to-neck in a line. This is way less complicated but easier to dismantle because the locks are exposed. If your lock down only consists of people locked to each other and is not anchored to an immobile object be aware of what you are sitting on. A Human Octopus occupation of a circus performance in Oregon came to an untimely end when activists deployed on top of a large moveable floor tarp. The police simply dragged the tarp out of the way with the activists on it!

## REMOVAL

Diamond grinders or the pneumatic jaws of life will have to be brought in to cut through high quality locks. It can be a rather terrifying experience to have a grinder blade spinning at 10,000 rpm's and spitting sparks only inches from your neck as they cut through your lock. Often, law enforcement will clear supporters away from the scene leaving the locked down activist even more isolated and vulnerable.

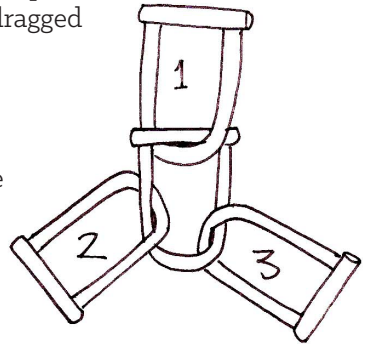

If you are only locked to another person, or even multiple people, the police may decide to carry all of you out of the way at the same time. This is pretty dangerous considering that your necks are attached to each other. Once you are out of the way they may just wait until you unlock and then arrest you.

That being said, many police departments have never dealt with activists locking their necks to things and it may take hours before they figure out what to do. Or they might just try and wait you out—which is why it is a good idea to keep that key on hand.

**WARNING** Using U-locks around the neck is extremely dangerous!!! Someone can easily sustain a severe neck injury or have their airway completely restricted if the U-lock is manipulated with force! This is especially true if the lock down person has medical conditions, is suspended unsafely from the ground or is attached to a potentially moving object, like a door, gate, or vehicle. Remember, it is only safe to lock down to equipment/vehicles when they are not running and when there are enough people to watch and control operators.



# »»» COBRA LINK MOTORCYCLE LOCKS

- + No assembly required
- + Quick to deploy
- + Easy to conceal
- + Difficult to cut through
- Expensive
- Exposes blockader to cops/opponents

Cobra Links and bike lock steel cables lend you the strength of quality U-locks but the flexibility of a chain. A Cobra Link is a hardened steel cable encased by overlapping hardened steel plates. They are actually stronger than U-locks and have been known to break the blades on the jaws of life multiple times before being cut through. Bike lock cables are simply woven steel cables that are more difficult to cut through than chain.

Both of these devices expand lock down possibilities for those hard to fit places and increase personal comfort. Multiple links and cables can be intersected to lock down several people. Multiple cables can also be linked to stretch across a road, and locked on both ends to light poles or fence posts to shut down an intersection or entrance, and nobody needs to get arrested—if you are quick. For safety reasons it is important to attach bright flagging or better yet a banner to the cables so that cars are aware of its presence. Cables are also great for locking machines and vehicles together rendering them immobile without leaving someone there to be arrested.

Like U-locks these devices come in various lengths and sizes and are easily concealed under a shirt or in a bag. What's better is that they tend to confuse law enforcement officers who are less likely to have dealt with them before. As with U-locks, always keep the key nearby in the event you decide you want to unlock.

The catch is Cobra Links are extremely expensive, ranging in price from \$170-\$280. Bike cables are more affordable, ranging from \$20-\$100. But the cables need to be thick to be effective. And of course keep your eyes out for used ones.

## **REMOVAL**

Unless you use a crappy padlock with your cables, police won't be able to cut through these with bolt cutters. They will either coerce you or cut you out with a diamond grinder or the jaws of life. Or if you planned poorly, they may find where you hid your key and just unlock you.



# >>> CHAIN AND CABLE

- + Common place materials, easy to acquire
- + Quick to deploy
- + Easy to conceal
- Can be easy to cut through depending on chain size
- Exposes blockader to cops/opponents
- Heavy



Case-hardened or cobalt chains were used as the first lock down devices and have largely been replaced with stronger stuff. The media understands chain blockades better than the other devices activists use. We've all seen headlines like, "Activists Chain Themselves to Bulldozers." The fact is that chains are not as strong as U-locks or steel cables. But if the chain links are big enough, they can even hinder big bolt cutters. Chains do work for locking large groups of people together, waist to waist, in blockades but they are very heavy and hard to conceal. Buying chain brand new is also expensive. Try picking it up at the dump, scrap yards, construction sites, or a dock.

Heavy duty logging type cable or 1" wire rope can also make custom lock down devices. Cables are much stronger than chains and are extremely difficult to cut without the proper tools. Figure out exactly what length of cable you'll need and acquire it at a logging/ship supply store. Craft a tight story about needing it to move a junker car or tie off your boat. Better yet, just tell them your boss told you to get it, for what you don't know. Have them cut it to length and "swedge" a loop on each end of it. You'll lock the cable shut with a U-lock or disc lock.

The padlock you will use to close the chain or cable with is often the weakest link in your blockade system. However, case-hardened circular disc locks are available for \$20 and are not easily cut through. Padlocks will work if you are willing to go to the trouble of protecting them with small lock tubes. Make the lock tube from a short length of steel pipe or box tube that is sealed at one end. Cut two narrow holes in the top for the chain to slip through and weld a steel rod or pin inside the pipe. Place it perpendicular to the pipe near the top for the lock to clip around.

## REMOVAL

All but the biggest chain can be cut with bolt cutters. Cable is more difficult to cut and will require specialized wire cutters, diamond grinder, or jaws of life to cut through. If you use a crappy lock, the police will cut through it rather than bother with your cable.



# >>> LOCKBOXES

- + **Difficult to dismantle**
- + **Quick to deploy**
- + **Cheap**
- **Heavy**
- **Not easily concealed**
- **Requires specialized tools (welding)**
- **Exposes activist to police and opponents**

Lockboxes are heavy duty lock down devices with the potential to make your blockade last a lot longer. They are special sized steel pipes designed for activists to insert their arms and connect their wrists to a hidden metal pin attached to the inside of the pipe. The pin is what the lock down person clips their wrists to with chain bracelets, known as jewelry. It prevents the cops from pulling the person's arms out far enough to cut their chain bracelets off with bolt cutters.

Lockboxes were innovated to overcome the ease of which law enforcement had in cutting through chains and U-locks. Greenpeace designed the first lockboxes to blockade chemical shipments in the 80's. Since then activists have successfully used lockboxes to blockade logging roads, shut down power plants, occupy offices, and disrupt work on mine sites among other wholesome activities. There are several different types of lockboxes. These are the straight box, the 90 degree Black Bear, the PVC box, and the hybrid concrete super box.

Weighing in at approximately 20-25 lbs., steel lockboxes are not light! They are big and heavy. Unless you are in a crowd, they are difficult to conceal; although not impossible. Backpacks, shoulder bags, specialty hand bags, even baby buggies have been used by activists to smuggle them into convention centers, corporate offices and government buildings. Nothing seems to work better to lock down to vehicles, heavy equipment, or metal gates with than lockboxes. But, because of their weight and bulkiness, be extremely careful moving with them, especially around cops who may misconstrue them as weapons. A diamond saw is required to cut them, and it will take much longer to do so than a U-lock. It's also one big hassle and they may choose to torture you instead!

A 2008 blockade of the Cliffside Coal Plant construction site in NC came to an untimely end when police decided to taser the four people locked to machinery rather than attempt to cut them out. Never underestimate the ability of the police to engage in cruel and sadistic acts.

Cheap, used materials for lockboxes are easily found at salvage/wrecking/recycling yards. Check construction sites too. If you do not have access to a welding torch, you can have the welding done through any machine shop as an “art project.” Do not use real names. Pay only in cash. If your group sees the ongoing need for lockboxes or feels it could supply them to others in your area, it is best to invest in a modest arc welder and/or an acetylene cutting torch.

## **REMOVAL**

The weakest points on the lockbox are the center pin and your bracelets. If the police are able to locate where your center pin is, they have been known to drill into from the outside to break it loose. That is why it’s a good idea to locate it slightly off center and hide any obvious signs of its location from the outside. If your arms do not fit snugly in your lockbox, or your bracelet is too long, the cops may be able to access it and cut through it. This is why you should never use rope or webbing for your bracelets.

Diamond grinders seem to be the tool of choice for cutting activists out of lockboxes. This can be a pretty frightening experience. You will be immobile while a high speed grinder cuts metal inches from your flesh. It’s a good thing to be mentally prepared for such scenarios.

As with U-locks and chains, if you are only locked to other humans, and not an immovable anchor point, the police may attempt to drag you out of the way while you are still attached to each other. There is a real chance of painful injury, including broken bones, in this scenario, because the lockbox greatly limits the degree to which you can bend your arms.

# METAL STRAIGHT BOXES

## MATERIALS NEEDED

- One - 24"-36" length of 1/4 inch thick, 4" diameter pipe
- One - 3.5" length of 3/8" rebar
- One - set of bracelets
- Duct tape, fabric, foam for padding and fitting

Straight boxes are designed to link multiple people together in a row, a circle, or whatever other shape suits your needs to blocking a road or occupying an office. A sit-in formed by people linking arms can be broken apart by police in minutes with sheer force. Utilizing straight boxes, that same sit-in has the potential to last hours or days due to the difficulty of separating activists. Acquire a 24"-36" length of schedule 40, 1/4" thick, 4" diameter steel pipe. This can be cut down from a larger piece of scrap pipe

by any metal shop.

The length of the pipe should be custom sized to the reach of the lock down person's arm.

Prepare a 3.5" metal pin for the inside of the lockbox from

a steel rod or piece of 3/8" rebar. Use a hacksaw to cut the pin to size. Drill a hole, slightly off-center to the width of the pipe, perpendicular to the length of the pipe and at the center point of its length. Insert the rod or rebar pin. It should sit slightly closer to one wall of the pipe than the other, if you drilled the hole correctly off of center. This creates more hand room inside the box at the pin point where the lock down person will have to be maneuvering their hands to clip in and out of the box.

Spot weld the ends of the pin to the walls of the box. File smooth the pin-end welds and the pipe-end cuts. A thin layer of foam padding can be glued to the inside walls of the box, or rags can be duct taped to the ends of the box to increase comfort for the lock down person and obscure internal inspection of the box by those trying to break them out. Wrap the entire lockbox in several layers of duct tape. This will obscure what material the lockbox is made of, help to hide the location of the center pin, and may also gum up grinders.

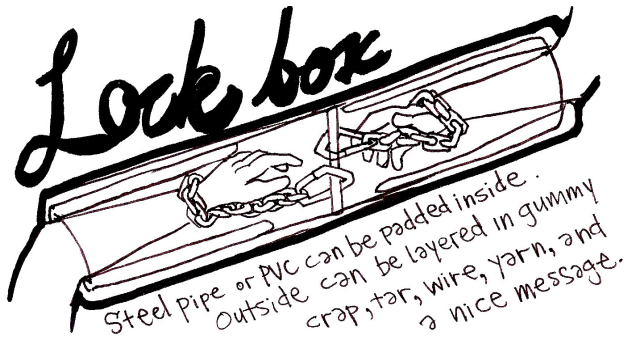

# METAL BLACK BEARS

Ninety degree lockboxes, or Black Bears (as they are called where they were born in Cascadia), expand lock down opportunities and make more difficult lock down positions less difficult to hold. Black Bears have been used successfully to lock down to heavy machinery at mine sites, blockade logging road gates, and lock activists to vehicles in urban situations. They have also been used to reinforce tripods, treesits, and other aerial blockades. The 90 degree angle is naturally more comfortable for the position of your arms and will not put as much strain on a person's shoulders, elbows, or wrists as a straight box. The angle also allows people more room to reach around bigger objects, such as heavy equipment parts, vehicle axles, steel gates, etc.

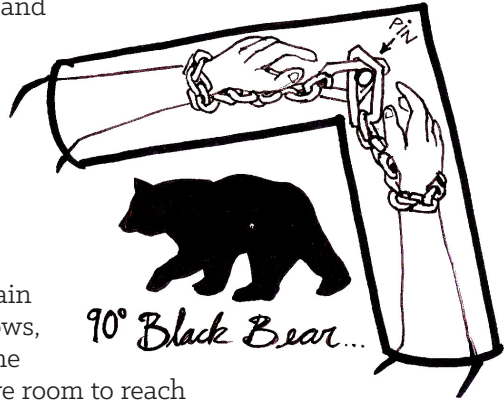

Take a 30" length of 1/4" thick, 4" diameter steel pipe and cut it in half at a 45 degree angle. Flip one piece 180 degrees so that you have a 90 degree box when you rejoin the cut pieces. Grind the outer edges of the cut pieces of pipe to create a very subtle groove along the outside perimeter of the box where the two pieces will join. This groove is needed to lay the weld that will rejoin the two pieces. Gently file and sand the inside edges of the cut pieces of pipe so that the lock down person does not cut their hands.

Prepare a 3.5" metal pin, for the inside of the lockbox, from a steel rod or piece of 3/8" rebar. Use a hacksaw to cut the pin to size. Wedge the pin into one of the cut ends, perpendicular to where the two pieces of pipe will join, on the center point of the cut edge, and spot weld it into place. Slightly offsetting the pin from center is not necessary because the 90 degree angle created by the rejoining of the two cut edges naturally provides more hand room at the pin point for the lock down person to maneuver.

Grinding shallow seats for the pin-ends into the cut edges of the pipe and spot welding the pin-ends in these seats will keep the pin in place once the two pieces of pipe are re-welded together. Tack the two cut pieces of pipe together with a few spot welds. Weld a thick bead into the

groove where the two pieces join. Bring it all the way around and back to where you started. File down the sharp edges so no one gets cut.

**NOTE: Activists have experienced problems with pins breaking out of Black Bears. This could lead to injury if someone is carrying a Black Bear by the pin with one hand. If the pin breaks, the box would drop, potentially crushing someone's foot. Ouch!**

## PVC STRAIGHT BOXES

### MATERIALS NEEDED

- One - 24"-36" length of 4" diameter PVC plastic pipe
- One - 3.5" to 4" length of 3/8" rebar or 4" bolt and nut
- Epoxy or Guerilla Glue
- 2 or 3 feet - Chicken wire
- Duct tape, yarn, roofing tar, nails, sand
- PVC glue (for 90 degree version)

Sometimes it's hard to locate metal pipe and a welder. Or perhaps your affinity group isn't inclined to lug ten 30 lb. lockboxes up a mountain. Don't fret! There is another option: PVC pipe. They are also much lighter, and don't require specialized tools to fashion into lockboxes.

PVC lockboxes were first used to help successfully shut down intersections surrounding the 1999 WTO meetings in Seattle to great effect. They were devised to be lightweight, discreet, versatile and easily mass-produced. They worked great—until martial law was declared and the pepper spray and tear gas started flying!

PVC is not very strong on its own. In order to make your lockbox more durable our experts in research and development have devised a special blend of tar, yarn, duct tape, and chicken wire to make it a major pain in the ass to cut through these things.

Start off with a 24"-36" length of 4 inch diameter PVC plastic pipe. The pipe comes in 8 or 10 foot sections at the hardware store and is easily cut to size with a regular old hand saw. Remember, custom fit is essential to the effectiveness of your action. Prepare a pin for the box out of steel rod or 3/8" rebar. It works best to drill a hole through both walls of the box, then cut the pin to fit flush with the outside walls of the box. Glue the pin caps in place with epoxy glue. Since the pin is the only thing holding you in, it's a good idea to place it slightly off-center in the pipe in order to keep the cops from guessing its location.

Another option for a pin is to use 2 nuts and a bolt that is over 4" long.

Drill your holes slightly off center and insert the bolt through the first hole. Reach into the lockbox and screw the nuts on far enough so that you can get the end of the bolt through the other hole. Now screw one bolt all the way to the top, and one all the way to the bottom of the bolt, so that both bolts are pushing against the inside wall of the lockbox. This should hold the pin firmly in place. Apply epoxy to both nuts to hold them in place. Cut off any parts of the bolt that are sticking out from the outside of the lockbox. For good measure cover the top and bottom of the bolt with epoxy as well. You can also just put the bolt through the lockbox and screw the nut down on the outside to hold it in place, but it will protrude from the lockbox making its location more obvious to the police. Slather it in epoxy to make it more difficult to remove.

Next, wrap the box in two layers of chicken wire. Make sure you bring the wire all the way out to the edges of the box. Twist it around itself tightly against the box. Feel free to weave other pieces of metal such as coat hangers or nails into the chicken wire for extra reinforcement. Now use a large paint brush to glob on a thick coat of roofing tar over the chicken wire. The tar does an excellent job of gumming up saws and grinders. Roofing tar is strong stuff, so do this in a well-ventilated area with gloves and a mask. If you feel inclined, wrap a bunch of yarn around the tar; some say this helps to clog up the grinders police use to cut you out.

Now roll the lockbox in sand so that all that tar is covered by it. After the sand, it can be helpful to wrap the lockbox in Saran Wrap to reduce the mess before applying the last layer. Finally, wrap a few layers of duct tape around the entire box in order to conceal all those goodies lying in wait. You're done!

The cops may assume they are dealing with metal lockboxes and either decide either to wait you out or use a grinder to cut you out. Or they may try to dismantle it layer by layer, which tends to get frustrating once they get to the tar.

# PVC BLACK BEARS

You can easily make a 90 degree Black Bear PVC lockbox. The only additional purchases you need to make are some PVC glue and a piece of 4" diameter 90 degree PVC elbow joint available at the hardware store. You will take your 24"-36" piece of 4 inch pipe and cut it in half. Read the instructions on the PVC glue for proper use. Coat the end of each piece of straight PVC pipe in glue and insert into both ends of the elbow joint. Immediately give each pipe a twist inside the joint to spread the glue and let sit for a few minutes while it cures. The elbow joint will add an inch or so in length to the lockbox, so double check the fit before you start reinforcing it. If it is now too long, cut the ends as needed. Follow the instructions for reinforcing the straight PVC lockboxes and you will be ready to rock.

## REMOVAL

See *Lockboxes*.

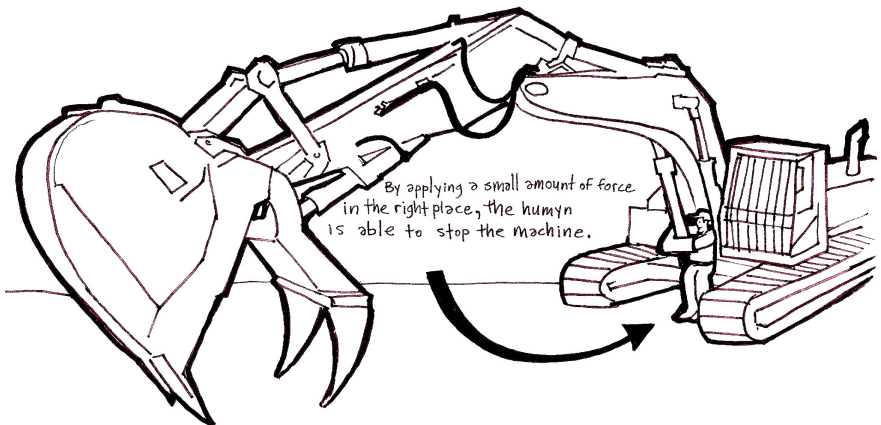



# >>> SUPER BOXES

- + Extremely difficult to remove
- + Law enforcement less familiar with them
- Very heavy
- Hard to conceal
- Exposes blockaders to cops/opponents

Concrete Super Boxes are straight boxes at the core, reinforced by a sheath of concrete and coiled bailing wire that is encased in an outer sleeve of metal pipe or plastic drain tubing. They were innovated in 1995 by Headwaters Forest activists in Northern California whose Straight Boxes were being repeatedly cut through by Humboldt County Sheriffs. Now, Sheriffs spend hours cutting, chipping, grinding, hammering and chiseling activists out of these concrete reinforced Super Boxes. Super Boxes are more difficult for law enforcement to dismantle than regular boxes, but they can be more uncomfortable for a person to use and should be used with extreme caution. Identifying safe lock down positions, long before the action, which will not injure the lock down person's wrists or dislocate that person's shoulders is essential. Resting points for the weight of the Super Box are especially important in this respect, because the Super Box, not the person using it, must carry the weight of the Box while the person is locked down. The best position is for the Box to be laying on flat ground. This can usually be achieved around a gate or connected to a line of other people on a road.

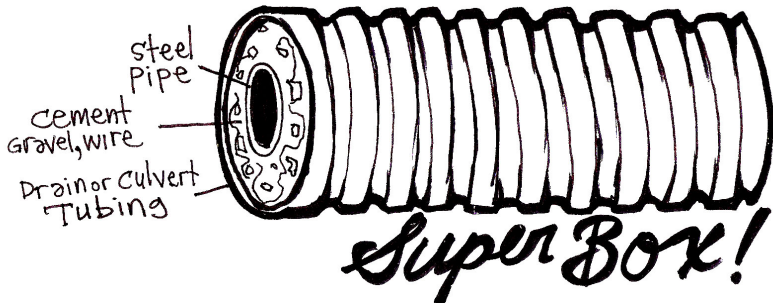

Even though Super Boxes are extremely heavy, regular heavy duty steel pipe should be used if possible for the inside pipe and outer casing. If regular pipe is not attainable in the 8"-10" diameter size, the outer casing can be made from thin aluminum or plastic drain tubing. The strength of the Super Box is in the combination of materials used, not any one material. A diamond saw will cut through a regular steel lockbox. Multiple tools are required to cut through the different materials in a Super Box.

## **MATERIALS NEEDED**

- One - 24" to 36" length of schedule 10 to 40 thickness, 4" diameter aluminum or steel pipe
- One - 24" to 36" length of schedule 10 to 40 thickness, 8" diameter aluminum or steel pipe or corrugated plastic drain tubing
- One - 8" long steel rod for the lockbox pin (3/8" rebar works)
- One - bag 2" flat head nails
- One - coil of bailing wire or a 2' X 1' length of chicken wire
- One - small ball of yarn
- One - small bag premix concrete

## **TOOLS NEEDED**

- Hacksaw
- Hi-speed metal drill
- 1-5 gallon mixing bucket
- Mixing stick or trowel
- Heavy rubber gloves
- Air respirator
- Large pouring cup
- Wire cutters
- 2-4" diameter plastic container lids
- One - tube crazy glue
- One - roll of duct tape

## **CONSTRUCTION**

Size the lockbox to the lock down people. Cut the lockbox and the outer sleeve to size. Prepare an 8" metal pin for the inside of the lockbox from a steel rod or piece of 3/8" rebar. Use a hack saw to cut the pin to size. Drill a hole slightly off center through the lockbox pipe, perpendicular to the length of the pipe, at the center point of its length. Insert the rod or rebar pin. It should fit tight so concrete does not flow in around the edges when poured between the box and the outer sleeve. It should also sit slightly closer to one wall of the pipe than the other to create extra hand room, just as was explained for the Straight Box construction.

Insert the lockbox in the 8" outer sleeve. The pin should protrude approximately 1.5" from either side of the lockbox and rest flush against either side of the outer sleeve. Remove the outer sleeve. Super glue the 2" nails to the outside of the lockbox by their flat heads, spacing each nail about one square inch from the others. The lockbox should look like a pin cushion now. Insert the lockbox in the outer sleeve again. The pin and nails should be protruding equally and rest flush against the

outer sleeve. Remove the outer sleeve. Now, coil the bailing wire up and down the length of the lockbox on the nails. This will complicate law enforcement efforts to cut/break through the concrete. Zigzag it from one end of the box to the other, but avoid wrapping it around the box. The idea is to create a wire web within the 2" sheath of concrete that will exist between the lockbox and the outer sleeve. Don't make the weave too thick or else the concrete will not pour evenly and there will be air pockets which will weaken the concrete.

The concrete sheath is made by standing the entire Super Box upright on a flat smooth surface over a piece of plastic. Do this in a discreet, warm area where the concrete can set for three days. Cap the two ends of the lockbox with the plastic container lids and duct tape them down to prevent concrete from falling into the lockbox. Insert the lockbox, armored with the nails and wire, in the outer sleeve. The lockbox should fit snugly inside the outer sleeve.

Prepare the premix concrete to a thick, oatmeal consistency in the 5 gallon bucket. Use rubber gloves and a respirator. Pour the concrete with a large cup into the 2" space between the lockbox and the outer sleeve. Make sure that the wire doesn't bunch up and that the concrete is spreading evenly. Pound the sides of the outer sleeve to fill in any air pockets that may form. Add pieces of yarn as you pour the concrete. This will complicate destruction of the Super Box as well. Finish filling in and packing the concrete and leave the whole thing to dry three days before moving. Use quick set concrete activator if your action is two days away and you are pressed for time.

## **REMOVAL**

Police will likely have to use a variety of tools to get you out of superboxes. This may include diamond grinders, sledge hammers, picks, even pneumatic jack hammers to get through that reinforced concrete. They may be crazy enough to try to move the superboxes with a dolly, forklift or other heavy equipment while you are still attached. This is very dangerous and could lead to severe injury to the people locked down.

# >>> BRACELETS

How do you lock into a lockbox? You will need to construct two chain bracelets which will allow you to attach your wrists to the center pin in the lockbox. A carabiner at the end of each chain bracelet allows you to clip in and out as you please, but makes it impossible for the cops to just pull your arms out.

## MATERIALS NEEDED

- One - 12"-15" length of 1/8" thick steel chain
- One - large 3.25" spring clip
- Either a 5/16" nut and 1"x 5/16" bolt OR a small 2.5" clip

Climbing carabiners or dog leash clips also work in place of the spring clip. Carabiners are pricey and the strength they afford is unnecessary. Clips are spring-loaded, open-gate devices that resemble a mini carabiner. They sell for about one-third the price of a carabiner and will not break before your wrist does under pressure. Make sure the large clips open wide enough to clip around the lockbox pin. All these materials are available at any hardware store.

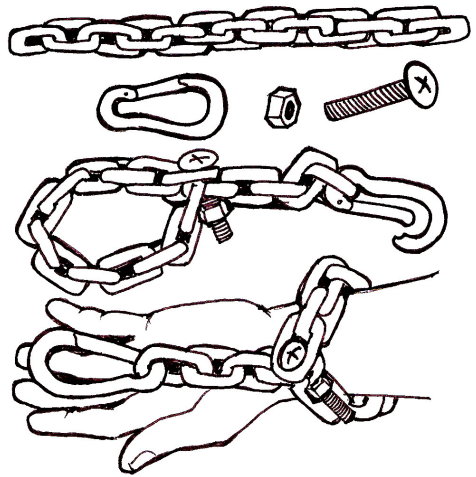

## CONSTRUCTION

Attach the large clip to one end of the chain. Wrap the chain around your wrist joining the free end link with another link at the point that the chain is snug around your wrist. Next, fasten these two links together with either the nut and bolt or a small clip. The nut and bolt method is less expensive and will bind the chain snug around your wrist. Pass the bolt or small clip through the two links, screwing the nut onto the bolt, or releasing the clip, through the other end of the links. The chain should be joined around your wrist now with the large clip dangling from the excess chain. You should be able to hold the large clip with your thumb and index finger. Keep your thumb on the open gate side of the clip and practice opening and closing it. If the clip dangles beyond your thumb, there is too much slack in your chain. Move the clip up the links of the chain to take in the slack. Repeat this process for the other wrist. Finally, reach your arms into the lockbox and clip each large clip around the center pin.

Bracelets are inexpensive, completely adjustable, and allow blockaders fast, safe, in-and-out lock down access. But, there are two things to keep in mind when using bracelets: The chain length must be as short as possible and the amount of space between a person's arm and the wall of the lockbox must be minimal. It is extremely important to keep the chain length as short as possible, because if someone can pull your arm out of the box far enough to expose, or even simply reach the chain link, it will be easily cut with an ordinary pair of bolt cutters. If a person's arm is not snug with the wall of the box, someone could reach a tool down through this space to get at a person's chain and cut it. Measure the diameter of the lock down person's forearm before you select the pipe. People with smaller forearms may fit more snugly into 3.5" diameter pipe instead of 4". Fill the space between the person's forearm and the wall of the box by wrapping rags and duct tape around the person's forearms. These essential measures will prevent all your hard work from going down the toilet. It's a good idea to sew some padded fabric around the chain, or wear a sock on your wrists for extra padding. You can also run the chain through a piece of tubular webbing for the same effect. Cops will often try to pull your arms out of the lockbox and a bare chain can be rough on your wrists

**NOTE: It's a good idea to sew some padded fabric around the chain, or wear a sock on your wrists for extra padding. You can also run the chain through a piece of tubular webbing for the same effect. Cops will often try to pull your arms out of the lockbox and a bare chain can be rough on your wrists**

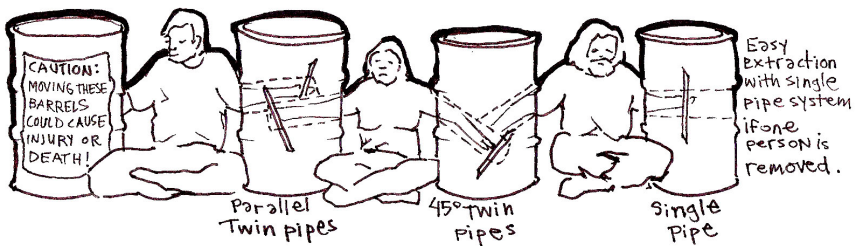

# >>> BARRELS

- + Very difficult to dismantle
- + Fairly easy to construct
- Must be prepared days or weeks in advance
- Difficult to transport and deploy
- Uncomfortable for blockaders over time
- Exposes blockaders to cops/opponents



Barrels are concrete filled 55 gallon drums fitted with lockboxes. Each barrel weighs in at approximately 1,000lbs. Barrels are excellent for both urban and backwoods blockades. They work very well on roads, in front of gates and building entrances, and across train tracks and boat launches. In 2008, Blue Ridge EF! successfully shut down the work at Dominion's Wise County coal plant with activists locked to 8 barrels in front of the entrance to the construction site.

How many barrels you use is dependent upon the width of the passage that needs to be blocked and the number of people committed to locking down. Even at the narrowest sections, most logging roads, gate entrances, etc... require 2-3 barrels. Three barrels with 4 people locked down to them creates a solid blockade and powerful visual image. If you are having a hard time coming up with barrels, trash cans can make a suitable substitute.

## MATERIALS NEEDED

- One - 55 gallon drum
- Two - 90 pound bags premix concrete
- Two - 15"-17" lengths of 4" diameter PVC or steel/aluminum pipe, or rolled cardboard
- Eight - 2'lengths of 3/8" rebar
- Two - 5 gallon plastic mixing buckets
- Two - Large plastic drop cloths/tarps
- Two - Concrete mixing trowels
- One to two - 5 gallon water jugs
- Two - 4" diameter PVC pipe caps ie., duct tape, plastic containers lids
- Six - Pair work gloves
- Six - Air respirators/bandanas
- Two - Buckets very small debris; 1/4" rock/brick/gravel chips, nails, nuts, bolts, golf balls, cable, chicken and bailing wire, etc ...
- One - Ball yarn

## **PREPARE THE BARRELS**

There are two systems of barrel design. These are the single and twin lockbox systems. Both systems use either PVC or aluminum/light steel pipes or rolled cardboard and rebar. The twin lockbox system is stronger than using one long lockbox that two people share. With the single system, if one person is forced out, the other person is easily removed by reaching through the removed person's side and cutting the other locked down person's chain which is exposed. With the twin system, each person is locked into an independent box that is reachable from only one side of the barrel. Conversely though, two boxes side by side, or even one on top of the other, displace more concrete and can weaken the integrity of the concrete, making it easier for the police to extract you.

Construct the barrels in a discrete, warm, spot with easy vehicle access when the time comes to move them. First, cut 4" diameter circular holes at mid height through both sides of the 55 gallon drums. The easiest and quickest way to cut the holes is with an acetylene torch. Another way to cut the holes is to drill a pilot hole, with a high speed drill, in the middle of the circle outlining each hole. Then, use a jigsaw or a "sawzall" with a high speed metal blade to cut the holes out from there.

***WARNING - Wear eye protection. Blades frequently break, and metal shards fly all over the place.***

For the single box system the holes need to be lined up on both sides of each barrel. For the twin, each hole needs to be slightly offset and positioned at an opposing direction from the other hole along the horizontal center-line of the barrel. Think about it. You are creating spaces for two independent boxes to run parallel to each other. The boxes need to be able to lay evenly, side by side, inside the barrel, with room for the concrete to fill in around them. Wheat-paste warning signs on the barrels stating that the barrels weigh 1,000lbs. each and that the slightest disturbance of them could cause death or dismemberment to those attached or those causing the disturbance.

## **FIT THE LOCKBOXES**

You have three choices for the structure of the lockbox: PVC pipe, aluminum/steel pipe or rolled cardboard. Although PVC is easy to work with, abundant and inexpensive, it can be somewhat easily broken through. Lightweight aluminum or steel pipe, schedule 10 thickness, is much more durable, yet you can still cut it to size with a hacksaw. Rolled cardboard is another material that can be used as a form for the concrete to dry around in the shape of a barrel box. Cardboard is simple to work with and dumpster-divable. It creates a form that is easily removable when the concrete is dry around it. But, it is important to note that this



design is much more dangerous than the others because if they smash the barrels to break the lock down people out, the concrete will collapse around their arms, crushing them. You might ask, "Why even risk this?" The thinking behind this structure is that by explaining this to the cops, with the threat of a lawsuit, chances are they won't try shattering the barrels. But that is putting an awful lot of trust in the police.

Once you have chosen your lockbox pipe structure, you are ready to choose either the single or twin lockbox system. Cut the pipe to the full width of the barrel for the single system. The single system is one continuous lockbox, spanning the full width of the barrel, cut flush at the hole ends of the barrel. Then, set the 2' long, 3/8" rebar pin at a perpendicular angle through the middle of the pipe, at the pipe's center point. For the twin system, cut the pipes at approximately 17" lengths. The pins are set perpendicular through the pipes as well, but 2" from the inner ends of each of the pipes. Set the pins by first drilling 3/8" holes completely through the pipes at the inner ends and then wedging the pins through the holes. Cap the inside ends of the twin lockbox pipes with tight fitting plastic containers/lids and duct tape these on securely to prevent concrete from getting inside the lockboxes.

Insert the pipes to fit lengthwise through the holes in the barrel. The single box should fit securely from hole end to hole end. The twin box system is a bit trickier to set. Wiggle the twin boxes into place side by side. The inside pin ends of the boxes should terminate in the middle of the barrels where they will be safely surrounded by as much concrete as possible. The outside ends of the boxes should be nearly flush with the hole ends of the barrel, just slightly protruding from each of the hole ends. Once you find the right fit remove the lockboxes.

## **POUR THE CONCRETE**

Begin by laying down drop cloths/tarps and mixing concrete with water in the mixing buckets. Stir the water into the concrete until a thick, lumpy, oatmeal consistency is reached. Then, pour the concrete into the barrels. Alternate a bucket of straight concrete with a generous sprinkling of chip gravel and small, random debris. Big, bulky debris weakens the structural integrity of the crete. Add 6 or so 2' lengths of rebar into the mix at opposing angles and weave yarn and bailing wire all around them through the mix. Chicken wire should also be laid around the lockbox area.

When the fill reaches the level of the lockbox hole cuts, reinsert the lockboxes. Finish pouring the concrete and debris, filling the barrels to the brim. Let the concrete dry and set. This takes up to a month for real strength; no less than a week, without quick set. **If your action is less than a week away, use a concrete quick set accelerator.**

## **TRANSPORT AND DEPLOYMENT**

Arrange for the use or rental of a heavy duty, 1.5-2 ton truck/van to move the barrels. Remember, the barrels weigh over 1,000lbs. each. There are two ways to move the barrels onto the transportation vehicle. The first is to pull the vehicle up to where you made the barrels and raise them onto the vehicle with an engine hoist. Lift the barrels onto the transportation vehicle by running a heavy duty chain through the engine hoist and tightly around the mid section of each barrel. Slowly and carefully raise and swing the barrels onto the vehicle. Secure the barrels on the vehicle by wedging them together and strapping them down with heavy duty canvass, rope, or chain. No one should ride with the barrels.

If they roll, you die! It may be possible to pull up to your deployment spot and crudely roll the barrels off of or out of the vehicle. Roll them into place and muscle them upright, then lock down, Be extremely careful!!!. This way is slow and requires incredible group coordination and strength. It is also very dangerous. Someone could easily be crushed, pull muscles, get badly cut on a sharp edge, etc... Have a back up plan and pay extremely close attention to everyone's safety.

Another way to move the barrels is with heavy duty moving dollies—the kind with a clamp strap and wheel drop-out lever designed for moving large, heavy objects like refrigerators. The vehicle will need to have a hydraulic deck that can be lowered to the ground to be able to roll the barrels directly onto it.

Any moving agency has these trucks and dollies available for rent. Home Depot also rents pickup trucks that have a hydraulic lift. The dollies allow you the freedom to wheel right up to your transportation vehicle and load the barrels while keeping them on the dollies by dropping out the wheels.

To unload the barrels, simply raise the wheel lever and wheel them off the lowered truck gate. This way is much faster and a whole lot safer than rolling the barrels around by tooth and claw and muscling them upright and into place. Dollies are also quiet and somewhat discreet. Disguised as delivery persons with sheets covering the barrels, activists have successfully delivered barrel blockades in even the busiest urban settings.

When setting the barrels in place, it is very helpful to have two people stretch a measured string across the length of the blockade area, which has been pre-marked where the barrels should stand. The string should

be marked at the distance each barrel needs to be placed from the next in order for the lock down people to fit their arms into the barrels comfortably. If everything goes well, and you have the ability to reload the barrels, you may even have the opportunity to reclaim them after your demands are met!

## **VARIATIONS**

In the event that your affinity group is not excited about moving a 1,200 lb. barrel, there are a few lighter weight models available as well. Smaller 30-35 gallon garbage cans also work for concrete barrel forms and are easier to transport and less expensive to construct than 55 gallon drum barrels. You can also mix Styrofoam packing peanuts into your concrete at the same ratio you would normally mix in gravel, to lighten the load. If you want to go super lightweight you can fill the barrel with spray foam insulation—the stuff that comes in aerosol cans. Fill the barrel with chicken wire and assorted metal objects as you would to reinforce concrete; it will make it far more difficult to remove the insulation. You can top the barrel off with a few inches of concrete to give police the impression that it is solid cement. If you are going to top it off with concrete make sure you have put some extra weight in the bottom of the barrel. A top heavy barrel is more likely to tip over and injure the person locked down.

Lockboxes can also be sealed into refrigerators, sofas, washing machines, etc. to create free standing, mobile lock down devices like barrels. Giant log sections also work very well as lock down devices. New Jersey Earth First! activists successfully deployed a giant stump sit, blockading the entrance to a local Georgia Pacific lumber yard in 1991 with a line of three-foot high log sections which were stood upright between the activists and locked into. They drilled 4" diameter holes into the sides of the stumps with a huge auger bit then screwed eye bolts into the roofs of the holes at the centers of the stumps. The eye bolts functioned as lockbox pins that the activists clipped their bracelets onto. This one stumped 'em at the yard for hours!

## **REMOVAL**

See *Superboxes*.

# >>>BATMOBILES

- + Quick, easy and inexpensive
- + Solid road blockade, not easily removed
- Not very discreet moving into position
- Exposes blockaders to cops/opponents
- Legal issues surrounding vehicle ownership

**“DUNNA NUNNA NUNNA NUNNA NUNNA NUNNA NUNNA NUNNA NUNNA .... Lock down!”**

Another crafty blockade is the Batmobile. The Bat is nothing more than a junker car hauled up a road and dumped across it so that people can lock down to at various points. The EF! Roadshow’s tour van made its final stop in the middle of a logging road in Oregon in 2009. After flipping the van on its side, activists locked down inside the van, where along with treesits, they blockaded the road to an old growth logging operation for three days. Attendees reported that it was the best presentation of the entire tour!

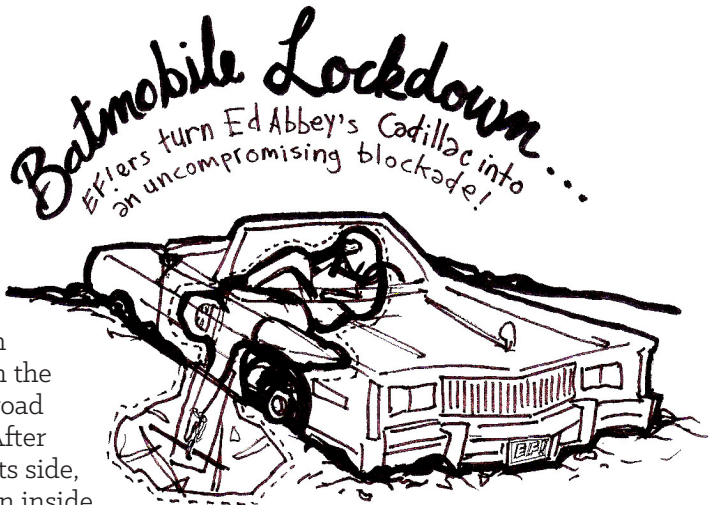

People can flip the Bat on its side to provide easier access to lock down to the front and rear axles. Holes can also be cut in the frame of the car that people can lock to each other through or dig a sleeping dragon under the Bat and lock through a hole in the floor or side. Do not flip the car on its side unless you are sure that you can stabilize it. The last thing you need is someone being injured or killed by your own blockade. Or, people can simply barricade themselves into the vehicle. Banners, signs, and spray paint emblazoned messages can be tagged on the Bat graffiti style as finishing touches.

## MATERIALS NEEDED

- One - Junker car
- One - Tow vehicle
- One - Tow rope/cable or vehicle dolly
- Two or three - Lockboxes
- Two or three - Sleep pads/butt cushions
- Acetylene cutting torch or high speed drill and jig saw
- Miscellaneous tools; hammer, screw drivers, hack saw, cable and bolt cutters
- Banners, signs, spray paint

## SITE SELECTION

Picking a spot in a road that one or two junker cars can successfully blockade is key. Look for narrow points in roads around turns, over bridges, even at gates. Visualize what the blockade could look like; how should the Bat be positioned, where should people lock down to it. Keep in mind the proximity of the blockade to the point of whatever destructive operations the blockade aims to disrupt. A healthy distance would be a couple of miles from this point, or at least out of reasonable walking range to it. Avoid wide points in roads or areas with flat, broad shoulders which are easily traversable. High speed zones should also be avoided to minimize accident risk. Additional blockades or warning systems should be placed ahead of the Bat blockade to ensure everyone's safety.

*pinch points*

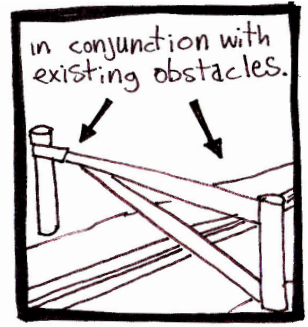
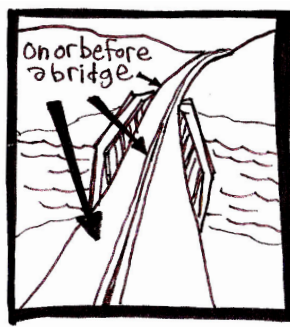

## **PREPARE THE BAT**

Once the site and blockade scenario have been chosen, the Bat must be improved to meet your blockade needs. First we come to the problem of vehicle ownership. It is exceedingly difficult to get a vehicle that is not attached to someone's name. So the vehicle owner needs to be OK with the potential legal repercussions of their vehicle being used as a blockade. To circumvent this sticky issue some activists choose to remove all of the Vehicle Identification Numbers (VIN) on the vehicle as a way of hiding the ownership. The VIN is located on several parts of the vehicle including but not limited to, the engine, dashboard, door frame, under the hood, and on the car frame. To get rid of them use a grinder to grind them away. **HOWEVER IT IS A FEDERAL FELONY TO REMOVE VIN #'S FROM A VEHICLE.** We do not know of anyone ever being charged with this in association with a blockade (though some have been threatened with it), but there is a first time for everything, so take it into careful consideration before doing it.

Next, holes may be cut through the floor board, back seat, or trunk of the car to accommodate people wishing to attach themselves to each other from either ends of these holes through lockboxes. If people intend to barricade themselves in the Bat, all key holes must be jammed and all window crank cables and door handle and door lock cables must be cut or disconnected to prevent, or at least delay, any unwanted break-ins. The wheels should be removed, or at least the tires flattened, to make removal of the Bat more difficult than it already will be. Because removal of the wheels may only be possible on site, a wheel removal and relocation team needs to be ready to move with tire irons, wheel jacks and a vehicle to relocate the removed wheels.

## **TRANSPORT AND DEPLOYMENT**

Use a Batmobile that can be safely hooked and towed into position by another vehicle. Junker cars on their last legs of life can also be bought for as little as \$200-\$400 and may actually be driven into position. If the Bat is dressed for success with lots of glitzy painted slogans before you tow it, you may need to disguise it with a cheap car cover, tarps, sheets or plastic bags. Before you reach your destination, have a plan as to how you are going to dump the Bat. You may need to back it into place to avoid trapping your tow vehicle behind it—now that would be embarrassing wouldn't it.

Activists should caravan to the spot in stages. Security look outs should be posted with radios to prevent any sudden surprises by law enforcement. People may need to be dropped off ahead of the Bat in preparation to deploy it quickly on arrival. It's a good idea to have the

driver remain in the tow vehicle while the Bat is being deployed in case a fast get away is necessary.

The Bat is easiest to move with the tow car, so try and move it as close as possible with the tow car to the drop spot. Once the Bat is dropped, the tow vehicle should take off and people should muscle the Bat around. Flipping it on it's side is very dramatic and gains lock down people easy access to the front and rear axles of the Bat. It also makes a pretty picture for the media. Be extremely careful though. Make sure the Bat is sitting solidly on its side and will not be blown over or easily knocked over before people lock down to it. In the heat of the moment, someone could easily get hurt or even crushed as the Bat is being tossed around. Lock down positions may be uncomfortable. Wear warm, protective clothing and use a sleep pad or cushion for butt comfort.

### REMOVAL

If people are only locked inside the car, the police may have it towed out of the way while you are still in it, as was discovered by Katuah EF!ers blockading the Tennessee DOT headquarters to protest a new road through the Smoky Mountains. It can be a bit embarrassing. This is less likely to happen if the wheels are removed, the car is flipped over, or people are locked to the outside as well. In that case you can expect them to use diamond grinders, jaws of life, or good ol' fashion brutality to get you out.



*The End of the Road (show).*



# >>> SLEEPING DRAGONS

- + Extremely difficult to remove
- + Ultimate surprise
- + Can be installed months in advance
- Requires “night work”
- Exposes blockader to cops/opponents
- Potential for heavier charges for damaging road

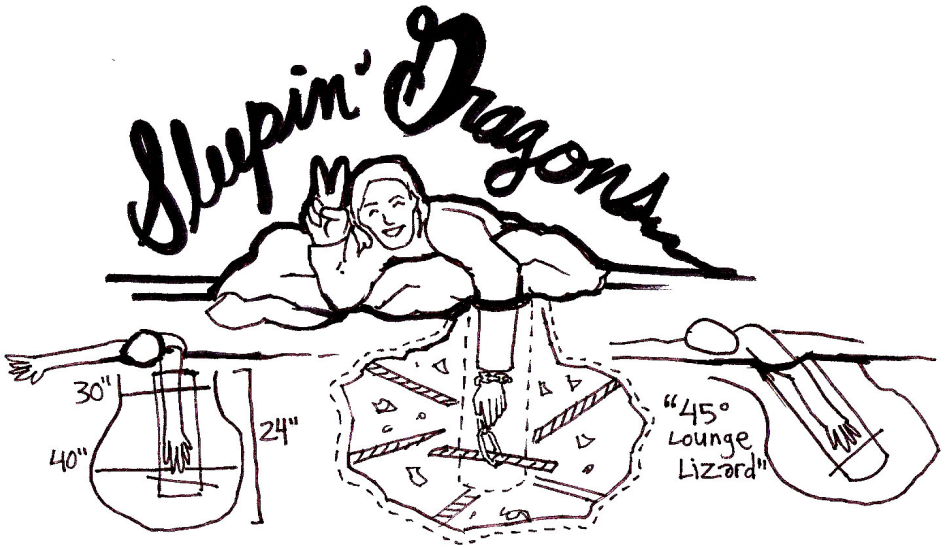

Dragons are essentially concrete reinforced lockboxes buried in dirt/gravel roads. Dragons simulate barrels in that they are extremely heavy and difficult to remove devices. In addition, they are easily concealed and actually built on the site they are to be used. Australian activists devised these sneak attack devices fighting to protect Australia's great coast rainforests from road building and development throughout the 1980's and 1990's.

Essentially, there is one “Sleeping Dragon” design and several variations of it that have come to be known by North American activists as the 45 degree “Lounge Lizard,” “Morrison,” and “Batmobile” versions. Each dragon version is easily adaptable to fit the needs of a particular scenario. It is important to remember that installing dragons is strictly a night time operation. Like all “night work,” security is a serious issue. Only 8-12 very close, trustworthy friends should be involved.

## **MATERIALS NEEDED**

- **Five to eight - 90 lbs. bags premix concrete**
- **One - 2' length 4" diameter metal pipe**
- **Two - 4" diameter plastic lids to seal ends of PVC pipe**
- **One - 2' length of duct tape**
- **Four - 3' steel concrete pins or 1/4" rebar lengths**
- **One - Steel mallet/hammer**
- **One - 2' length of 3/8" rebar for lockbox pin**
- **Two - Large plastic tarps**
- **Three to four - 5 gallon water jugs to carry water for concrete**
- **Two to four - 5 gallon plastic buckets for mixing concrete**
- **Two to four - Concrete mixing trowels**
- **Eight - Pair work gloves**
- **Eight - Air respirators/bandanas**
- **Two each - Pick axes, Shovels**
- **One - Steel wrecking bar**
- **Two - Buckets very small debris; rock/brick/gravel chips, nails, nuts, bolts, golf balls etc.**
- **One - Ball yarn**
- **One - Lock down bracelet**
- **Two - Radios/walkie talkies for security**
- **Eight - Flashlights/headlamps with red/blue gel filters**

## **SITE SELECTION**

Despite the fact that dragons are installed overnight; weeks, even months, of lead time is required to assuredly scout and monitor activity in the area where the dragons will be installed. The area needs to be nearly stone cold with law enforcement because putting in dragons is neither quiet nor quick. Locate a narrow portion of a dirt/gravel road that someone laying across, perpendicular to the road, will be able to successfully block to vehicular passage. Turns in the road, points at either ends of bridges, and even spots in close proximity to gates are good locations.

Visualize the scenario. If the road is wide two or even three dragons can be placed side by side. The spot should be at least 1 mile from the point of anticipated logging, mining, development, etc operations. Make certain your position is at least out of reasonable walking range from the point of the operations you're blockading or they'll just walk right past you. Avoid high speed zones and set up additional blockades to prevent accidents.

## **PREPARATION**

Before you depart, gather the materials and 8-12 very close, trustworthy friends. Assemble the dragon's lockbox from the 2' length of 4" PVC/ metal pipe and the 2' length of 3/8" rebar. Like the barrel lockbox, the pin is placed perpendicular to the pipe. Drill a 3/8" hole through the pipe 2" from the bottom end and push the rebar pin through it into place. Cap the pin end of the pipe securely with one of the plastic container lids and some duct tape. Fitting a 45 degree Lounge Lizard will require cutting the top of the pipe off, 4" from the top, at a 45 degree angle.

## **ARRIVAL AND DEPLOYMENT**

Carefully, drive up to the spot you selected. Take your time. When you are certain that no one else is in the area, unload and send the vehicles back down the road with 2 security people. It's good to work in 3 groups; security, digging, and mixing concrete. Someone in the digging or mixing crew also needs to be on security and in radio communication with the roving security team. Mark off an approximately 2.5' diameter circle in the dirt where the dragon will go and start digging. The hole should be slightly more than 2' deep, making the top of the lockbox nearly flush with the surface of the road when the dragon is complete. Four people can alternate digging, shoveling, and shining lights into the hole.

Work quickly, digging down and out, making an hour glass shaped hole approximately 3' wide at the bottom. The road may be hard. Digging can easily take 1-1.5 hours depending on the quality of the road and the shape you're in. Really, the size of the hole is dependent upon what lengths law enforcement is willing to go to dig someone out of the dragon. More often than not, they will try starving the lock down people out or torturing them before they resort to digging them out. Document this!

Two people can begin mixing the concrete nearby while others dig. Concrete dust is toxic and can irritate the respiratory system. Use respirators or bandanas to help protect everyone. Mix the concrete in the 5 gallon buckets over the tarps. Prevent the concrete from spilling off the tarps and all over the road. Dry concrete on a dirt road is very conspicuous. Use the trowels to mix the concrete to a thick, lumpy, oatmeal consistency. Two people can gather rock and gravel, no bigger than tennis ball size, to be added to the concrete as aggregate. When the hole is complete, lower the lockbox into it for a size check. The rebar pin extending from the sides of the box will help stabilize it in the hole. The top of the box should rise nearly flush with the surface of the road. It should be submerged about an inch from the road's surface so it can be covered over very well with fine gravel, dirt, and leaves, etc.

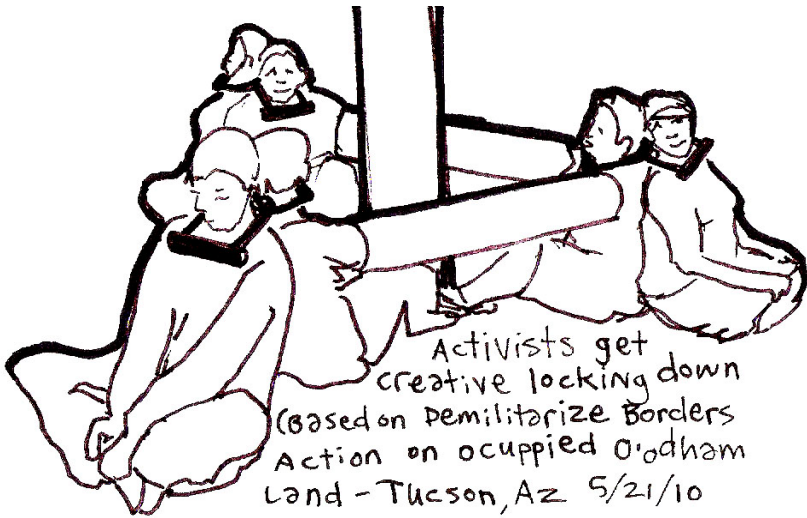

Remove the box when the fit is right, and drive the 4 steel pins into the walls of the hole at opposing angles to each other, spiraling upward, around where the lockbox will be. Reinsert the box into the hole and cap the top with the other container lid and the rest of the duct tape.

Now, you're ready to pour the concrete. Alternate a bucket of concrete with a sprinkling of gravel/rock. Fill the hole around the box to the very top, packing it with the shovel and trowel as it is being filled. When this is complete, cover over the top of the fill and the lockbox with fine gravel, dirt, and leafy debris to camouflage the dragon and let it sleep until it is needed. Pick up and clean up everything. One mislaid glove could ruin everything. Last but not least, figure out a discreet way to mark the location of your dragon. It sure would be a bummer to not be able to find your lock down the day the machines roll in. Cover your tracks and head home. Discreetly monitor your dragon and any other positions you may have up until the time they are needed. Your dragon can sleep for weeks, months, even years to be awoken whenever needed.

#### **45 DEGREE LOUNGE LIZARD VERSION**

Maintaining your position on a dragon over any extended period of time may be very uncomfortable. The force of gravity alone will draw blood down into your arm and cause it go to sleep unless you are regularly flexing your hand around the lockbox pin, making a fist. A design innovation to overcome this lock down complication is the placement of the dragon lockbox at a 45 degree angle to the ground. Simply make a regular dragon lockbox and cut the top end of it off at a 45 degree angle. This will allow the top of the lockbox to lay flush with the surface of the road. The high and low points of the cut should align parallel with the protruding rebar pin at the bottom end of the box so that the pin can support the position of the box while the concrete is poured around it.

## MORISSON VERSION

When the time comes to use the dragon, you may want to bring a metal fire door with you. "The Door" serves as a barrier between the dragon and your body that effectively obstructs any tampering with the dragon. Use either an acetylene torch or a high speed drill and jig saw to cut a 4" diameter arm hole out of the door. Cut the hole the same way you would cut a hole in the side of a barrel. Simply place the door over the dragon when you go to use it. Adjust the length of chain on your bracelet to give you a little extra reach. Two small holes can also be drilled into the bottom end of the door to allow a U-Lock to pass down over one of your ankles and through the door, locking the U-Lock off on the under side of the door. This will securely lock your leg to the door to prevent any unpleasant attempts at separating you from the door in order to get at the dragon. You should wear layers of extra warm clothes and have a sleep pad between your body and the door to keep warm and comfortable because the cops aren't gonna "light your fire." Cattle guards, car hoods, and fences can all be used to reinforce your dragon if a good door is not available.

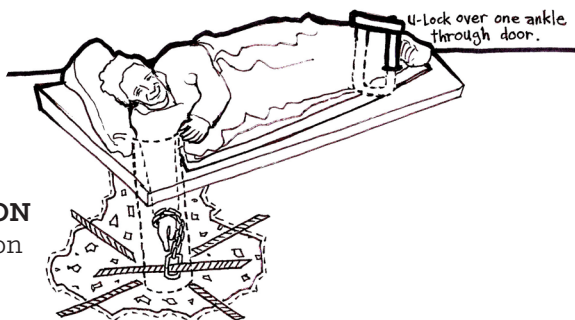

## BATMOBILE VERSION

Drive up to your dragon in style and dump a Batmobile over it for this one. The Batmobile makes those wide, hard to block roads easy! Just remove the vehicle's seats and cut an arm hole in the floor board of the car for the lock down person to reach through and down into the dragon. Tow the Batmobile into position over the dragon and either dig holes for the wheels to fall into, or Jack the car up and pull the wheels off, to bring the chassis as close to the ground as possible. From a prone position, the lock down person needs to be able to somewhat comfortably reach their arm through the floor board of the car and into the dragon. Be sure the length of the person's bracelet chain is long enough to allow them to reach the lockbox pin, yet not so long as to expose the person's chain to the point where it could be cut by law enforcement. Also, make sure that the lockbox fits tightly enough around the person's arm to prevent the cops from getting down the dragon's throat and cutting the person's chain. Extra warm layers of clothing and a cush sleep pad are essential for the lock down person's comfort and an uncompromising blockade.

## REMOVAL

If the police don't decide to just wait you out or otherwise (painfully) coerce you into unlocking, they will probably have to hunt down a few shovels! They will likely need to dig down and around the cement, then they will start breaking apart the cement with sledge hammers, picks, pneumatic jack hammers, and the trusty ol' diamond grinder. Be prepared for hours of loud, jarring noises right next to your head. Rest assured, even after they get you out, there will still be a large crater in the road!

## >>> TUNNELING

*We are only giving brief mention to the tactic of tunneling because it has never been successfully deployed in the US, though there have been a few ill fated efforts, including an attempt to tunnel through 2' of frozen solid ground in the winter in Montana, but that's another story...*

Despite the experiences in the US, the tactic of tunneling has been used to great effect in the UK, especially in the anti-road campaigns of the 90's. The basic concept is to dig and then occupy a tunnel underneath a work site where heavy machinery needs to operate. The idea is that the heavy machinery can't operate on the site without potentially collapsing the tunnel, which would likely result in the death of the tunnel occupants. The tactic was first deployed as a way of keeping cherry pickers from getting close enough to evict treesits, but eventually evolved into a means of stopping work all together on sites. At the Fairmyle protest camp in 1996, it took the cops 7 days to evict a tunnel. And in 2000, activists lived underground for 40 days while occupying a tunnel in an Essex protest camp.

Tunneling is a very dangerous tactic. There are numerous factors to consider when tunneling such as knowing what types of soil are appropriate for tunneling in, preventing the roof from collapsing, ensuring fresh air circulation, disposing of human waste, dealing with claustrophobia, and securing the tunnel entrance from eviction, among other things. If you are interested in researching tunneling more check out: [www.discodavestunnelguide.com](http://www.discodavestunnelguide.com) A pdf of the guide can also be downloaded at: [www.earthfirstjournal.org/directactionmanual](http://www.earthfirstjournal.org/directactionmanual)





# 5

## AERIAL BLOCKADES

***SAFETY DISCLAIMER:*** Before climbing an aerial blockade you must go through an ascending and midline descent training put on by experienced climb trainers. These are not skills you can just pick up from a book. See the Resources section about organizing a training.



# >>> TRIPODS

- + Quick assembly
- + Potential for on-site storage
- + Powerful visual
- Quickly taken out without armoring
- Many police departments familiar with device
- Uncomfortable for sitter over long periods

Tripods are road blockade devices that have been in use for decades all across the world. They are three-legged structures—as the name heavily implies—that are occupied by a person who is then out of the reach of the cops.

Tripods are great for blocking vehicle traffic in a variety of places such as logging roads, parking lot entrances and intersections. They also provide a nice way to get your amazing banner up in the air for all to see. Tripods have been popular for so long not just because of how epic and versatile they are, but also because the materials needed can generally be “gathered” nearby—from trees to scaffolding or fencing poles.

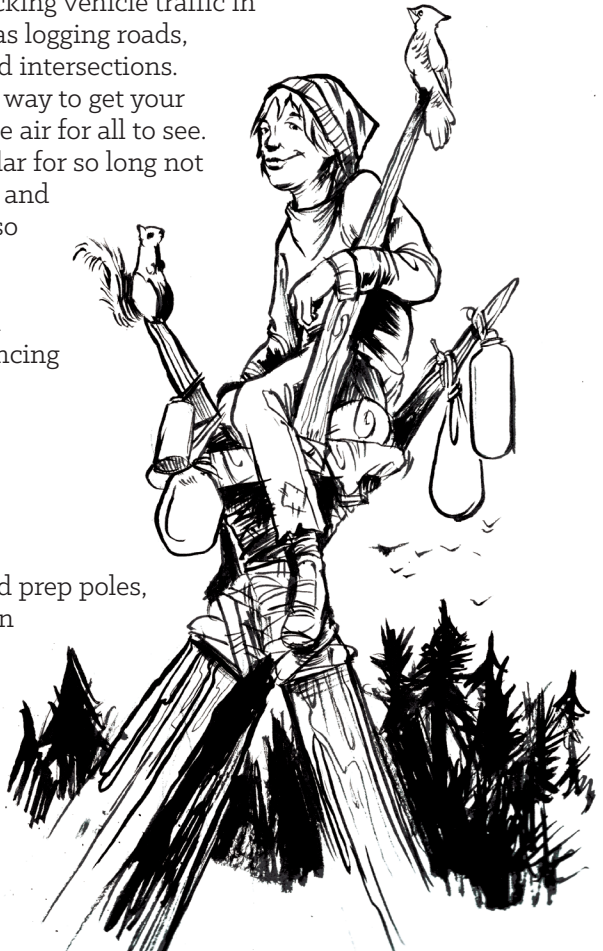

## WOODEN TRIPODS

### PREPARATION TIME:

6-8 hours to gather and prep poles,  
60 + minutes to dry run

### PEOPLE NEEDED:

1 to sit, and 8-14 for  
set up

### COST:

\$50-\$150

## MATERIALS NEEDED

- Three - 25'-40' poles
- One - Bow saw
- 100' - rope for base support line around bottom of poles
- 45'-70' - 11 mm climbing rope (10'-15' for the knot, plus the length of the poles)
- One - Climb Kit (see *Climbing Basics*)

### Optional (for armoring)

- One to three - Steel mallets/hammers
- One - Bolt cutter
- 150 - 6" nails
- 45 - Fence staples
- Three - 1' X 6' lengths of chicken wire
- 100' - Barbed wire
- Four to six - Work gloves
- One - Ball yarn
- One - Axe

## SITE SELECTION

Pick a spot on a road, the narrower the better. Like a *sleeping dragon*, or with *barrels*, you want to find a narrow enough spot on the road that the tripod can completely block traffic from either side. If it's a backwoods type action, look for poles and good pole storage areas nearby alongside the road. Before you use your tripod, be aware of security in the area. Camping out nearby to monitor the situation is a good idea.

## POLE SELECTION

Your life or that of a friend's will be dangling from the poles you pick. So, don't be foolish and gather some rotten, old downed trees. Select three, even sized and straight trees. Choose a species that is light but not too brittle—many coniferous trees are suitable, but avoid white pine due to its brittle qualities. If you are in hardwood forests, tulip poplar is fairly light and grows straight and tall. The poles can be selected from adjacent old clearcuts, where monoculture tree plantations are quickly replacing the native diversity that once flourished. Lay aside your guilt for cutting down young trees with the knowledge that this has to be done to prevent the destruction of the entire area. Remember you and your friends will only be safe with solid poles.

The trees should be 4" - 6" in diameter at the base and at least 2.5"-4" at the top. Delimb them with an axe or bow saw. Move them to the storage area. Weight and maneuverability are major factors in transporting the poles. They are most easily moved by a few people with webbing slings that are simply girth hitched on, making a convenient handle.

## ARMOR AND STORE THE POLES

Once in place, begin armoring the poles. When working with wooden poles if they are not reinforced with metal, wire, and yarn, your tripod can be cut down by workers and cops with a chainsaw. To armor the poles, first wrap the yarn up and down the base of each leg. Next, lay the chicken wire over the yarn by wrapping it around the base of each leg and secure it with the fence staples. Cover the legs 6'-8' up. Then, drive about fifty 6" nails through the wire into the legs. You can also wrap barb wire up the legs, but this makes the tripod difficult to carry and climb. The barbed wire is best

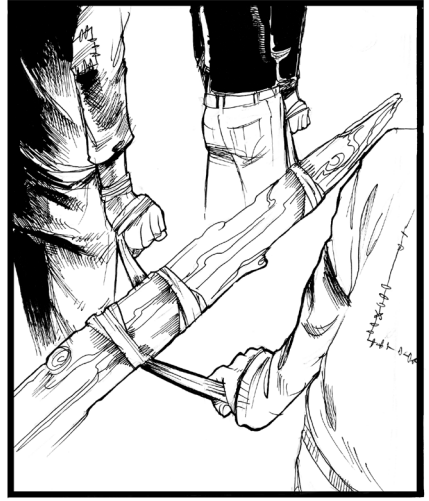

saved to run around all the legs when the tripod is up. When a chainsaw hits a nail it can be very dangerous for the operator. Warn police and workers of the danger of cutting your poles.

Hopefully this will dissuade them from cutting. If they do try despite your warnings, you have a little bit better legal standing in the event they hurt themselves.



Store the poles near your blockading spot, strewn about to resemble regular fallen trees. Camouflage the poles with branches, leaves, etc... The sooner the tripod is used the less poles will weaken—either from rotting or drying out and becoming brittle.

# METAL TRIPODS

## PREPARATION TIME

Depends on where you get the poles. 30+ minutes to lash them together, 60+ minutes to dry run

## PEOPLE NEEDED

1 to sit, 8-10 to raise

## COST

Depends on where you get them. Scrap yard- \$50- \$75. Buying poles from fencing companies can work better than scaffolding since they have longer lengths and you won't need couplers to put the shorter poles together, but it will be expensive. Liberating scaffolding, poles from a swing set, fence poles, etc... is free.

*WARNING - Do not use threaded metal pipes that screw together. While practicing a tripod at the 2006 EF! Rendezvous made of these poles, one of them snapped at a joint, nearly injuring several people. The threading on the pole is a weak point that is too prone to breaking for them to be safe.*

## MATERIALS NEEDED

- **Three - poles 25'-40' long, and at least 1.5-2 .5" in diameter**
- **100' - rope for base support line around bottom of poles**
- **Two to five - bike tubes.**
- **45'-70' - 11 mm climbing rope (10'-15' for the knot, plus the length of the poles)**
- **One climb kit - (see *Climbing Basics*)**

## SITE SELECTION

Generally, metal tripods are for urban actions. Either scout out the area in front of the target building. Look for the narrowest part of the road nearest to your target, then pace out where you're going to set up so you know how wide of an area your tripod has to fill. Or if you're just out for some fun in downtown, get up early enough one day and see where the craziest morning rush hour traffic is—that's your intersection.

## POLE SELECTION

The poles should be steel, not PVC or aluminum—though some wild ass Floridians did make a bamboo one once; if you're going to experiment, do so before the action. And be careful. They should be at least 1.5" in diameter, bigger for longer poles—up to 2.5". Metal poles are ALL over the place; playgrounds, construction sites, fences are made of them. . . You can also buy them from a fencing or painting supply company, but the cheapest place is usually a scrap yard. If you use scaffolding, the poles are only 12' long so you'll need to stick 2 together with a coupler. It might be very tempting to put 3 together to get an even bigger tripod. DON'T. It will break.

If you're going to be on a slick surface, cut some bike tubing and tape it over the bottom end of the poles. This will give it a better grip on the ground while it's going up and keep the legs from slipping out when it's set up. Take any leftover bike tubes and thread them onto the climb line that you're lashing the poles together with. Slick poles and slippery rope don't make for the safest of situations; the bike tube will help the knot hold during set up.

## FOR BOTH WOOD AND METAL POLES:

### TIE THE KNOT

This is definitely the most confusing aspect of tripods, so read slowly, and then practice. The tripod knot is basically a series of turns that go around each of the poles. You'll need 6 turns on each pole. For practice, go get three sticks at least two feet long, two smaller sticks and a shoelace or something like it. Really, go now, come back when you have them and not before.

Lay out your practice sticks horizontally on the ground, and stack them in a pyramid—one on top, two on bottom. Prop the bottom two off the ground on one of the smaller sticks; the other goes in the middle—see **Figure 1**. From here

on out we'll call the sticks "poles." If you were sitting over the poles, facing the top of the poles, the bottom pole on your left is Pole 1, the top pole is Pole 2, and the bottom right is Pole 3. About 10 inches down from the top of Pole 1, tie a clove hitch—see **Knots** in the reference section. Make sure the longer end of the rope is heading into the middle of your

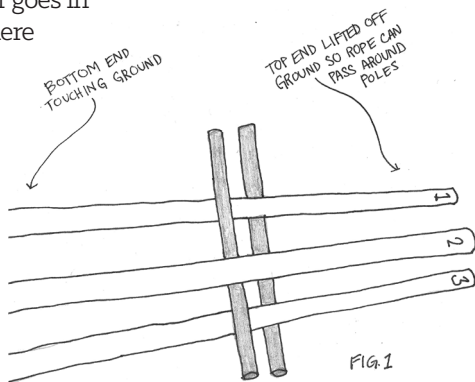

pyramid, not to the outside. Take the short end and tie a couple back up half hitches below the clove hitch.

The plan is to make a turn around Pole 2, then on Pole 3, then back to Pole 1. Around and around, a series of turns until there are 6 on each.

These directions start you off at the bottom of the knot, so you'll be working your way up to the top of the poles. Having a friend at the top of the poles to help pass the rope around the pole ends will stop you from having to pull the whole length of rope around each pole.

NOTE: THE INSTRUCTIONS IN THE TEXT ARE FROM THE POINT OF VIEW OF THE RIGGER SITTING ON TOP OF THE POLES. THESE IMAGES ARE DRAWN FROM LOOKING DOWN THE TOP OF THE POLES. DON'T FORGET THE PERSPECTIVE IS DIFFERENT WHEN YOU ARE READING IT VS. LOOKING AT THESE DIAGRAMS.

FIG. 2

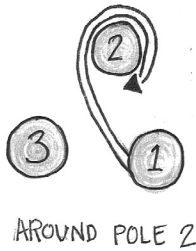

AROUND POLE 2

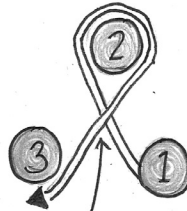

ROPE IS COMING AROUND POLE 3 FROM THE INSIDE OF THE THREE POLES.

Take the long end of the rope—called the working end—from the clove hitch and bring it under Pole 2, up the right side of it, across the top, down the left side, and down to the ground in the middle. As it goes under Pole 2, there should be an X with the rope coming from Pole 1. This pass around the pole is called a turn. If the rope didn't make an X, you just wrapped it in the wrong direction. To fix it, remove the rope from Pole 2 and wrap the other way around.

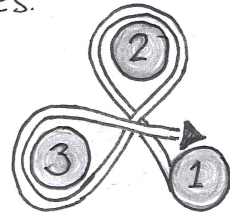

EACH TURN MAKES ANOTHER X

With the rope on the ground in the middle, pull it to the right underneath Pole 3 and up around the outside of Pole 3, back across the top of Pole 3 and head towards Pole 1. As the rope goes horizontally across the middle of the pyramid, it should make a second X as it crosses itself again, making another full turn. Now wrap it around Pole 1, starting across the top of it, down the left side, underneath, and back up the right side and

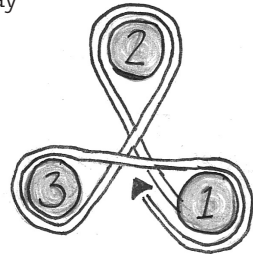

FIRST SET OF TURNS DONE!

into the middle of all three. As it comes up the right side of Pole 1, bring it all the way up past the right side of Pole 2—see **Figure 2**. Congratulations, you're done with the first set of turns. You should have something that looks similar to **Figure 3**. Now just repeat all those steps five times, making it so the turns are next to each other going up towards the top of the poles. Not terrible, right? Keep practicing and you'll get the hang of it. If not, check out **Monopods**, no lashing on that one!

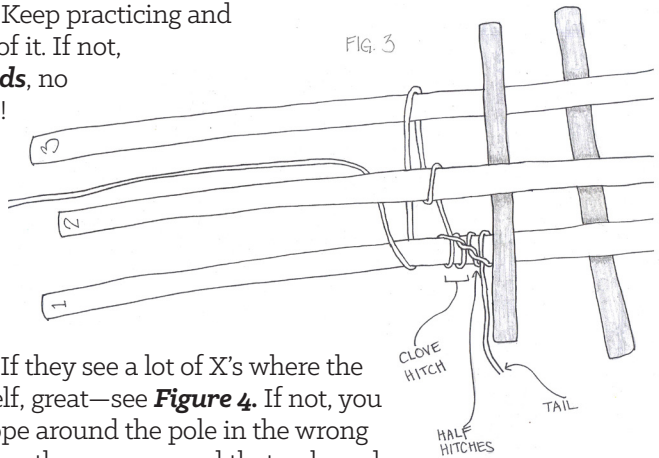

An easy way to check if what you're doing is right, is to have someone look down through the poles from the top. If they see a lot of X's where the rope is crossing itself, great—see **Figure 4**. If not, you just wrapped the rope around the pole in the wrong direction. Just go the other way around that pole and you've got it.

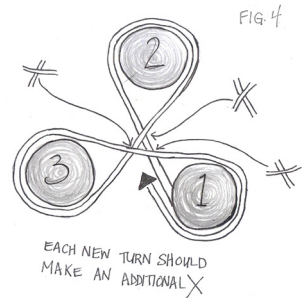

After you've made six sets of turns, it's time to finish the knot with a clove hitch and back up half hitches on Pole 1—see **Figure 5**. The long end of rope that's left is what your climber will climb up. It will also help you raise the tripod. Make sure you have enough rope. At a minimum, it should reach the bottom of the poles, but a bit longer will make raising it easier.

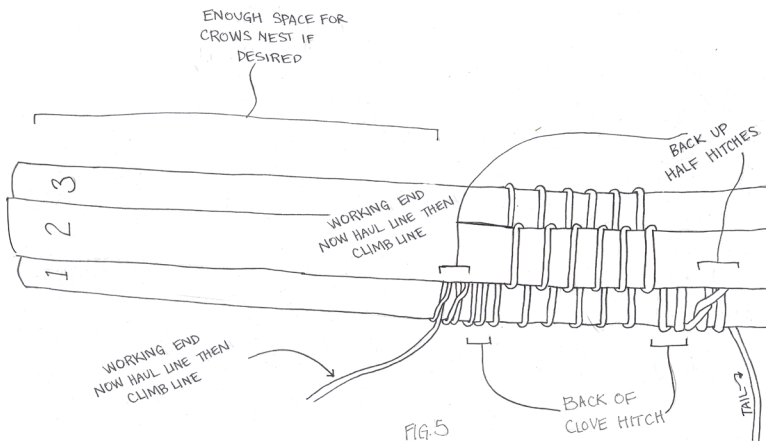



## TRIPOD HOT TIPS

>> When you tie the knot on the actual tripod, put a branch or log under Pole 1 and 3 to hold them off the ground. Put another under Pole 2 separating it from Poles 1 and 3. This makes passing the rope under and between them easier. When you're done, you have to take the middle branch out and tighten your knot down a bit. Push the slack out of the rope following the turns from bottom to top. Remember: too loose and it will slip and fall, too tight and it might not open up at all or might create too much tension and snap.

>> It can help to physically label the poles—either mark them with their numbers, or colored tape or rope.

>> The poles should be similar lengths, but if they're not exact, that's OK. If the action is going to be on flat ground, make sure the ends that are going to be the bottom are lined up evenly before lashing. If the action is on a slope, the uphill pole will need to be shorter so the tripod does not tip downhill. Tie the knot so that when it's done there will be about 3-4' above it at least. If you tie it too far down, your tripod is going to be sad and short; too high up and it will be hard to sit in the apex—if that's your plan.

>> Dry runs are the tripods best friend. Do a bunch. Go to some park, someone's backyard, or a clearing in the woods. Tie the knot and raise your tripod several times. When taking it down be extra careful and consider having more people. The two poles that the structure is pivoting back on can kick up into the air as it gets closer to horizontal—have folks ready to hold them down. Especially for heavier tripods, it's very hard to not have it drop the last 5-8 feet—this seriously threatens the integrity of your poles. Make sure to keep a good eye on the knot; as you raise and lower the tripod

it'll get slacker and start to slip. Once you've done it a couple times, you'll be able to get that thing up in a minute or so. Quick deployment is especially necessary in urban settings—like when your van just happens to stop in the middle of that busy intersection Monday morning, ya gotta put it up before you get forced out.

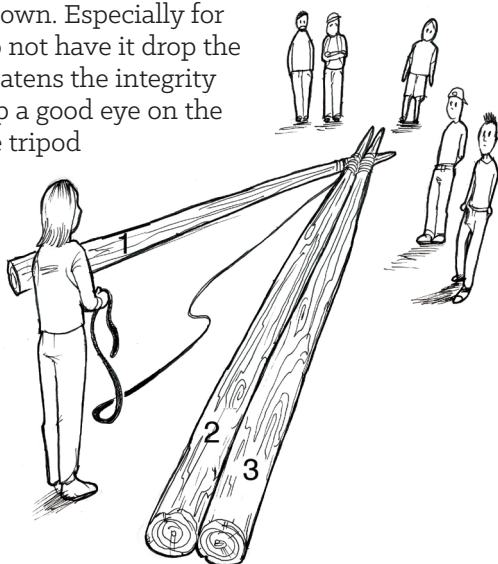

With enough practice folks can usually get the poles off the vehicle, set up, and the climber out of cop reach in 2-3 min. Can you beat the record?

>> If the tripod is going to be used on a smooth surface you will need to attach bicycle tubes, or tire tread to the feet of the poles. This will increase the friction of the feet on the cement and reduce the chance of the poles slipping under a climber's weight.

### RAISING THE TRIPOD

This is just one way to raise the tripod, there are several, but this way works for both light and heavier tripods with enough people.

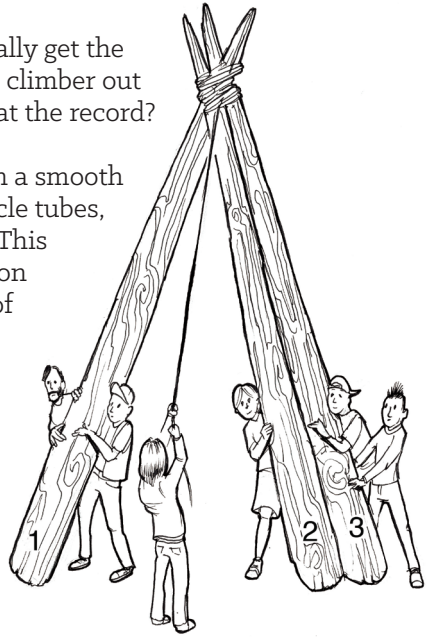

When moving or raising any pod structure, it is essential to have a “caller”—someone who tells everyone when to lift, pull, drop, etc...and keeps an overall eye open for the big picture and safety. This is a real group effort, and good communication is key. Having lookouts is helpful to make absolutely sure the coast is clear. After all this, the last thing that you want to happen is to have someone pull around the corner and catch you off guard. Everyone should have gloves and long sleeves to protect themselves from the sharp edges of the armoring. Use the webbing slings to carry the tripod onto the road. Lay the tripod down diagonally on the road. The poles should still be stacked in the pyramid shape they were lashed in. If not, roll them into this position and check to see that the lashing is snug.

Now, one person should mind the tripod at the apex—facing the bottom—while a couple folks drag Poles 2 and 3 to the right side of the road. The person at the apex needs to make sure that the tops of the two poles being moved end up on top of Pole 1. If you can, dig shallow, but solid holes in the road at the base of Poles 1 and 2. These will help the tripod stand up as you raise it, instead of just skidding

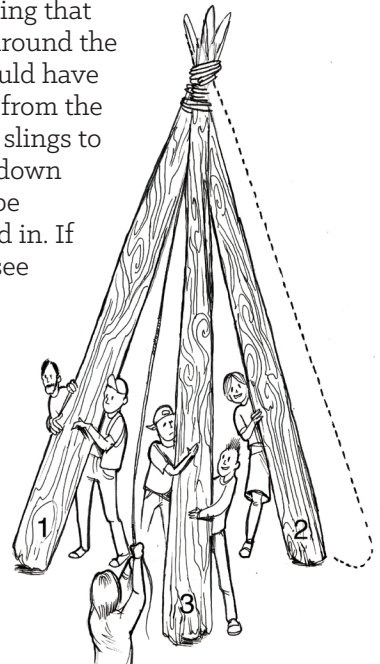

across the ground. If you can't dig holes, make sure you put some bike tire or tubes on the bottoms and then two people, preferable larger folks, will have to physically hold Poles 1 and 2 in place with their feet, as everyone else raises the tripod.

Numbers will change depending on the size and weight of the tripod; at minimum six people should get ready to lift the poles from up near the knot. You should form two lines, at least two people on the pole that's by itself, and at least four on the two poles lying together. Have people lined up from tallest to shortest with the tallest closest to the apex, that way everyone will be able to reach their part of the pole as it is lifted. If the tripod is bigger, plan to have more people to do all the heavy lifting. At least one person, should grab the climb line to help pull.

Everyone should be listening to the caller, and on the count of three, everyone at the apex begins lifting all their might. With the poles overhead, begin walking hand-over-hand toward the base to continue raising the tripod. Once the tripod is up a few feet, the folks with the rope can start pulling. If you pull too early, the force will skid the base of the poles on the ground instead of raising the top of the tripod. Force needs to be constant as the apex begins to rise. Move slowly and thoughtfully. The caller should be watching for problems and directing folks. Raise the tripod until it's almost standing upright, then stop momentarily.

This is the crucial point where Pole 3 will be swung into position. Be careful. Everyone has adrenaline blasting through their system at this time. If you raise the tripod too far, the whole thing will fall forward, KABOOM!

Two people—again, more if it's bigger—need to lift Pole 3 and carefully walk it to the middle of the road to allow the tripod to stand on its own. The pole may need to be jiggled a bit to free it from any obstructions with the other poles at the apex. As they begin walking the pole, the lashing at the apex will rapidly adjust and displace the tension being exerted on it. Everyone should have their attention focused on the lashing as it adjusts, watching to make sure nothing goes wrong. If the poles are weak or the lashing is tied too tightly, the poles could snap under the stress of swinging into position. Everyone should be prepared to dive out of the way if this happens.

The moment the pole begins to swing successfully toward the center of the road, everyone needs to gently resume pushing. The folks on the swinging pole follow the caller's directions to guide the tripod into place.

## **OPTIONAL FOR ONCE THE LEGS ARE IN PLACE**

Reinforce the rear leg holes, and dig and reinforce a hole for Pole 3. Next, you can tie the line around the bottom. Starting with one pole, tie a clove hitch at about knee height. Take the rope to the next and make a couple turns onto it at the same height, taking care to keep the rope taught. On to the next and then back to the first, finishing with a clove hitch. Make sure all of the turns are faced in such a way that they won't twist and add slack to the line.

This helps stop the tripod from doing the splits—if the rope is taught and at about the same height it will hold the legs together. It also prevents a vehicle from driving through—especially if this is followed up with barbed wire and other armoring. Some folks have made tripods that are big enough for a car or even a truck to drive under, using 60 foot poles! If the rope between two legs was pushed by a vehicle it would make the whole thing collapse. Make sure the cops hear this, and any aggro workers too! If you tie this and leave it on after the first couple practice runs it makes set up that much easier—all you have to do is swing the legs out until the rope is taught and you know it's where you want them.

## **CLIMB INTO POSITION**

The safest way into a tripod is to use climbing gear and have a knowledgeable climber prusik up the rope. As with all technical climbing, the person doing it must have an intimate knowledge of certain knots and devices that will keep them safe—see **Climbing**. The real advantage with this method is that if the climber slips, they are tied into the climb rope and will not fall. While it is possible to just shimmy up a pole, this method is not recommended. The armoring on the poles could create a painful beginning to the climb and someone falling on their way up is sure to be injured.

Once the climber has ascended the tripod, they should always have their harness on and have a point of safety attached to it. Although sitting in the apex will have the climber above their safety, it is sometimes necessary to gain those extra couple feet. Be careful and as safe as possible. It is also an option to hang below the apex. Make sure to bring up some strong fabric to make a hammock seat out of as hanging in a harness gets mighty uncomfortable after not too long.

## **THE FINISHING TOUCHES**

If it hasn't already been sent up, make sure the person who climbed up has something to sit on. A couch cushion or sleeping bag if they will be in the crows nest. Or something to make a hammock out of if they are hanging below—some rip-stop nylon, a sheet, etc...

Once the climber is safely seated in the tripod, you can run barbed wire around the perimeter, and up and down the legs. If this isn't enough to satisfy your hardcore blockade fantasies, the climber can lock their arms around the apex of the tripod with a black bear style lockbox—see **Ground Blockades**. This will prevent the tripod from being lowered without the climber's arms being ripped off. Be sure that this point is hammered home to anyone trying to disturb the tripod! The climber and support people need to firmly emphasize how fragile the device is and that any disturbance of the tripod could cause the climber to fall.

Whenever possible send a banner up with the sitter. Since the blockade is hopefully going to last quite some time, it's important for the climber to have a closure bag up with them. Fill it with their favorite goodies, some water, sunscreen, something for if it rains or is super sunny, a pee jug, a poo bucket etc..., whatever they need to help them stay up until forcibly removed or victory. It's also a good idea to have a cell phone, if it is a place with reception. Not only will it help them communicate with ground support, but if you're trying to get media for your action, an interview with the person in the tripod can help.



# >>> BIPODS

- + Very risky to dismantle
- + On-site storage
- Requires precise engineering
- Lengthy setup
- Is only defensible from one direction

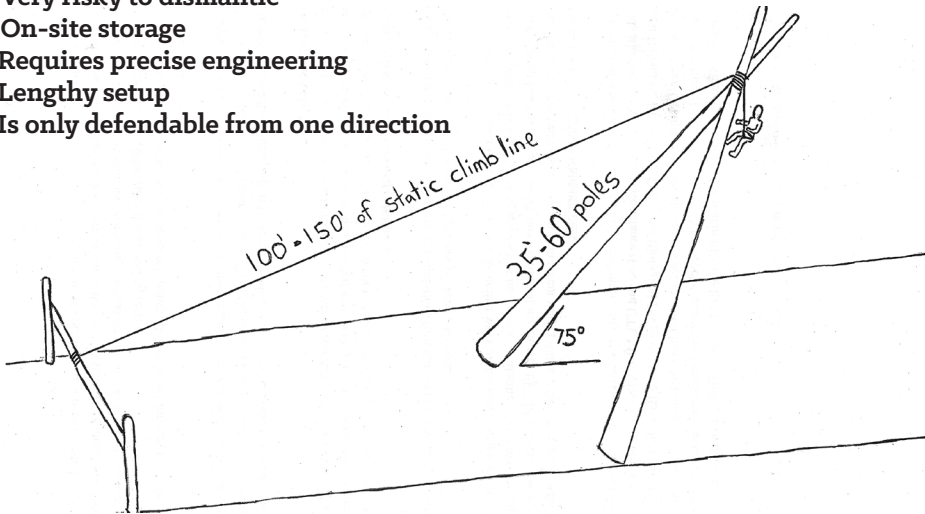

Bipods are another tool that can be used to block access to a road, door, or gated area. They are two poles held aloft by a support line that must be attached or anchored to something. They could be anchored to gates, cattle guards in roads, building entrances, bridges, any vehicle, or piece of heavy equipment. Another option is a dead man anchor—two lengths of heavy duty .5” rebar driven in an “X” at least 24” deep into a road, or longer if anchoring in softer soil.

Bipods can be difficult for law enforcement to remove because they cannot be cut down or drawn apart like an independent, free standing tripod. The support line of a bipod not only plays the crucial role of keeping the device aloft, it also acts as the blockade that prevents vehicle access. However, the anchor lines will only defend the bipod from the front. If vehicles can access the back of the bipod, they may be able to evict the sitter. While multiple support lines have been used, using a single line will simplify loads and not put any extra stress on the structure. Metal cables can also be used as support lines. These instructions are for rope anchors: if you are experienced with other materials, test them out with dry runs before deploying in an action.

Any interference with the support line, or the object that it is anchored to, will offset the precarious balance of the two poles and cause the whole thing to come crashing down. This needs to be made painfully clear to anyone attempting to interfere with a bipod. In addition, the structure



cannot be lowered, even if law enforcement ties off the lines. As the angle of the bipod with respect to the surface of the road decreases, the force on the support lines and the base of the poles increases dramatically and the structure becomes inherently unstable. When the angle between the legs and the ground decreases, there is a point at which the bottom of the legs will kick out, and the sitter will fall and likely be injured, or possibly killed.

Tasmanian activists have been throwing bipods up for years to block logging sites/timber sales and road building. Earth First!ers put up the first US bipod, “Bison,” at the Warner Creek blockade in Oregon in 1995, and a variation of it was erected on the Jack Squat free state in Idaho in 1996. More recently bipods have been used at The Buffalo Field Campaign in West Yellowstone and the Elliot State Forest in Oregon, among other places. While bipods have seen a fair amount of use since the mid-90’s, the process has yet to achieve a real standardization. This is one way to do it. There are many factors in safely and quickly deploying a bipod, so get your materials and crew together to do several dry runs.

**This is the most common way to rig a bipod. During the creation of this book, one bipod fell forward, towards its support line. We recommend that during your dry runs, your affinity group create the best way to tie a back support line—especially if there will be a banner on your structure—and get back to us with feedback about how you did it and how we can improve this book.**

## PREPARATION TIME

4-6 hours to gather and prep poles. 15 minutes to lash and assemble

## PEOPLE NEEDED

1 to sit, 6-8 to prep, and 8-12 to set up (depending on size and use of mechanical aid)

## COST

\$100-400 depending on how resourceful you are

## MATERIALS NEEDED

- Two – 35’-60’ poles
- One – Bow saw
- One – Axe
- One – 11mm climb line the length of your poles
- One – 11 mm static climb line, 100’-150’
- One – Climbing Kit (See *Climbing Basics*)
- One – Some type of platform, bosun’s chair, or hammock.



(See *Platforms and Treesits*)

- One – Come along/portable winch(optional)
- One – Pole 2/3rds length of others with a fork at the end for push pole (optional)

### SITE SELECTION

Follow the guidelines for *Tripods* on site selection, but also keep in mind that you will need an anchor point. Remember that bipods are far less effective in scenarios where vehicles are able to approach your blockade from behind.

### POLE SELECTION

Because the bipod is suspended at an angle, there is an incredible amount of force being exerted on the poles themselves. As there are too many species of trees both suitable and unsuitable to list here, look for a species that is both lightweight and not brittle. Species known to work well are Lodge Pole Pine, Tulip Poplar, Douglas Fir, and Hemlock. If you haven't already, this is a great time to become more familiar with the bioregion you're working in. If you're unsure, try to find an arborist that you could casually ask about specific tree characteristics. Diameter specifics vary greatly depending on species and desired height of your tripod. Approximations are dangerous to even guess at, but you are looking for poles that are about 1' in diameter at the base and 6" in diameter at the top, 35'-60' in length. Delimb and move them to your storage site as you would a tripod. They will be very heavy, and a pain in the neck to move. Consider using a come-along/portable winch and/or some small sticks as rollers where necessary. Otherwise, bite your lip, strap on your haul slings, and enjoy it. Just think of the expression on the cops' faces when they first see your creation in the morning.

### LASHING

The lashing weave you use on the bipod is not as complex as the tripod. First, lay the poles down side by side, placing a large branch underneath them about 5' from the top. Straddle the poles, facing toward the top ends. The pole on your left will be Pole A and the pole on your right will be Pole B. Take one end of your rope and tie a constrictor knot or clove hitch about 3' from the top of Pole A. Leave enough tail to tie a stopper knot or a couple of half hitches below the beginning of the lashing.

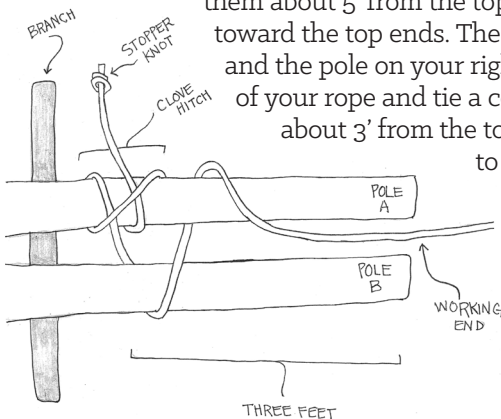

If the knot is tied too high, the sitter may have a harder time using a black bear

lockbox to lock down around the apex in the event of eviction. The long rope coming out of the knot should be on top, facing toward the middle. Take this end, now the working end, and pass it underneath Pole B, up around the outside of Pole B, and over the top of Pole B.

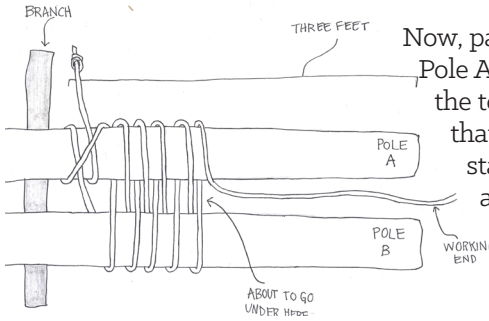

Now, pass the working end underneath Pole A, around its outside, and over the top. You should have something that looks like a figure 8. If not, start over until you get a figure 8 around both poles. Now, simply repeat the figure 8 five more times and part one of the lashing is done.

Once you have your figure 8s wrapped, the next step in lashing is to add some frapping. Frapping is simply a few turns around the lashing to help tighten things up. The working end of your rope should be between Poles A and B, pointing toward the ground. Pass the working end around the middle of the lashing three times, cinching it tight with each pass. Finish with a clove hitch on Pole A, just above the lashing, followed by two half hitches and dress the whole lashing by scrunching all the turns together and taking out any slack.

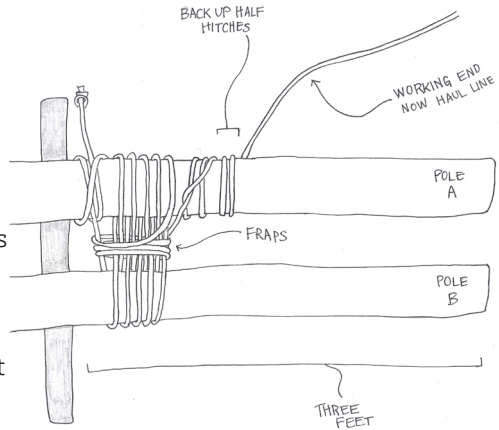

After you've finished the frapping and clove hitch, the remaining rope will first serve as the haul line, then become the support line. The clove hitch, along with the two half hitches around the pole, will ensure that the tension from the support line will not affect the lashing.

It can be helpful to have the final wraps taped or tied with accessory cord in place so that it is not disturbed while moving the bipod into place. The climb line will be shorter than your support line, so if you're running short on line, the remaining rope could instead be the climb line. If using the remaining rope for a climb line, you will need to set a separate anchor for your haul line. To anchor your haul line, take care that the rope exits the apex area on the inside of the pole, keeping the pulling force centered.

If you're attaching a separate climb line, use a High Strength Tie Off just above the lashing on the Pole B. If you've used the extra rope from the

lashing for the climb line, you still need a support/haul line. Use a piece of 1" tubular webbing and a locking carabiner to tie a Wrap 3 Pull 2 anchor just below the lashing. Tie a figure 8 on a bight on the end of your haul line and clip it into the anchor.

You may shave some time off deployment by choosing to attach a platform or bosun's chair above the lashing before the structure is raised. Your sitter could also choose to use a simple hammock tied between the ends of the poles. Coil the climb line and haul line and tape or tie them to the poles so that they are out of the way while moving the bipod into place, but can quickly be put into position for deployment.

### **RAISING THE BIPOD**

Maneuver the lashed poles and coiled ropes onto the road and spread the legs apart about a third the length of the poles—13 feet for 40 foot poles. Don't forget to have scouts in the area to make sure no one is coming. Dig two shallow holes to stabilize the bottom ends of the poles when you lift the bipod into position. If using a dead man anchor, drive the rebar stakes at least 24" into the middle of the road at a 45 degree angle with a sledge hammer. Make sure the anchor will effectively block vehicular passage when the support line is attached to them and that they are far enough away from the poles to keep cherry pickers at bay.

Four to six people will be needed to lift the poles from just below the lashing. Two to three of these people will be needed to lift each pole up over their heads and walk their hands down toward the bottom, lifting and walking as they go. At the bottom, three to six other people will be needed to pull the haul/support line, helping to lift the poles as the other people walk them up into position. The poles get lighter for the lifters the more vertical they get. As the poles become lighter and lifters begin to have a hard time reaching the poles, they can switch to helping pull on the rope. When hauling the line, no one should wrap the rope around their hands or wrists. If the caller told everyone to let go and one person's hand was wrapped in the rope, it could get ripped off. Stay safe. You may need a person at the foot of each pole to prevent the poles from sliding as well as to guide the poles into their respective holes.

An alternative to a team of pullers is to attach the haul line to a come-along that is attached to another anchor near the main anchor, and winch the bipod up into position. If a gate is being used, be sure it is locked with your lock, then attach the come-along to the gate and begin winching. Come-alongs require less effort, but people power is faster. In any case, people will be needed to at least lift the top end of the bipod up off the ground. With particularly tall bipods, it can be helpful to have a "push pole" that is used in helping get the bipod higher than the lifting team can

reach from the ground. Make sure your push pole has a fork in the end where the apex of the bipod can rest as it's being pushed up.

Before anyone lifts or pulls anything, it's important to have a designated "caller," just as in raising the tripod. The caller will direct the lifters to lift and the pullers to pull. As with the tripod, the pullers' force does not really help until the bipod is over a few feet off the ground. Move slowly and thoughtfully, with consistent force. As the bipod slowly comes up, the pullers will have more control of the weight—the push pole is needed if the lifters can't get the poles high enough for the pullers to take the weight. Lift it to approximately a 75 degree angle to the road, then stop. Not only does a bipod that is lower than 75 degree look kinda silly, it is easier to evict due to being shorter and puts more tension on the support line.

This is a crucial moment. The end of the support rope should be lined up over the anchors at this point, while the pullers are continuing to hold. Tie the support line to the anchor. If using a dead man anchor, tie four wraps around the intersection of rebar, followed by three half hitches. Reinforce the feet of the poles in their holes and pile rocks around them. Lengths of rebar can be counter sunk in the road around the base of the poles for added support. You can also tightly tie the bottoms of the poles to other anchor type things around, making it more confusing to dismantle the structure. Slash piles and barbed wire around the base of the bipod is also a good deterrent to folks that may disturb the structure.

### **CLIMB INTO POSITION**

Before climbing, one person should slowly put their weight onto the system. Sometimes things didn't go as you planned and there is more slack that gets pulled through, or your angle was wrong, or you are just acclimating the climber to the fact that they are about to ascend into a wicked bouncy structure. If everything looks good, the climber should first do the ABC safety check, then begin their ascent. If you haven't already attached a platform or bosun's chair, get ready to use the haul system you decided on to get things into place. After prusiking up to the lashing point, the climber can begin hauling up their platform or setting up their sheet hammock. If the climber is going to be ascending with a backpack, remember to try that in a dry run. It can be much more difficult than expected. Don't forget food, water, etc—see ***Treesits and Platform Rigging*** for a complete list. When all hauling is done, the climber should haul the climb rope up to prevent any unpleasant interactions from below. At no time should the climber unclip from their two points of safety on the climb line. Voila! Instant bipod blockade!

# >>> MONOPODS

- + **Extremely difficult to dismantle**
- + **Defendable from front and back**
- + **Quite the spectacle for the cameras**
- **Uses lots of rope**
- **Requires longer setup**
- **Complicated to setup and stabilize**

Tired of the same old tripod and bipod regimen? How about the monopod? The monopod is similar to the bipod in that the actual blockade is formed by the support lines. However, as the name suggests, this technique involves raising a single pole. While most bipods have one support line, the monopod requires a minimum of four. As always you can create more elaborate designs, but for this article we are sticking with four. When deployed on a road, the monopod is defendable from both the front and the back. As with the bipod, you can attach a platform or bosun's chair just below the support lines to make it a bit more cozy for the person staying up there. While it can be somewhat challenging to set up, a monopod can be extremely difficult for police to extract you from. Dismantling one is a particularly touchy and dangerous job. They also look cool as hell.

Setting up a monopod requires the use of many small teams, and good communication is extremely important. As with tripods and bipods, designate someone to be the caller, who will instruct the small teams to perform their tasks at certain times.

## **PREPARATION TIME**

4-6 hours to gather and prep pole. 20-60 minutes to rig and assemble

## **PEOPLE NEEDED**

1 to sit, 6-8 to prep, and 12-16 to set up (depending on size and use of mechanical aid)

## **COST**

\$100-400 depending on how resourceful you are

## MATERIALS NEEDED:

- One - 30'-50' tree
- One - Bow saw
- One - Axe
- One - 11 mm static climbing rope, 40' to 50'
- Two - 11mm climb line, 120'-150' minimum sections, depending on distance or anchor redirects
- One - Climb Kit - (see *Climbing Basics*)
- One - Fully rigged platform (see *Treesits and Platforms*) or a simple bosun's chair

## SITE SELECTION

Follow the guidelines from *Tripods* section regarding choke points. Also be on the lookout for anchor points. You'll need four, and it's best if they are each equal distances from the base of the monopod. In the example below we will use four trees, but get creative. In addition to blocking roads, monopods can be used to successfully occupy large work sites such as strip mines where work is generally required by law to stop when non-workers are present. In 2004, activists with Buffalo Field Campaign used a monopod to successfully occupy a corral used to trap wild buffalo, rendering the trap unusable. Anchor lines for monopods have been attached to closed gates as well as machinery to render them immobile.

## POLE SELECTION

Follow the guidelines from bipods but only pick one. You might want to go taller depending on site needs.

## RIGGING

It is best to know the approximate distances from the top of your monopod to its four anchor points ahead of time. Measuring from the base of the monopod to the anchors will give you a rough idea. If you wanna geek out on it, you can use the Pythagorean theorem,  $A^2 + B^2 = C^2$ , to determine the actual distance from the top of the monopod to the anchors. A is the height of the monopod from the base to where the support lines are attached, and B is the distance from base to anchor.

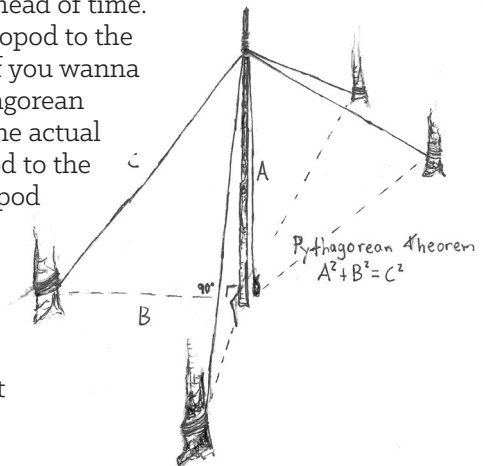

Don't like math? Just measure from the base to the anchor and add about 15-20 feet plus however much rope you will need for tying the anchor.

If you know one is going to be particularly farther than the rest, take that into account before doing the next step.

Provided your anchors are all about the same distance away, take your first support line and find the middle of it. This can best be done holding both ends of the length of rope in your hand and walking your arms up the length of doubled up rope until you reach the end, which should be a loop that's the exact middle. Once you have found the middle, tie a clove hitch or constrictor knot about 2' from the top of the pole. The ends leaving this knot will be two of your four support lines. Repeat this process, finding the middle of your second long rope and tying another clove hitch or constrictor knot on the pole, just above or below the first knot. At this point you should have four support lines of about equal length anchored to the top of your pole. The two pairs of support lines should be perpendicular to each other, forming an "X" if looked at from above. Note: If one of your support lines needs to be longer, simply move the clove hitch one way or the other, shrinking one side and elongating the other.

The climb line will also be used as a haul line. Use a High Strength Tie Off just below the support lines. Have the line leave the HSTO in the same direction that it is going to be pulled from so that the force of pulling it isn't trying to twist the pole as it's being raised.

### RAISING THE MONOPOD

Where the base of the monopod will stand, dig a hole about 6" deep that has a gentle slope on the side where the pole will lay before being raised. If setting up on pavement, particularly with an antenna version, place a rubber mat down to prevent slippage. The hole will keep the heavy pole from skidding forward. If you cannot dig a hole, consider tying the base

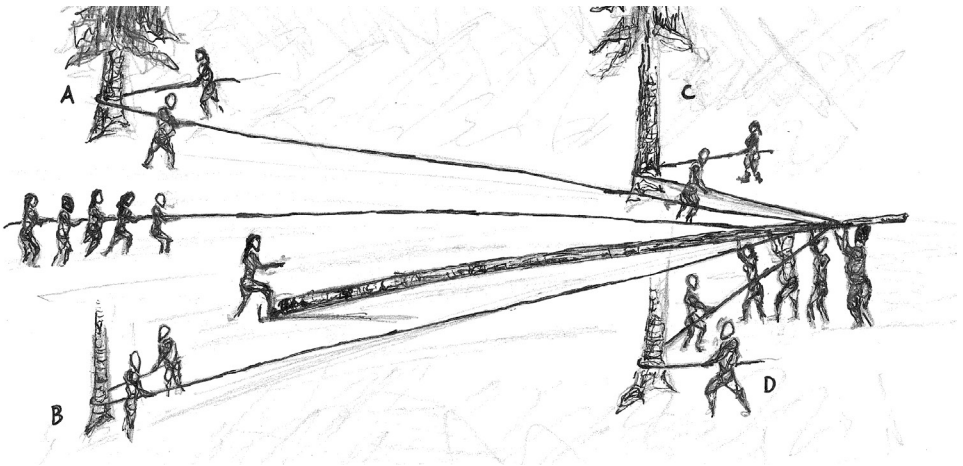



of the pole to a couple of anchor points to temporarily keep it from sliding forward during the raising process. Using the technique discussed in the tripods section, move the pole and ropes to the setup location in the road. Remember it is the job of the caller to determine when to lift, walk, spin, lower, etc.

## TEAMS

Assembling any of the structures in the blockades section requires teamwork and clear communication. Perhaps there is no clearer example of this than raising a monopod. Everyone should be divided into teams. There should be at minimum four, two person teams that are each responsible for a support line. The support line teams should each have a name. For this example we'll use A,B,C,D. Colors can be confusing if they don't correspond to rope colors, otherwise just pick something short that folks will remember. Also, try to not have huge differentiations in strength between members of the two person teams.

The support line teams will be further divided into one person that is responsible for tension and one person that is responsible for progress capture. This is done by wrapping the rope once around the anchor tree. Use more wraps if the tree is small. The friction from the wrap around the tree will make it easier to hold the rope in place, acting as a progress capture.

One person, the tensioner, will pull the rope. The other person, the captor, will pull the slack around the tree, allowing the tensioner to rest between pulling and letting out line. If the tensioner needs to let rope out, the captor person gives them slack. This progress capture buddy system, when done correctly, will also keep that heavy ass pole from falling on anyone.

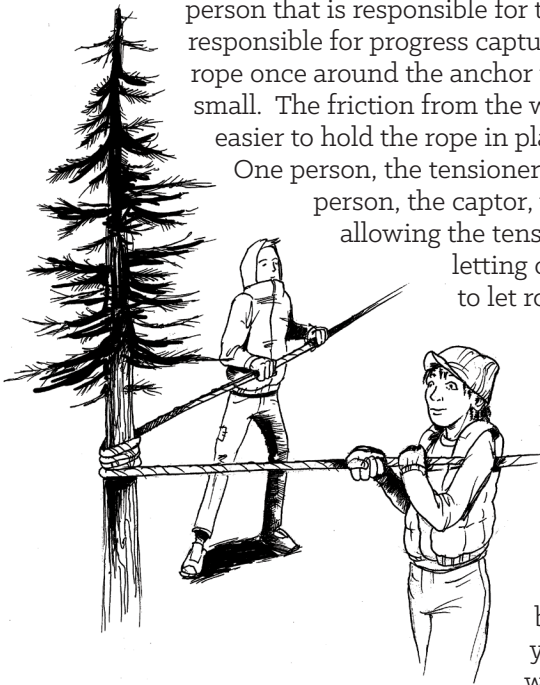

There needs to be a team of four to six people to pull the haul line; soon to be a climb line. As with bipods, if you are short on people, you could use a come along or winch to haul with. Lifting the top of the pole off the ground is the job of the last team, which should be

about four people. Once the pole is high enough that they can no longer push the pole up; they can join the team pulling on the haul line.

The support line teams should grab their lines from close to the anchor—the top of the pole—and walk toward the tree anchor they will be using, and then set up the progress capture around their tree anchor. The haul team should be at the very end of the haul line/climb line. When hauling the line, no one should wrap the rope around their hands or wrists. If the caller told everyone to let go and one person's hand was wrapped in the rope, it could get ripped off. Seriously, don't do it. The team that's lifting should be squatting with their hands on the pole just below the HSTO, ready to lift with their legs. When all teams are in place, the caller will have the lifters pick up the end of the pole and start walking towards the base of the pole, lifting it with their arms above their heads. As the pole gets a few feet off the ground, the team on the haul line should start pulling.



At first, the haulers will maintain constant pressure. The support line teams should be keeping a consistent tension on their lines. They need to listen to the caller in case they are pulling too hard or not enough to keep the pole raising correctly and as easily as possible. As the pole continues to rise, the top will pass the teams C and D. At this point, they need to slowly start letting line back out as Team A, Team B, and the haulers continue to pull. It's all a big balancing game and everyone needs to be paying attention. The caller may yell things like "Slack C" or "Pull A Pull B." The pole will get to a point that looks close to vertical. Here the caller can use a plumb bob or level to determine which lines need more tension and which need more slack.

Once the monopod is standing straight with equal tension on each support line, the support lines can be tied off. If using trees for anchors, take a few more wraps and finish with a HSTO. For other anchors—see **Anchoring**. Keep in mind that the current anchor point could be used as a redirect to something across the road, further blocking it. It is also possible, after someone climbs the monopod, to add additional lines that go in other directions to make it more difficult to dismantle. When redirecting anchors, check out Rope Strengths section to ensure you are doing this safely.

Now your climber is ready to ascend and get cozy. If you didn't have something for them to rest their bum on already attached, hurry up and tie it on the line so they can haul it up and settle in. Don't forget all the sitter's essential items for when the cops kick out all the ground support—see ***Treesits and Platform Rigging*** for a complete list.

### **ANTENNA**

A variation of the monopod that has proved useful in more urban settings, situations when the pod needs to be deployed quickly, or when minimal folks are available for setup, is to use a metal antenna truss structure instead of a pole. These are often found for free from folks who now have cable and don't use their old television/radio antennas at their house. They are lightweight and can be assembled in sections, making transport easier and requiring a couple less folks to set it up. If using the antenna method, you may only need two or three haulers and one or two lifters. Be sure to inspect them thoroughly for damage from rust or stress.



An antenna-style monopod was used to shut down a toxic frack-water storage complex in Ohio in 2013.

# >>> CANTILEVERS

- + Very difficult and dangerous to remove
- + Relatively simple to construct
- + Less common, so cops are unfamiliar with it
- Requires road with steep drop off and rising slope, or a bridge
- Difficult to support sitter
- Requires climbing skills and knowledge of knots and poles

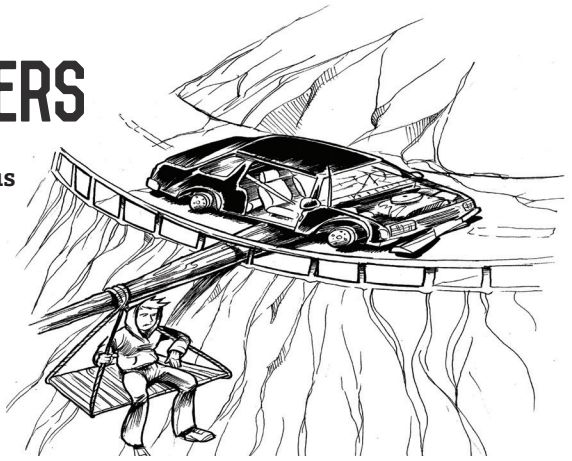

The Cantilever is an anchor dependent pole that is extended across a portion of road or bridge with the pole extending off into space. A person suspended on a platform or in a hammock occupies the end of the pole. Variations in the cantilever can be built using mini-bipods or barrels to elevate it to bumper level on the road. Additionally, a Batmobile (see **Batmobile**) can be dumped over the cantilever to weight it down and provide a more substantial blockade. Canadian forest defenders used this variation on Vancouver Island in 1993 defending the wild forests of Carmanah and the Walbran.

## PREPARATION TIME

3-5 hours to get pole, secure into roadside slope, and move into position.

## PEOPLE NEEDED

1 to sit, 6-10 to prep and set up.

## COST

\$150

## MATERIALS NEEDED:

- 25' to 35' pole
- One - bow saw
- One - axe
- One to two - hammers/mallets
- One - pair of bolt cutters
- 75 - 6" nails
- 30 - fence staples (optional)
- One - 2' to 8' length of chicken wire (optional)
- 35' - barbed wire (optional)

- One - ball of yarn (optional)
- Two - 10' lengths of 9-11mm static climb line to tie down base of pole
- Two - 3' lengths of heavy duty rebar to stake base of pole
- One - climb line for climber
- One - climbing harness
- Two - 5' to 6' lengths of 6mm perlon for prusiks
- Two - 5' to 6' lengths of webbing for leg loops and prusik extensions
- One - 18" to 2' length of 1" tubular webbing for climb rope anchor
- One - locking carabiners
- One - figure 8 descender
- One - rigged platform (optional)
- One - Climb Kit (see *Climb Training Orientation*)

### SITE SELECTION

The places that are calling out for a cantilever are bridges and roads that have a sharp drop off on one side and a steep slope uphill on the other. As with other blockades, make sure your spot is far enough away from the destruction you are blockading so that workers cannot just walk past your blockade and keep working. Measure out the width of the road/bridge to determine how long the pole needs to be.

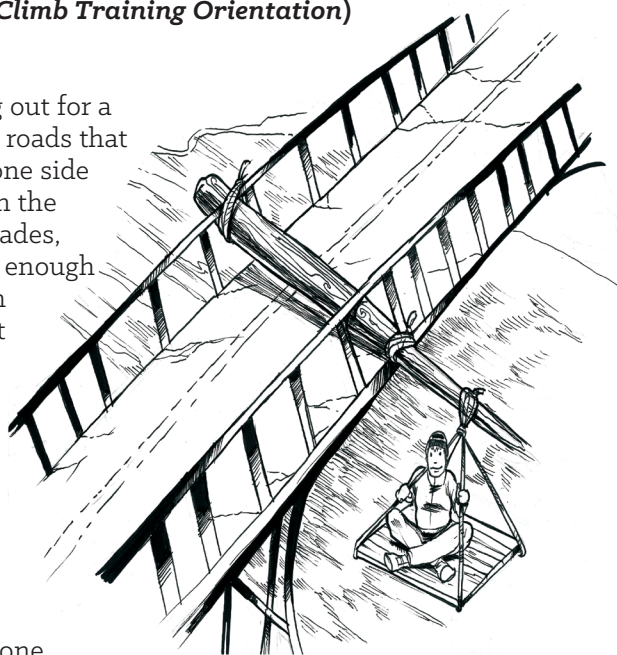

### POLES

Since cantilevers use just one pole, make sure your materials are strong. Find a strong, lightweight tree that is at least 6" to 8" in diameter at the top, and around 9" to 12" at the base. If you need to use a metal pole, be absolutely sure it is of adequate strength. Do not try to connect several shorter lengths of scaffolding, or use jointed metal poles that screw together—the pressure is too great and it can break. It'll be a sad and scary day if your metal cantilever either breaks with someone hanging off the end, or if it slowly bends down—either way the sitter is going to get dunked off. For pole length make sure you get something long enough to limit access by law enforcement.



If you are unable to find a tree with a large enough diameter to cut down, you can use a few thinner trees lashed together. Do not do this if you are not experienced with lashing. Delimb the pole and move it to your set up area. Just like with a tripod, armor the section of the pole that will be across the road. The armor will help prevent law enforcement from climbing on the structure to evict the sitter.

### TRANSPORT AND DEPLOYMENT

Move the armored pole to the blockade site, either with a vehicle if you are farther away, or carrying by hand with webbing slings—see **Tripods**. For a road blockade—rather than a bridge—have a couple folks start digging a hole in the steep slope that the butt end of the pole will fit in. At the same time the climber and others can begin anchoring their climb line and platform to pole. Using the webbing, tie a wrap 3 pull 2 anchor at the end of the pole and attach the climbing rope to it with a carabiner and a Figure 8 on a Bight. If you are using a platform, tie another wrap 3 pull 2 anchor with a carabiner to attach to the rigged platform—see **Treesits and Platforms**. If you are not using a platform this anchor can be used for a hammock, swing, or Bosun’s chair—having something to at least sit on will greatly increase the amount of time someone can hold down the blockade. Have the climber get as ready as they like to climb out, but do not clip to the pole until it is secure; just hold the climb line by hand during set up—if the pole were to fall while being swung into place, a person attached to the rope would be pulled right over the side too.

Once the hole is dug and the rope and platform are attached, have one person mind the rope while everyone else lines up along the pole. Now’s the fun time to just heave it around and across the road or bridge. Since it is longer than the road is wide as it swings out

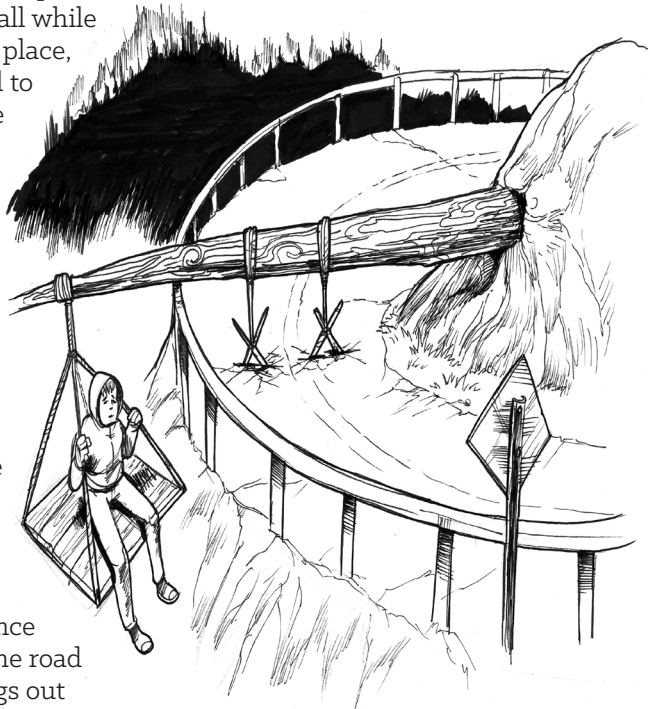

people will need to make sure to hold down the end so it doesn't tip off. *Don't drop the pole off the edge.* Wedge the end of the pole into the hole that you dug out. If you are on a bridge make sure to securely lash the pole to the bridge railings on each side.

On the road, install a Dead Man anchor—see **Anchoring, Rope Strengths, Physics, and other Technical Insights**—between the mid-point and the base of the pole. Use a short section of rope to tie the pole to the rebar. Test the strength right off the edge of the road before climbing out to the end.

### CLIMBING OUT

After making sure that the pole is secure, the climber can attach a Prusik system as if ascending a line, as well as use a lobster claw to prevent swinging in the event of a fall. The easiest way is to inch out on your butt and keep sliding the prusiks along as you go. Direct support is hard, so make sure the platform is well supplied with food, water, and other supplies—see **Treesits and Platform Rigging**.

Once the cops are on the way out, eviction can be complicated by climbing all around on the pole or up and down the rope. Beware of cops trying to attach ropes out near the climber to stabilize the cantilever before trying to move it. Cherry pickers and boom trucks can also become a nuisance. If the games are at an end, and if you are absolutely sure that the rope is long enough, the climber can attempt to repel down and get away. Make sure the rope is long enough. Having some knowledge of backwoods survival, and supplies for it are helpful. Knowing how to swim could come in handy with bridge blockades, or some timely friends in a boat.





# >>> SKYPODS

- + Don't have to move heavy poles
- + Can be defended from front and back
- + Often baffles law enforcement
- + Less people required for setup than a tripod, bipod, or monopod
- + Looks intimidating and technical
- Requires lots of rope/can be expensive
- Requires experienced riggers
- Requires lots of setup time
- A bit of math is needed—don't fear, we'll show you how
- Very site specific

Sky pods are essentially some form of platform suspended from a combination of traverse lines and support lines. Similar to a bipod or monopod, the lines that support the sky pod will be used to blockade your chosen area. The support lines of a sky pod generally run to something blocking the road; a gate, vehicle, or low level, self made traverse across the road. They generally require lots of rope and some experienced riggers to install, but can be very effective at keeping the machines at bay. Sky pods use two high traverses. One traverse will be used to hold up the platform and all the sitter's gear—food, water, etc.—and the other traverse will be your sitter's separate life support traverse and climb line anchor. *If the support lines on a sky pod are cut or tampered with, the platform—depending on the specifics of the rigging—will tip or fall to the ground. This needs to be thoroughly explained to any workers or law enforcement who may be on the scene. It's also recommend to mark any life lines close to the ground or lines easily accessed with signs that explain the dangerous nature of the lines.* Unlike other structures, you don't need to get a bunch of folks to carry some heavy poles around, which can really make a difference if you're working with less people, or hiking a long distance.

Sky Pods have been successfully deployed in Ohio, Oregon, and Pennsylvania to name a few places. There are infinite ways to configure them. They can have a single, heavy duty support line or many smaller support lines. A single support line can be easier to set up, but can only be defended from one side. Many support lines offer defense from many sides. For simplicity sake, we'll offer a couple of options, but focus on an example that uses two support lines anchored to a gate and a tree, blocking the road in both directions. Luckily, sky pods offer a lot of room for invention and creativity, so keep your affinity group brainstorming on how to adapt this general sky pod to more effectively fit your situation.

## PREPARATION TIME

4-12 hours. Newer riggers should be encouraged to step up to the task, but beware that even experienced riggers often need more time than they expect for this one. Make sure to do dry runs and give yourselves plenty of time.

## PEOPLE NEEDED

1 to sit, 2-6 to prep, 4-10 to hoist

## COST

\$300-1000 depending on how resourceful you are, what you anchor to and how many support lines you have.

## MATERIALS NEEDED

- **Two – 11mm static climb lines for the upper traverses**
- **One – 11 mm static climb line for the climb line**
- **Two – 7mm prusik cords for support lines –11mm if using single support line – sufficiently long to reach from the platform to the anchor point/s plus some extra length for knots**
- **Two – Rigging devices. Could be steel locking carabiners, shackles, or climb rated steel links.**
- **Four to six – 6mm or 7mm prusik cord slings—two for the climb line and two for the rigging hardware, some extra for progress captures, etc..**
- **Two – locking carabiners or screw links**
- **Two to three – Climbing Kits plus it's always nice to have extra slings and carabiners when rigging (see *Climb Training Orientation*)**
- **One – some type of platform or hammock and gear to rig it, lighter is better**
- **Any additional needs for the sitter (food, water, tarps, etc.) (see *Treesits and Platform Rigging*)**

## SET UP

### SCOUTING

Keeping in mind the ideas of choke points covered in **Tripod**. Two crucial elements to an effective sky pod are:

1. Trees, or something else tall and strong that won't get you electrocuted, high enough for useful anchors for an upper traverse. Keep reading for a better idea of proper height.
2. An effective way to anchor the support lines that will result in blocking whatever it is you are intending to blockade.

Refer to **Traverses** for specific information about setting traverses. For safety reasons, it's imperative that you read up on that shit, so don't skip it. As previously stated, it's very important to find trees that are tall enough. Since the upper traverses intentionally won't be taught, the platform will hang down considerably. Let's imagine we found some 100 foot tall beautiful white oaks and determined that we could put traverse lines 75 feet up them. Let's also say they are about 85' apart. If your traverse has the proper 120 degrees of sag, you will use about 100 feet of rope from tree to tree—not including anchor knots. The sag of a traverse that length puts the top of your platform about 25 feet lower than your 75 foot high traverse anchors. Add an approximate height of 5 feet or more for your platform and the bottom of you platform is a total of 30 feet below your traverse anchors, or 45 feet from the ground. This isn't even taking into account a few extra feet for any settling or stretching that anchor points and rope will have. While you don't need to know all these figures to set the sky pod up, it should give you a general idea that your traverse needs to be high. You should also understand that the further apart your anchors for your high traverse are, the lower your pod will be.

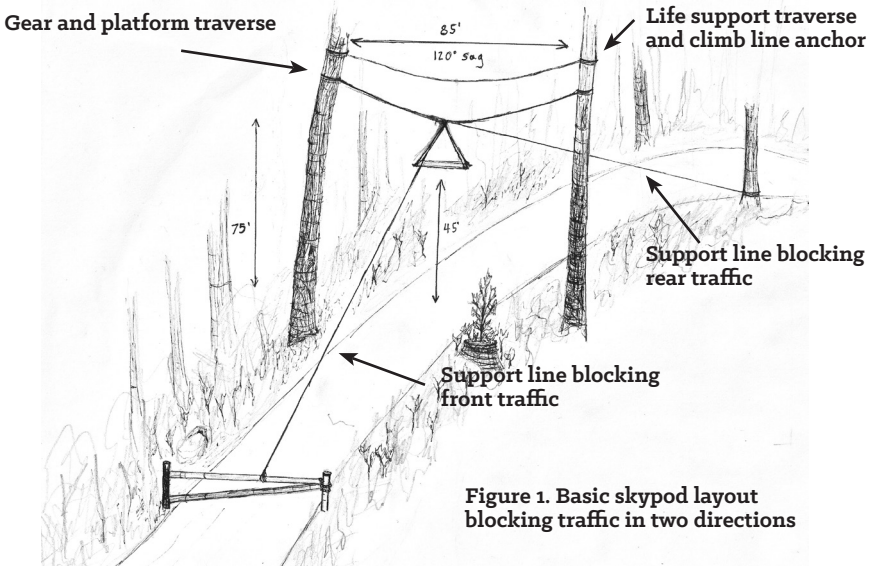

Figure 1. Basic sky pod layout blocking traffic in two directions

## ANCHORS

Choose your anchor points to effectively block access of a cherry picker to the pod. See **Aerial Blockade Eviction** for info on the range of a cherry picker. If you plan on using machinery as an anchor for your sky pod, keep in mind that it may change locations after being scouted. Since the objective is often to block a road. If you can't find a gate, it's not uncommon for sky pods to be anchored to low, self made traverse lines

that, once weighted, cross the road about 4 feet off the ground. If using low traverse lines to anchor your support lines, be sure to distribute the load well as there are many forces involved—see **Rope Physics**. Another anchor option is to use dead man anchors as described in **Bipods**. One affinity group of Earth First!ers in Ohio made their own “gate” across a road by lashing a large log horizontally across the road, then anchoring their support lines to the horizontal log.

Taking all these factors into account makes finding a strategic location for a sky pod more limiting than some other types of blockades.

### PREP WORK

Once you’ve picked your location, calculate the rope lengths you’ll need and have a bit extra. Build and rig your platform—see **Platforms and Treesits**. Your team should find a suitable place to practice and get some serious dry runs in. Use the dry runs to figure out how your ground team will communicate with the riggers in the trees. Will you use radios or just yell because you’re in unpopulated wilderness? If you will be working at night, think about where the moon cycle is and what the cloud cover and weather will be like to determine your lighting needs. To speed things up for rigging, you may want to send some climbers to get ropes in the trees ahead of time. If the road is mainly used by loggers, miners, drillers, etc. and the lines are well hidden on the backside of the trees, it should not be a problem to have them there early—try not to use that fancy blaze orange line you just got for hunting season though. If you are concerned that this is still too potentially noticeable, another option is to leave smaller black cordage or very high strength fishing line that you can use to quickly haul up climb lines on the day or night of the action.

You will also need to decide what rigging devices you will be using. The rigging device, which ever you chose, will redirect the support lines and hold up the pod. Folks have used steel locking carabiners, pulleys, steel rescue rings, and when in a pinch, both holes of a figure 8 descending

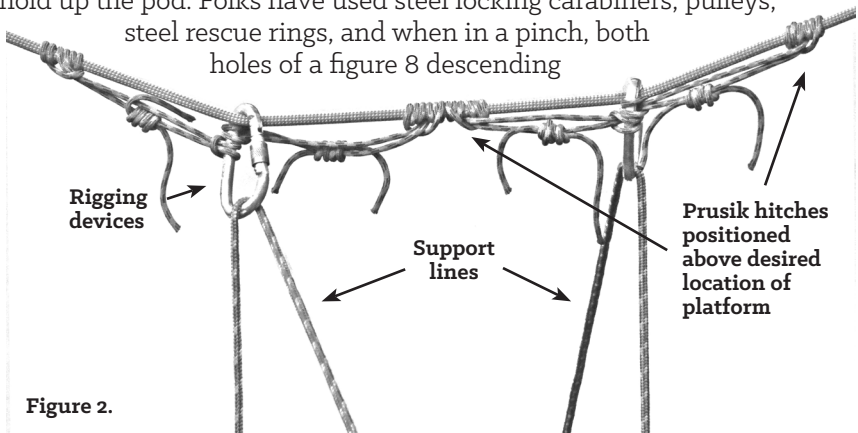

Figure 2.

device. Steel rescue rings are pretty nice, but not as easy to come by and costly.

## **SETTING THE HIGH TRAVERSES**

On action day, or night, send your riggers up the trees to install the high traverses. Each rigger should have a ground support person. While setting up the traverses, riggers may find it useful to use a small throw line with a weighted shotbag to get over and through webs of branches. When both riggers are at the desired height of the traverse anchors, which should be very close to the same height, Riggers 1 and 2 both throw a shotbag line to the ground; hopefully reaching outside the mess of branches right around and below each of them. A ground support person then removes the shotbags and ties the two lines together, and the two riggers can haul the shotline up until it is a straight line between them and free from branches. Rigger 1 can then attach the 11mm static line to the shotline, and Rigger 2 can pull it over. If your site magically has no branches in the way, each rigger can just haul an end of the 11mm static traverse lines up with them. If using a rigging device that can't clip onto the traverse, such as rescue links or figure 8's, they must be installed onto the 11mm static line before each HSTO anchor is set. After Rigger 2 pulls over the 11mm static line, each rigger can pull the traverse hand tight, then each tie a HSTO anchor. Once the first is installed, repeat the process for the second traverse, anchoring about 3 feet higher and not adding rigging hardware to the traverse.

Once both traverse lines have been installed, it's time for one of the riggers to position the rigging devices in the center of the lower traverse. The rigger should use a pulley to connect themselves to the top traverse. Use prusik slings to tie prusik hitches onto the traverse on both sides of your rigging hardware. Use these prusik hitches to position the rigging devices above the desired location of the platform. The rigging devices should be close to one another on the traverse line.

Next, a climb line needs to be installed on the upper traverse. The rigger can lower their shot line to the ground. A ground support person should tie on the climb line and the rigger can pull it up. Attach the climb line to the upper traverse by tying an eight on a bight to the end of the climb line and clip it onto the upper traverse with a locking carabiner. Tie a prusik hitch with a prusik sling then clip the climb line carabiner into the sling. The climb line can now be set a few feet away from the rigging hardware to keep it clear of the platform.. To increase comfort, the rigger may want to transfer to the climb line at this time.

## ON THE GROUND

While the riggers have been goofing around in the trees for some time, the ground team should be communicating with scouts to be aware of if anyone is coming. Also, they should have the platform rigged with support lines ready to be hauled up. Label the support lines “front” and “back” or “left and right” as appropriate or necessary. Just be sure to agree on what the orientation is. If you’re setting traverses, dead man anchors, or building some other anchor, it is best to have them in place before hauling the platform. If folks on the ground have free time, they can also begin setting up slash piles to further delay a police response.

## ALL TOGETHER NOW

Now that the traverses are complete, it’s time to get this thing in the air. At this point, the platform should be fully rigged with the supports of the platform attached to the support lines. The ends of the support lines can be labeled in regard to their destination, or you may be lucky enough to have acquired different color ropes—in this case “Gate” and “Tree.” Ground support should tie the support lines onto the climb line. Then, the rigger that is still waiting patiently in the middle of the traverse pulls up the support lines. Someone on the ground will be the “wrangler,” keeping the support lines from getting twisted as they get hauled up. The rigger will run the “gate” line through one rigging device and the “tree” line through the other.

Next, the rigger passes the lines back down to the ground crew. The ground crew untangles the lines. The rigger may choose to install a progress capture on the support lines, just below the rigging device. This will prevent the platform from falling if the ground support were to accidentally drop the support lines when hauling them up. Ground support then walks the support lines back to their respective anchors. This often works best in teams of two. As the support lines are being walked back, the platform is raising, with the rigger minding the progress capture. The rigger will tell folks when to stop pulling—when the platform has been raised until it reaches the height of your rigging gear, then the ground crew will be able to tie off to their anchors.

After the support lines are set, the rigger should move around in the platform and see if any adjustments need to be made. This is a critical point. The platform must be more than high enough off of the ground because sometimes it sinks more when all the gear is attached to the platform. Once the platform is declared totally awesome, swap out the rigger for the sitter and their necessary gear ASAP—see **Platforms and Treesits** for a list of supplies to consider. Then you should all high five on pulling off something totally bad-ass.

Once on the ground, the riggers should remove all gear unessential to the sky pod and take it to a safe spot that the cops won't find. The ground crew should put lots of bright flagging on any support lines. Slash piles in front of any support lines will also protect them from vehicles driving into them. Put up signs that tell people not to mess with the ropes. It's also not a good idea to have people walking under the platform, as things may accidentally fall from there. It may be wise to have a police liaison inform the police that it's unsafe to hang around under the platform.

If you haven't already, it's time to start planning the next stages of defense. Maybe a tripod would look real nice 150 feet down the road?

## **VARIATIONS/ADDITIONS**

>> Add a single stabilizer line that supports the platform from above. If law enforcement tries to lower the support lines, the stabilizer will cause one side of the platform to stay high, thus creating a "dunker platform" that will drop the sitter. Be sure to explain this to any law enforcement. Additionally, it will stop your pod from spinning.

>> Anchor the support lines on the ground and tension them using a progress capture near the rigging devices before hauling the platform. Use a separate haul system to raise the platform to the pre-tensioned support lines. This method has the advantage of creating anchor points that are not accessible from the ground and pre-tensioning the support lines can reduce the amount of adjustments needed to account for slack and stretching of support lines. This can be especially helpful when using a ground level traverse line to anchor the support lines to since these have large amounts of stretch/sag.

>> If the sky pod is intended to be up for a long time, you may want to consider installing treesits on the trees that the upper traverse lines will be anchored to so that the anchors are better defended. Most likely law enforcement will issue a closure to the area and having buddies in the trees can also make it much less lonely out there, helping blockades to last longer.



# >>> AERIAL BLOCKADE EVICTIONS

**NOTE:** This section covers eviction techniques specific to aerial blockades. See *Police Intimidation and Torture Tactics for other dirty tricks the cops use to break up all types of protests.*

Sadly, even the most beautiful of blockades usually gets evicted eventually. While this has not always been the case, and will not always hold true, it's best to be as prepared as possible when setting up any aerial blockade. There are some moves that cops make almost every time—like moving the support people away so that the climber is as isolated as possible. Some of their tactics can be easy to plan countermeasures for—like having more than one climber or a good means of communication so that isolation does not become an issue. As these blockade tactics are gaining popularity, the police response is becoming more nuanced as well. Depending on the structure built, the eviction is going to be different. Below are some extraction methods that have been seen over the years.

## LIFT TRUCKS

The most common method of evicting aerial blockades is an articulated boom lift, a cherry picker, but blockades can be set up to make cherry picker eviction nearly impossible. Cherry pickers come in many models with different maximum heights. At the time of this writing, the tallest lifts reached a height of 150 ft. That being said, the more important measurement is horizontal reach. The same machine that reaches 150 ft vertically can only reach 80 ft horizontally. When designing a bipod, monopod, skypod, or any device that relies on ropes to keep machines at bay, do some homework and try to find out what machines are available at local equipment rental stores. Do not overlook the fire department either—give them a call to find out the reach of their ladder trucks. This information can help with the planning stages to know what lengths of rope and poles are needed to thwart the eviction efforts.



Police use a cherry picker to evict a tripod in Australia

If they are able to reach the sitter, it becomes decision time. Is it time to comply and willingly get into the bucket and then detach from the safety line? What are the merits and strategy behind buying some more time with a U-lock or lockbox? If the plan is to safely climb higher than the truck can reach, are there adequate supplies also out of reach? Cops will frequently cut away an abandoned platform, supply buckets, even the end of climb lines if the climber scampers away to avoid arrest—don't get stranded in a tree with no supplies and no way to get down!

## **SCAFFOLDING**

While much less common than intimidation and cherry pickers, scaffolding is just about impossible to defend against. Cops can walk the pieces into position and just build it up under the climber until they are standing eye to eye. Like with cherry pickers, it is decision time again—comply and unclip, or lock onto something and force them to bring a cut team up the scaffolding.

## **CLIMBERS**

If the sitter is unreachable by other methods, rescue climbers or deputized arborists have been sent up trees after people. These skilled climbers will climb right up to the platform, forcibly clip the sitter to their own harness, cut them free, and then lower them to the pile of cops waiting at the bottom. When deciding how best to greet climbers sent up into the pod, keep in mind that if they have been deputized, fighting back could turn into pretty serious charges.

## **TRIPODS**

There are a few eviction techniques that are special to tripods, and do not work on other devices. Police have been known to get a couple extra beefy cops to pick up one pole a little bit, have another cut a foot off of the pole, then move onto the next pole. Slowly but surely, the pod is lowered to the ground. Another beefy cop move is to have several cops pick up each leg and slowly walk apart. This method puts a lot of stress on the knot and tops of the poles. Make this abundantly clear if they start attempting this eviction method. If they try this anyway, it is almost guaranteed that at some point the cops will not be able to hold the poles anymore and the tripod will collapse when the poles slip out from under it.

Be as prepared as possible to spot the lies, armor the poles, have a good police liaison, and maybe bring up a lockbox or U-lock. If all else fails, check out **Poo Person** or use your magic wand.

# >>> TREE ENTRY

Once you have found an awesome spot to install a treesit or aerial blockade, one of the first tasks will be getting into the tree. This is generally accomplished in one of two ways (however, there are many others.) Girthing is the slow and steady approach to accessing the canopy of the forest, while throwing a line is often the quicker and occasionally curse ridden method. While climbing trees varies with species and bioregion, a variation of one/both of these two methods is almost always necessary before any climb lines can be set.

## **GIRTHING**

Girthing uses a prusik system that is attached to moveable girth tails that secure the climber to the tree. As the climber ascends, the girth tails are slowly inch-wormed upwards one by one. Girthing is not appropriate for trees with loose, flaky bark, such as a shagbark hickory. Also, it's great to scout trees in the day time to avoid poison ivy or oak. You wouldn't want to end up with a nickname like Puss Face after having a nighttime encounter with some thick poison ivy vines.

## **MATERIALS NEEDED**

- **Two to three - Sections of 11mm Climb Line – about 10 feet longer than the circumference of the base of the tree**
  - **One - 11mm Climb Line – length should be twice the highest point that will be climbed**
  - **Six - Locking carabiners – 3 should be steel**
  - **One - harness**
  - **Four - Prusik slings**
  - **One - Webbing sling**
  - **One - Descent device**
1. Tie a figure eight on a bight on the end of each of your short sections of climb line and clip a steel locking carabiner onto the bight. These are now girth tails.
  2. It's very important to use steel carabiners here, as they are less brittle than aluminum and tolerate being tossed around quite a bit more. Fling the end of the girth tail around the tree, catching it on the other side. If you have a large tree, try this: give yourself 3 feet or so of rope and swing the rope around the tree, allowing your carabiner to hit the tree. As soon as your carabiner taps the tree, swing the rope around the other direction, allowing about a foot of rope to slide through your hand, lengthening the rope you are swinging. Continue this process, keeping your momentum going, until you have enough rope to reach all the way around the tree. The whole

process is kinda like fly fishing if you can picture that. Treesitter slang for this is “tapping.”

3. Once the rope is around the tree clip it back onto itself, slide it up to eye level, and cinch it back up against the tree so it stays in place. Make sure the gate of the carabiner is facing you, not up against the tree. Tie a figure 8 or other stopper knot at the bottom of the tail that is hanging down. This will be your lead girth tail.
4. Repeat steps 2 and 3 with your second girth tail, setting it about a foot below the first. This will be your foot girth tail. One difference is that the girth tails should wrap around the tree in opposite directions. If your first girth tail went around the tree clockwise, your second should go counterclockwise. Having the girth tails pass around the tree in opposite directions will help to prevent “corkscrewing” around the tree as you ascend.
5. Tie a sling to the section of the lead girth tail that is hanging down with a prusik hitch. A shorter sling is usually preferred. Clip this into the center carabiner on the bridge of your harness. This will be your lead ascender.
6. Tie a sling to the foot girth tail with a prusik hitch. To the sling that is prusiked to the foot girth tail, attach a webbing foot sling with a girth hitch. Use one last sling girthed to the sling that is attached to the foot girth tail to be used as a safety. Clip this into the left carabiner on the bridge of your harness—if you’re right handed. This will be your foot ascender.
7. Go over your ABC safety check—see **Basic Climbing**. Remember to take a climb line up with you if you don’t want to girth down.
8. After your safety check, stand on your tip toes and slide the lead girth tail up as high as it will go and cinch it down. Sit in your harness, putting your weight onto the lead girth tail.
9. Raise the foot girth tail to slightly below the lead girth tail. Slide the foot ascender as high as you will comfortably be able to reach with your foot.
10. Step up in the foot ascender.
11. Slide the lead girth tail up, then transfer your weight to it.
12. Repeat Steps 9 -11 until you reach your goal or the first branch. *Be sure to check your carabiners frequently as sliding girth tails up a tree can cause locking carabiners to unscrew.*

If you reach a branch that you need to get over, fling your extra girth tail around the tree trunk, above the branch. Attach a sling to the girth tail and clip it into the third empty carabiner on the bridge of your harness. You can then move the other girth tails above the branch and remove one when they’ve all made it over. Don’t forget to go over the ABC’s before transferring safeties.

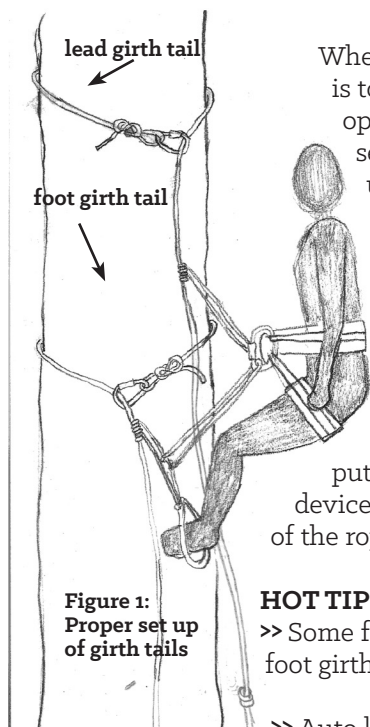

**Figure 1:**  
Proper set up  
of girth tails

When you're ready to come down, one option is to slowly girth your way down, just the opposite of the way you came up. If you're not setting a more permanent line that you can use to descend, you can set up a temporary one. Find a solid crotch in the tree or a healthy branch at least 5-6 inches in diameter—beware on conifers and weaker hardwoods—and drape the climb line over it. Tie both ends together with a figure 8 on a bite and lower it to the ground. This way will ensure you have a stopper knot. Follow midline descent protocols, but put both lengths of rope through your descent device. When you're on the ground, untie the ends of the rope and pull it down.

### **HOT TIPS**

>> Some folks prefer a full length climb line for their foot girth tail, then they use it for their descent.

>> Auto locking carabiners are great for girth tails

>> Retired climb line can be a great candidate for girth tails if the bad sections are cut out

### **THROWING A LINE**

Throwing a line into a tree generally involves heaving a weighted object that has a thin line attached to it over a branch or crotch in a tree. The thin line is then tied onto a climb or haul line and pulled over the branch or through the crotch. A shot bag and shot line are what arborists typically use for branches that are 70ft high and under. It takes some serious practice to heave a shot bag over a branch that high, so go ahead and find a good place to practice before relying on this technique in the woods. If you feel a branch is out of your range, you may consider adapting the following for use with a crossbow, large slingshot, or Big Shot—an arborist slingshot capable of 100-150 foot shots. Folks using crossbows often use monofilament fishing line, 20lb test or more, but be sure to clean up any broken fishing line. It's very hazardous to everything in the forest and gets tangled very easily.

You may encounter unexpected falling debris as you fling your weight into the branches, so a helmet is really a good idea. It could be part of your awesome lost mountain biker disguise as well. Don't forget the spandex!

Many folks have had success using anything from heavy bolts, retired carabiners, and rocks. However, having a throw bag, whether you buy one or make your own, can be really helpful for accuracy and not getting caught in a tight crotch or branch. They usually weigh between 8 – 14 oz., with heavier ones being used for thicker line. Line that is specifically designed to be throw line can also be helpful as it is lightweight, slick to slide over branches, and does not tangle as easily as some other cordage.

Another helpful thing is a good container to store your throw line. In between uses, throw line should be “flaked” into the bag, bucket, or fancy folding cube. Flaking is basically stuffing the line into the container, starting at one end and continually feeding it onto itself. Take care that sticks or knots don’t make it into the bag. When done properly, the line should exit the container without tangling and not change the course of your shot bag after you heave it. Either tie one end of the shot line to the container or use a shot bag on both ends. This will prevent all of the shot line from flying away in the event things get a little out of control.

Choosing your target branch or crotch can be a bit tricky. Different tree species also play a key role in determining what is an acceptable target. Always choose a live branch. If you’re dealing with lots of conifers that grow straight up with somewhat brittle branching, make sure you don’t choose the lowest branch. In the event of a branch breaking, have at least three live backup branches below it. Be sure that the target branch or crotch does not form a sharp “V” shape that risks getting the throw bag or rope stuck when you pull it over. Also take into consideration what other branching may be in the way of your target. You may choose to aim for a higher target that has a more clear shot.

Folks generally use one of two distinct styles for throwing a shot bag, the Sling Style and the Granny Style. The Sling Style can be used with any homemade shot bag and the Granny Style requires a shot bag where the shot line attaches to a ring. The Sling Style is a take off of the sling that young Palestinians commonly use to hurl rocks at Israeli tanks. With your shot line properly flaked in it’s container or laid out in an area free of sticks, grab the line a couple feet from the shot bag with your throwing hand. Give it a few spins to get some momentum, then let go as the shot bag it the general direction of your target. This will take practice.

Some say the The Granny Style is easier to be accurate with. It starts by passing a bight of line through the ring on your shot bag, then pulling it until you have a loop about 2 feet long in one hand. The other hand will hold a single strand of line about two feet from the shot bag. The shot bag should be hanging at the bottom of a “V” that is formed by the shot line being held by both of your hands. Square your shoulders to

the target and stand with your knees bent and your feet shoulder width apart. Look at your target and gently swing the shot bag between your legs. When you're ready, swing the shot bag forward quickly with your hands headed straight toward the target. When your arms are not quite fully extended, let go of both sections of throw line. Once you've gotten your aim dialed in, start adding a jump with your legs when you launch the shot bag to get some extra height.

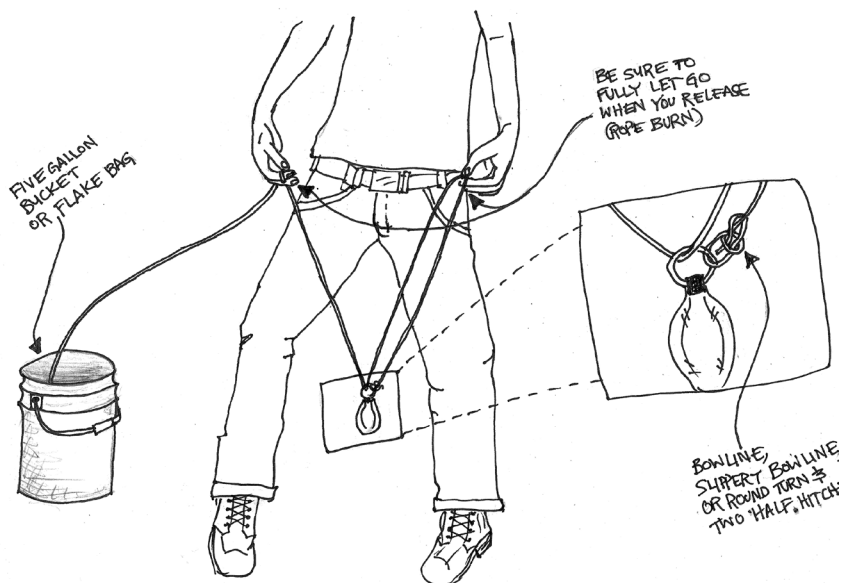

If the target is missed, take care when pulling the shot line back. If you do it too quickly, the shot bag may flip all the way around the branch, securing the shot line to the branch. Some folks just take the shot bag off if they are hauling the line back through the branches.

Once you have assessed that the shot line is over the target branch—binoculars can be handy for long shots—it's time to get the shot line following a path straight downward. This is important because when the climb line gets installed, all of the weight of a climber must be on the anchor branch or crotch, not some other branch 20 feet from the trunk. To clean things up, gently pull the shot bag up and over any additional branching. When it is clear of additional branching, allow the shot bag to slowly come toward the ground. If you need to redirect the end of the shot line that is coming out of your container, attach the shot bag to the other end and pull it up and over any necessary branches.

With the shot line correctly in place, it's time to attach the climb line. Start by tying the throw line to the climb line with a clove hitch about 3 feet from



one end of the climb line. Traveling toward the end of the climb line, tie a series of half hitches, finishing with one about an inch from the end. This will help get the climb line through the crotch of the tree. Start pulling the throw line up. If you're having trouble when the climb line gets to the crotch, try pulling in a quick and snappy fashion. If the throw line is hurting your hands when you pull on it, wrap it around a stick and pull with that. Once your rope is over the crotch or branch, carefully weight both ends of the rope to test the strength of the branch. Pay attention to make sure the rope is only over the target branch. If everything is in place, anchor using a High Strength Tie Off—see **Anchoring, Rope Strengths, Physics, and other Technical Insights**—or simply climb a double line.

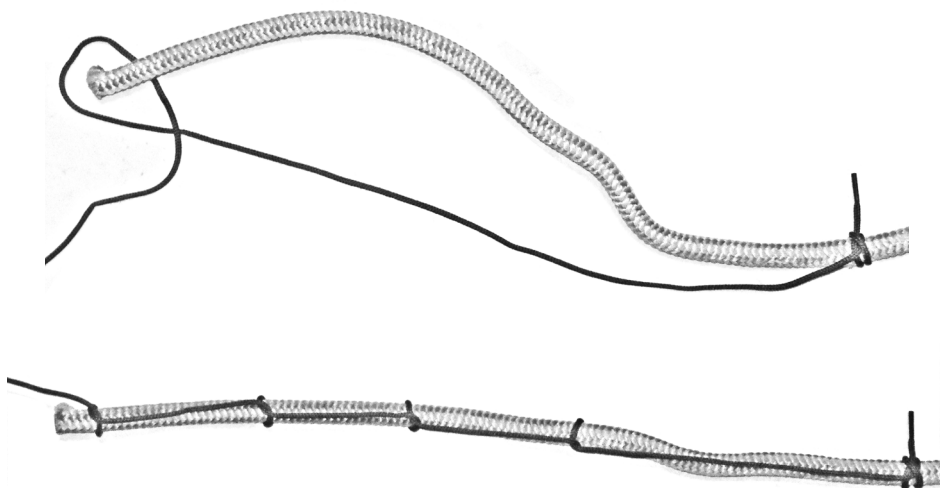

How to attach a throw line to a climb line

# >>> TREESITS + PLATFORM RIGGING

So you have someone who is down to occupy a platform? That's great! We will assume that you have already evaluated strategic considerations of whether or not this is a good idea for your campaign and that you have some understanding of how you intend the action to go down.

## MATERIALS NEEDED

This list does not cover everything, and will obviously change depending on the format of your action, platform design, etc., but go over this list before you throw some poor person into the woods with nothing but a piece of plywood and a desire to protect the wild. Remember that it takes a lot of effort to get items up and down from a platform and that everything you bring out may be confiscated, covered in mold, or otherwise not make it back. Also remember that many campaigns run on shoe-string budgets and that despite everyone doing their best, you might not have everything on this list.



- **Platform**—More on this below
- **Anchors**—See **Anchors**.
- **2 large screw links**—Rated for 3300 lb or locking carabiners for platform and climb line.
- **Climb line**—For the sit—reaches to the ground with knots on both ends.
- **Haul system**—Can be ½" truck rope or climb line with a pulley, carabiner, and webbing to anchor the pulley. Make sure the haul line fits through your pulley. Also bring a small sling for tying a progress-capture prusik. If your climber knows compound haul systems, consider extra pulleys and short slings for a haul system with more mechanical advantage. The length of the haul line should be double the distance from the ground to the platform anchor.
- **100 ft tubular webbing**—Used for tying platform stabilizer, additional anchors.
- **Sitter's climbing gear**—Harness; 3-5 locking carabiners; slings—lead sling, foot sling, foot safety and a few extra, figure 8 or ATC descending device; glove for rappelling; lobster claws—webbing or climb line with carabiners that can be used to safety around a branch when not able to

safely use main climb line. Optional gear may include helmet and a shot bag with 150' of accessory cord.

- **Tarps**—That are larger than the dimensions of the platform—camo is best.
- **Five gallon waste bucket with lid**—Toilet paper. 1 gallon urine jugs. Consider using dirt or duff to mix with your detritus to keep down smell/flies.
- **Trash bags**—Small ones for trash and large contractor bags for keeping gear like sleeping bags dry.
- **Food buckets**—Or bags filled with cans and other nonperishable such as just-add-water foods. Don't just leave your person with corn, give them good nourishing food.
- **Full water jugs**—1 gallon jugs are best; large 5 gallon “cubies” are difficult to haul without haul systems that have a mechanical advantage. Bear in mind you should be drinking a gallon of water a day, in addition to food prep, hygiene, etc.
- **Cordage**—50' minimum. 550 parachute cord is ideal. Most objects must be tied off with a lanyard to avoid dropping them.
- **Carabiners**—4-5 for attaching gear. Non-locking, not necessarily climb rated but burly enough to hold heavy items.
- **Lockbox**—Including jewelry for locking down. Only have this if you're confident it will be used, the sitter has been trained and there is ample support.
- **Cellphone**—With a way to charge it. It is best if the phone can take & send photos. Alternately have a separate camera that could go out with ground support. Cheap phones have interchangeable batteries that last for days. Remember solar chargers only work in certain climates and times of the year.
- **Phone list**—Of all important media, ground support and local allies. Be sure allies have your number as well. Verizon often seems to have good coverage in the backwoods.
- **Can opener, knife, mess kit, first aid kit, head lamp, and spare batteries**—Stuff you would bring camping.
- **Bike tube, duct tape, lighter**—These are essential for making clean cuts in rope but are useful for many things.
- **Pen, pencil, paper**—For writing stealth notes to ground support or writing one's manifesto. If you're in a super wet climate, you may consider some of that waterproof paper.
- **Personal gear**—Treesitter should bring items deemed “necessary to survive.” Sleeping bag, change of warm dry clothes in a garbage bag, gloves, etc. Wool is an excellent choice for clothes because they insulate when wet, while cotton just makes you colder. If you're really planning on being there a while, think about those items that will make a stay comfortable—binoculars, books, sewing kit, crafts, toothbrush, candles, etc.

## PLATFORM DESIGN

There are plenty of platform designs out there, but we'll focus on two basic models: the Bosun's Chair and the Cascadian Cadillac. These designs should provide a basic framework for platform construction. Feel free to experiment and modify these designs and develop your own style. It can be easiest to construct the platforms at a house, shop, or cabin, but plenty of folks have improvised and built sound structures while in the woods.

When choosing plywood, know that there is a difference between plywood and OSB or particle board. OSB looks like a mosaic of little rectangles of wood and plywood is made with distinct layers of veneer — thin slices of wood. Plywood is lighter, stiffer, and handles moisture much better.

Don't forget to add a layer of protection between the tree and the platform. This could be denim, firehose, burlap, etc. Also, it's important to add a horizontal rope that will act as a stabilizer, keeping the platform from swinging, and adding more friction between it and the tree. As with everything climbing related, it's way better to ask questions when someone's life may be on the line than to bullshit your way through scenarios. There is no right way to make a platform, only infinite ways to do it wrong.

## THE BOSUN'S CHAIR

+ **lightweight and simple**

+ **cheap**

- **not good for long occupations**

- **minimal space for storing gear or keeping you out of the weather**

The Bosun's Chair is a tool that was developed by sailors for working aloft and has been adopted by window washers and construction folks. In its most basic form, it's a wooden plank suspended by ropes. The user sits on the plank, which is more comfortable than sitting in a harness for extended periods of time. They are simple and cheap, but not so good for extended occupations. These are commonly seen on monopods and bipods.

## MATERIALS NEEDED

- 1 board about 2"x10"x30"
- 24' 11mm climb line, 1" tubular webbing or ½" truck rope
- 1 locking carabiner or screw link
- Power Drill
- ¾" Paddle Bit

## TO ASSEMBLE

This is a basic model that has a board supported by two lengths of rope. We also suggest running a rope across the backside to add some back support for the sitter. When using the Bosun's Chair, be sure to stay safetied into a climb line or safety anchor.

1. Drill four holes, one at each corner of the board. Keep the holes at least an inch from the edge of the board. Sand or file the holes to reduce friction.
2. Cut a section of climb line about 12' long. Thread the rope through the holes on one end of the board.
3. Tie a double fisherman's knot with both ends of the rope—or a water knot if using webbing.
4. Repeat steps 2 and 3 to form the other support loop.
5. Gather the support loops and clip them together with a carabiner. Clip the carabiner into a temporary anchor, then adjust the loop lengths and board position to level the board and make sure there is enough room for someone to sit comfortably. The support loops should be tensioned equally.

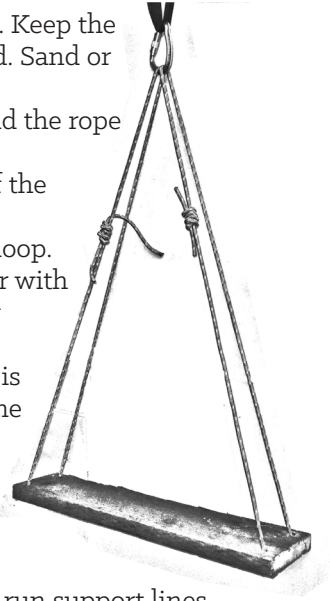

## VARIATIONS

- Create adjustable legs for each corner.
- Use some extra rope to make a backrest.
- Add a second board above the sitters head and run support lines through it. This will make more room for the sitter by having the support lines form a square instead of a triangle. There are lots of ways to do it, so play around and submit your findings to the *Earth First! Journal*. The downside of this is that the whole system will hang down lower, but it also gives some better tarping options for when the rains come.
- In some situations, folks have found using a hammock or turning a sheet into a hammock to be comfortable for a few days. This can work really well with tripods, bipods, or from tree branches near a treesit. Remember to always stay safetied in.

# CASCADIAN CADILLAC

- + big and comfy
- + good for long term occupations
- heavy
- requires lumber

## MATERIALS:

- One - Sheet of 4'x8' Plywood ( 1/2 inch thickness)
- Four - 2"X4"X8' pieces of lumber
- Six - 10' lengths of truck rope or climb line
- Six - 10' lengths 6mm prusik cord tied into slings
- Power drill
- 1 inch paddle bit
- One - wood saw
- 3" wood screws
- 1" wood screws

This is the most common platform design. It's designed to fit well in a pickup truck bed, against a tree trunk, or on the capitol lawn. These are strong sturdy frames that mirror the construction of your average wall in a house. They are annoying to transport on the ground, likely needing at least three people, and are difficult to maneuver aerially.

## ASSEMBLY

1. Find a flat spot, maybe on top of that nice big piece of plywood you got, and build a rectangle with the 2X4's that measures 48"x96." This is efficiently done by leaving two of your 8' 2X4's full length, and cutting one of them into two 45" sections. To add rigidity to the platform, assemble the rectangle making sure that 2X4's are laying so that the 4" dimension is vertical. Screw the box together at the corners, driving 2 or 3 screws through the 8' foot sections into the 45" sections.

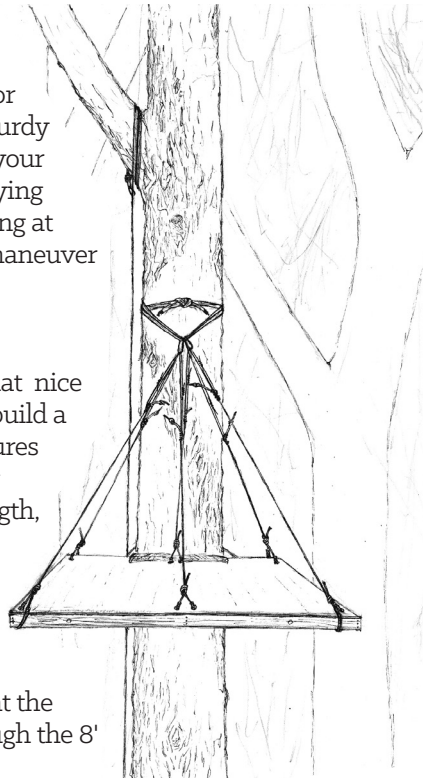

2. Cut one more 45" section for an added support in the middle.
3. Place the plywood on top of the box you built and line up the edges with the box. Screw the plywood down using the shorter wood screws about every 8."

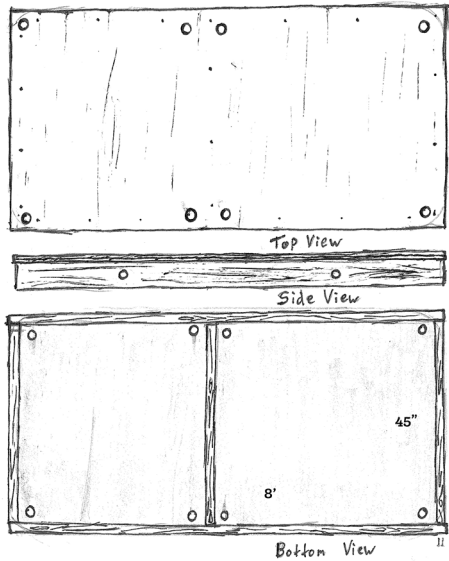

4. Once the plywood is screwed down, flip it back over and add your middle support by screwing it to the 8' 2X4. Flip it back over and screw the plywood to the middle support.

5. Now you're ready to drill holes for your support lines and stabilizer lines. Check the above diagram for hole locations. Holes should be drilled on the inside of the 2x4s, so that the support lines will be able to wrap around the 2x4, allowing it to take most of the platform weight. Sand the edges of the holes to reduce friction. You may choose to add a few extra holes for tying on gear once the sitter is in the tree. Some eager Earth First!ers that have lots of time on their hands and no electricity have been know to drill these holes with a leatherman tool.
6. If you have time, give that thing a nice paint job on the underside with the awesome, radical slogan of your choosing.

## VARIATIONS

- Cut out a wedge where it sits against the tree to add stability. Don't forget to adjust the size or shape of your 2x4 frame if you do this.
- Use multiple platforms to construct a "donut" sit that goes around the entire tree. This is more defendable and should be considered if the cops are known to send up climbers to cut down supplies or platforms.
- The Appalachian Sketchball involves eliminating the 2x4 frame to have a lightweight but flimsy platform. It's used for short term occupations where access is difficult. It is essential to get plywood thicker than 1/2" for this application.
- Simply use a hammock or sheet for short term occupations.



# GROUND RIGGING OF PLATFORMS

There are many ways to rig a platform. Your methods may be influenced by the materials you have on hand and the weight of the platform. Here is one way.

## MATERIALS NEEDED

- **Rope protection:** you need to put this around the platform legs in the holes where it will rub against the plywood. Garden hose is ideal, but bike tube, tubular webbing or cotton clothing can be used as well.
- **Two - steel links or locking carabiners:** used to attach platform legs to the anchors.
- **Six - 10' lengths of 11mm climb line.** These become the 'platform legs' that support your platform.
- **Six - 10' lengths 6mm prusik cord tied into slings.**
- **One - Marker for labeling**

## CONSTRUCTION

1. Pick which side will be oriented against the trunk. Label it with sharpie.
2. It can be helpful to start by tying a temporary anchor about 6 feet off the ground. Move the platform to a relatively level position under the temporary anchor. This will help you estimate the lengths of each leg to achieve a level platform in the tree.
3. Tie a follow through figure eight with each piece of 11mm line, passing the rope through the support holes before finishing the follow through figure 8. Don't forget the garden hose for rope protection.
4. Tie a figure 8 or barrel knot at the other end of each piece of climb line.
5. Attach a 6mm sling to each piece of climb line using a prusik hitch, which completes each support.
6. Clip the support legs into the temporary anchor. Use one carabiner or screw link for 3 support lines and another carabiner or screw link for the other three.
7. Use the prusik hitches to adjust the support leg lengths until the platform is a couple inches off the ground and level.
8. If the design or installation is new to you, you may want to

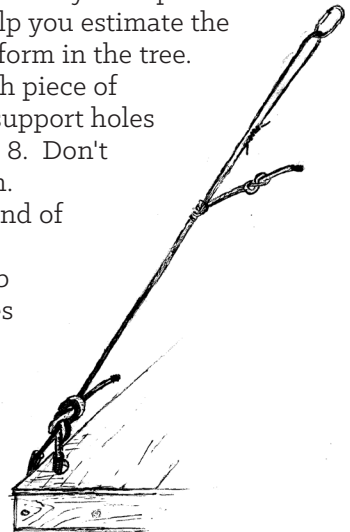

experiment with adding horizontal stabilizers with webbing, climb line, or truck rope.

9. Go ahead and lie down in it and imagine how homey it will be with a nice camo tarp over it.

## VARIATIONS

- Some folks have been known to use ½" truck rope for support legs, but 11mm static line is easier to work with, stronger, and lasts longer
- Some folks design platforms to use 2 or more anchors. This allows the support legs to attach in different locations with the intention of creating more living space

## UP RIGGING/ RAISING PLATFORMS

Platforms can be set with minimal people if a mechanical advantage is applied. However it is common for two people to be rigging in the tree and for multiple people to be working on the ground, helping to haul. If you plan on having multiple riggers, ensure that they each have lobster claws or a girth hitch climbing system so that they are not sharing a climb line for safety. Make a plan that everyone feels comfortable with.

## MATERIALS NEEDED FOR SETTING PLATFORM ANCHOR

- **Personal climbing gear.**
- **Extra prusik slings.**
- **Haul system consisting of pulley, anchor for pulley, locking carabiner, and a sling for progress capture. Use more pulleys and anchors if you will be using a compound hauling system.**
- **Platform Anchor—length of webbing and a steel link or locking carabiner**
- **Sitter Safety Anchor—length of webbing and a steel link or locking carabiner.**
- **Haul Anchor—length of webbing and a steel link or locking carabiner**
- **Hauling line—needs to be about 10 feet longer than twice the distance from the ground to the upper platform anchor if using ground support to haul the platform.**
- **Chafe protection to limit friction between the tree and platform.**
- **A bit of food and water helps if things go a little longer than planned.**

## CONSTRUCTION

1. Figure out the height you want the platform. Tie a wrap-3-pull-2 anchor about 6 feet above that height. This is your platform anchor.
2. Tie another wrap-3-pull-2 anchor at least 5 feet higher than the platform anchor. This is your haul anchor and it needs to be high

enough that if the platform is raised vertically, it will be easy for the rigger to attach the legs to the permanent anchors.

3. Attach the haul line with a pulley and carabiner to the haul anchor.
4. If using ground support for hauling, tie both ends of the haul line together and send them down to the ground.
5. If the riggers will haul from the tree using a compound hauling system, send one end down to the ground riggers, then install any extra pulleys and progress captures for your haul system.
6. Connect the haul line to two platform legs at the end of your platform. This will allow your platform to ascend in a vertical position, hopefully avoiding as many branches as possible. Use a 6mm sling with a prusik hitch tied around both legs. Clip this sling to the haul line.
7. In the tree, if a progress capture has not already been installed, use a 6mm sling to tie a prusik hitch to the working end of the haul line that is attached to the platform legs. Clip this sling into the carabiner holding the pulley. Now if folks let go of the haul line, the prusik will catch, preventing the platform from crashing to the ground.
8. Start hauling. As the line is pulled down by the haulers, the platform will be raised. If you tied a progress capture, someone will need to be minding it unless you have a prusik minding pulley. Be aware of how the platform is oriented. Make sure the trunk side is facing the tree trunk. It is very difficult to rotate a platform 180 degrees while in the air.
9. When the platform legs are level with the platform anchor, start attaching the legs into the anchor. Once all the legs are attached, the haulers should slack the haul line to allow the weight of the platform to transfer from the haul line to the platform anchor.
10. Once the platform weight is on the platform anchor, the haul line can be detached and the support legs adjusted until the platform is level. While leveling, riggers should not have any weight on the platform itself.
11. With a level platform, the riggers can now attach a stabilizer around the trunk and through the pre-drilled holes in the platform. Add any chafe protection between the platform and tree. Tighten the stabilizer lines to snug up the platform and prevent any swinging. Securing stabilizers below the platform, in the opposite directions of the support lines, will make the platform much less moveable.
12. Almost done. Once the platform is level and stabilized, tie an additional wrap-3-pull-2 anchor around the trunk above the platform but below the platform anchor. The sitter can use this as a safety connection while in the platform.
13. After any other gear and supplies for the sitter have been raised to the platform, don't forget to uninstall your haul system. You'll want that gear for your next bout of mischief.

## VARIATIONS

- Some folks use a truckers hitch system for their support lines. This system uses more rope, but some find using it easier to adjust heavy platforms.
- If you have a particularly branchy tree, you may consider attaching another line, which does not have to be climb line, to the bottom of the platform. It can be used as a tag line when the platform is being raised. When the platform comes to a branch, the haulers stop hauling until the folks with the tag line pull the platform out of the way, then the haulers continue pulling.
- Raising a platform can be loud and tedious. If it is a hot situation, it is best to send up a sitter and their gear first.
- It may be necessary to clear a path up the side of the trunk that the platform will be ascending. Don't be squeamish, the tree likely understands. This is easier to accomplish during the ascent of the climber, rather than having them descend when the platform gets caught. If you expect to remove branches with a saw, check out some pruning guidelines to make the proper cuts for tree health.
- Don't stand beneath the platform if you are on the ground hauling. It's not uncommon for branches to fall down.
- It is really handy when first adjusting platform legs to have a few extra prusiks to hold support lines in place.

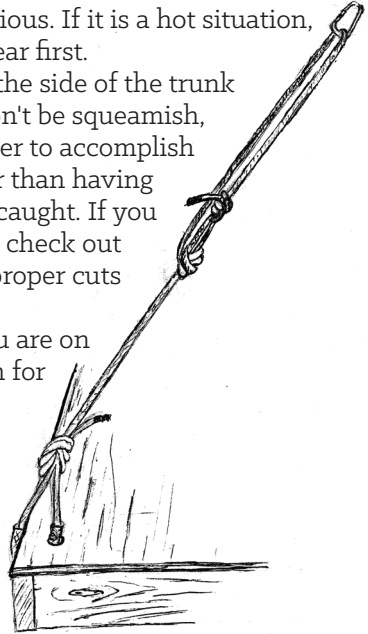

# >>> RIGGING TRAVERSES + INTERNETS

The most important thing to keep in mind about traverses is angles. They can exponentially increase the weight applied to a traverse. For a more in-depth discussion on the physics of rope refer to the resources section of this book found online.

Assume a traverse is so tight that when a 150 pound person is in the middle of it, the angle of the traverse at the nadir, or lowest point, is 170 degrees. That 150 pound person is creating a load of 17,250 pounds at each anchor point! There is no way without some serious mechanical advantage to create a traverse that tight, but keep in mind the physics.

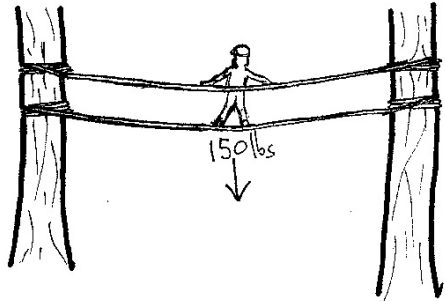

**DANGER!** A 150 pound person is generating 17,250 pounds of pressure on each anchor point if this were to be a 170 degree angle.

There is a big trade-off between ease of crossing a traverse and safety factors. The tighter the traverse is, the easier it is to cross but the greater the forces that are generated. Not only do you have the weight of the climber to worry about with a tight traverse, you also have the swaying of the trees to consider. A tight traverse will essentially be shock loaded every time the two trees attached to it blow in different directions.

To address this issue several solutions have come about, from simply ignoring the physics and creating tight traverses to having prusik

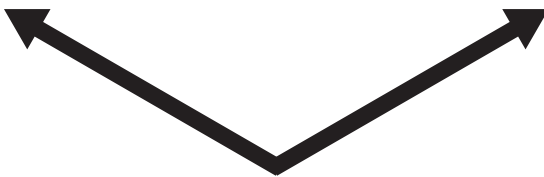

A handy guide for 120 degree angles, the desired angle of a traverse.

“breaks” at each end so the traverse can be temporarily tightened. The best solution, however, is to teach people to cross loose traverses. The problem with having prusik hitches at each end is you are still putting an

excessive load on each hitch and the potential for them to slip or break is much greater than when using them to climb. One exception to the loose traverse rule is when setting up a low traverse for people to get comfortable on. A low, short, and tight traverse is a good training tool and a fun exercise for people just learning to climb.

To tie a traverse, a High Strength Tie Off should be used at both ends. As its name implies, a H.S.T.O is the strongest way to anchor a rope. This is because there are no knots in the line taking any of the load, which is instead transferred onto the wraps. With traverses, it is especially important to use a steel link or locking carabiner for clipping the end of the H.S.T.O. back to itself. It is also good to have just a little tension on the carabiner at the tie off, avoiding any potential rope on rope friction points.

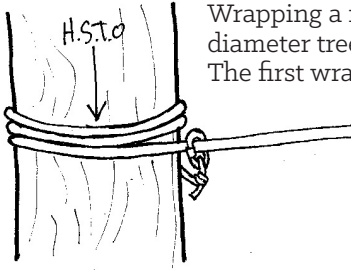

An H.S.T.O. Three wraps is generally good for an anchor. Notice that you wrap up when tying for a traverse. The opposite of wrapping down for a ground anchor.

Wrapping a rope multiple times around a large diameter tree can be a major pain in the ass. The first wrap will be the hardest. A few tricks are to scamper as far around the trunk as your climbing line allows and trying to toss the end onto a branch or something so that you are able to swing around to the other side and hopefully reach around to grab it. You can also try “tapping”—see **Tree Entry.**

Once you have the initial wrap done you can use a handy trick to get a second and third wrap done. Make a bight and tie a butterfly knot on the running side of the line and tie the end of the line into the butterfly making a lose loop around the tree. Then twist the loop around the tree multiple times and you have just completed three wraps with little effort. Make sure to untie the butterfly and to properly finish the H.S.T.O. by tying an eight on a bight with the end and using a carabiner or steel link to clip the rope back onto itself. The only drawback to this technique is that it can be difficult to keep your wraps tidy and uncrossed. It helps to grip all the lines together and move them as one line.

A safe traverse system is actually two traverse lines tied with about 3 feet between the top and bottom lines on the tree. Once you get into the middle of the traverse there will be considerably more space between the two ropes. You can either have the ropes on alternate sides, or both on the same side of the tree. Both ways have their advantages and disadvantages and what is used is generally based solely on the preference of the rigger. Below is a top down view of a traverse tied

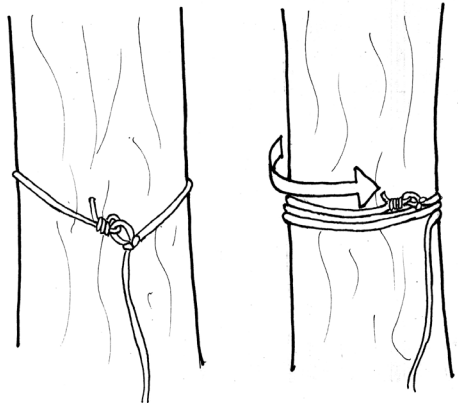

on opposite sides of the trees. Having ropes on the same side of the tree allows the person crossing the traverse to have their arms above their head and keep a straight vertical line with their body.

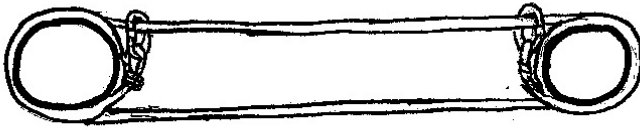

A top down look at a traverse set up. Notice the two traverses are on either side of the trees.

If setting lines on the same side of the tree, you will want them to be a bit further apart than if they are on opposite sides of the tree. You almost want to be hanging just a little from the top rope when you walk across the traverse. Some people feel that walking barefoot across a same-side traverse is the most secure-feeling way to cross a traverse. Having the ropes on either side of the tree allows a person to be able to lean into the top rope a little and can add stability when crossing shorter traverses but could also decrease stability when crossing long traverses. One advantage to traverses on either side of the tree is that when crossing with a pulley you have some space between the lines which can make your life easier and prevent rope-on-rope friction. For the rest of the guide, when referring to traverses we will be talking about opposite side traverses as they are the most common at this point. Ideally when using HSTO anchors to set your traverse there should be no knots anywhere in the load bearing system. Below is what a well tied traverse on opposite sides should look like in regards to the amount of slack present.

What types of rope are acceptable when tying traverses? The key points to keep in mind is that the forces acting on a traverse are much greater than the forces acting on a normal climb line. In an attempt to be able to effectively defend large areas of land with limited resources it is not uncommon for polypropylene rope (truck rope) to be used to tie traverses. Necessity can often dictate the materials that are used in a campaign but making informed decisions is critical. It's true that many poorly tied traverses, with multiple knots in the system,

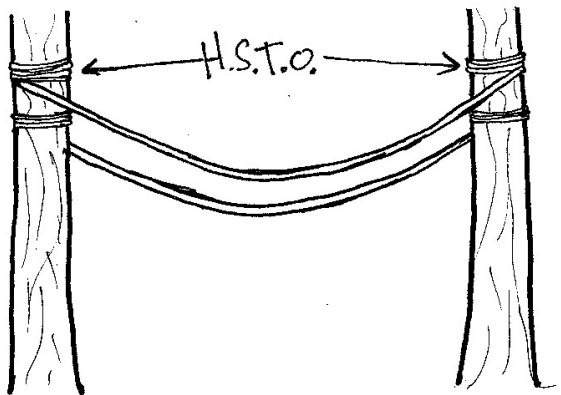

A properly tied traverse



tied with small diameter truck rope, have been pulled tight and not broken under the load of a climber, BUT! that does not mean that they were not incredibly unsafe. It is more by luck than by design that more traverses have not broken under load. The best rope to use is climbing grade 1 static line for the load line and climbing grade dynamic line for the safety line. Static for the load line because dynamic will stretch considerably and will make crossing the line much more difficult. Use dynamic for the safety line because if the load line does break, having the shock absorbing characteristics of dynamic for the safety line will make the fall less jarring and shocking for the system. See—**Climbing Basics**

If you feel you need to place a traverse and don't have enough climbing grade line and are willing to use much less safe polypropylene rope, then use the truck rope for the load line. This may seem counter intuitive as the load line has more weight placed upon it, but if the load line were to break you will be shocking the safety line and the safety line will be much more likely to hold if it is climbing grade line. This being said, traverses should absolutely not be double truck rope. This would be a campaign decision to make, but climbers should be made aware of just how unsafe a double truck rope traverse is. If truck rope is going to be used, please note that 5/8" has an Absolute Breaking Strength of about 80% of 11mm static line. 1/2" is about half the strength of 11mm static. The wise choice is 5/8." If using 5/8" for load line intended for pulley use, beware that many common inexpensive pulleys will not accommodate that size of line. It is possible to buy pulleys that handle extra large diameter line, but they are much less common in the forest defense world.

## **INTERNETS**

Wanna defend more than two trees? Try an internet: a large cargo net, fishing troller net, or circus net hung between multiple trees. Voila: an internet! Multiple folks can "surf the internet" while defending a broader area than a single treesit. This tactic was developed by a group in the U.K. and utilized by activists in the California Headwaters Forest for long-term occupations.

Select 5-15 trees that have enough room between them to deploy the net. Reinforce the edges of the net with climb line or 1" tubular webbing before anchoring it to wrap 3-pull-2 anchors on the various trees. Be sure that there are adequate traverse lines set above the internet so that its occupants can be properly safetied in at all times.



# 6

## CLIMBING BASICS

**SAFETY DISCLAIMER:** These are training outlines and are not meant as a substitute for going through a training with an experienced climb trainer. You need to go through a proper training before attempting ascending and midline descent or any other climbing related activities. See **Resources** about organizing a training.

# >>> CLIMB TRAINING ORIENTATION FOR BEGINNING ASCENDING + DESCENDING

*NOTE: You must learn to mid-line descend on your first climb*

## KNOTS TO LEARN

- **Figure Eight Follow Through**
- **Eight on a bight**
- **Double Fishermen**
- **Water knot**
- **Prusik hitch**
- **Girth hitch**

## MINIMUM EQUIPMENT NEEDED:

- **Harness:** Tree (arborist) harnesses are very padded, used for long time periods on rope. Rock harnesses are for short term climbing.
- **Carabiners:** 3 locking, 1 non-locking for gear, extras are useful.
- **Descending Device:** aluminum figure 8 or ATC are most common
- **Ascending loops/slings:** lead ascending loop, foot ascending loop with safety loop and webbing for foot loop, plus one or two extra slings. Loop and sling are interchangeable terms.
- **Heavy Glove:** or some other heavy fabric to hold while descending; optional
- **Clothing:**
  - >> Lightweight clothes, preferably more tightly fitting
  - >> Shoes with a good sole
  - >> Hair-ties for all hair lengths
  - >> Empty large items from pockets or secure items in zipper pockets, and tuck in or remove jewelry.
  - >> Climbing gloves—bike gloves or snug-fitting garden gloves work great.

## GEAR SAFETY CHECK:

**1. Tape** on any gear (prusik loops, carabiners) could indicate that the gear may be retired. Duct tape is corrosive and shouldn't be on any active gear. Trainer should know why tape might be on gear as it is sometimes used to distinguish ownership.

**2. Harness:** Check for frays in webbing, function of buckles, split stitching, crack in any metal safety points, defects, etc.

**3. Carabiners:** Check gate and screws to see if they are in good working order.

**4. Descending Device:** Check for small fractures, burrs, deep surface scratches, etc. Worn finish is usually OK. You should know if this device has been dropped, if so put tape on it and mark it to be destroyed. This is also true for carabiners or other metal safety devices

**5. Prusik and Climbing Rope:** Check for frays in sheath that reveal the core, flat spots, hard spots, chemical burns, excessive tree sap, any visible core, and correct knots. Knots should have at least a 1 ½ inch tail after the knot. Foot ascender loop should have a correctly tied water knot in the foot loop webbing and a girth hitch to connect the loop to the prusik. The climb line should have a figure eight or barrel knot on the end of it.

## **THE PSYCHOLOGICAL ASPECT OF CLIMBING: WHAT YOU SHOULD FOCUS ON AS A TRAINER/ CLIMBER**

***CLIMBER:*** *it is your and your trainer's responsibility to know the following before you climb.*

- You should know at all times the dependability and experience level of your trainer. If you don't feel comfortable with the trainer, do not climb. If you have communication problems with the trainer, do not climb. If the trainer seems unfocused, do not climb.
- You should ask as many questions as possible to feel confident in each aspect of climbing. You should always know what you're getting into and why. Make sure you are comfortable with what you are going to be doing. Know each aspect of the climb—safety, ascending, and descending—before you start climbing.
- Be sure to maintain awareness and a calm body and mind. If you aren't well rested, maybe you should learn to climb another day.
- Do not try anything your trainer has not instructed you in.
- Keep your safety and others' in mind at all times.
- Maintain two points of safety at all times while climbing. No exceptions.
- You should know all the knots listed on the knot page and how they are applied and used.

- Know how a descent device works and how to use it.
- You should have inspected all the gear with your trainer (see gear safety check).
- Make sure you and your trainer have checked all safety points.
- Make sure your gear fits.
- If you have taken drugs that impair your mind or body—this includes marijuana and all forms of alcohol, do not climb.

***TRAINERS SHOULD KNOW THE FOLLOWING: it is your responsibility to make sure the climber reads this paper and climbs safely and responsibly. People's lives depend on it.***

- You must teach a climber how to mid-line descend on their first climb.
- You are potentially placing someone's life in danger if proper safety techniques are ignored.
- You must be a confident and very experienced climber before you are a teacher—no exceptions. In addition to being very comfortable with ascent and descent, you must also know the aspects of climbing regarding **Anchoring, Rope Strengths, Physics, and other Technical Insights**.
- You must stay mentally connected at all times with the climber. Do not allow yourself to become distracted by anything. If someone else is talking to you besides the climber, tell them you must focus on the climber and ask them to not disturb you.
- You must know what bad gear looks like and should know the history of the gear being used.
- If the climber seems uncomfortable with this training tell them there is no rush and they can wait for another day.
- You cannot be under the influence of any drugs.
- You must be alert and focused. Do not teach someone if you are not mentally prepared to do so.
- Remember to have patience.

- If possible, it is best to have two lines next to each other so a trainer can go up next to the person being taught.
- If two lines are not possible, it is a good idea to rig training lines so they are anchored at the ground and run through a pulley anchored to the tree or other structure. This allows the trainer to belay a climber from the ground if they were to freeze up while climbing. Only attempt this if you are familiar with belay techniques as you will be in total control of the person's descent and subsequent safety.
- If you feel a climber isn't ready or capable to climb safely then you have a responsibility to that person and the campaign to refuse training. You are the trainer and it is your call. Don't let anyone guilt you or pressure you into a training you don't feel comfortable giving.
- Remember you are a role model, so set the safest example possible. You reflect the campaign. Safety is cool; showing off is not. Don't let your ego get in the way.

***Once the climber has read over the climbing guide, gone over all the knots, checked and assembled their harness and gear, and gone through a climbing demonstration, they may climb under the trainer's supervision.***

## **SAFE CLIMBING STEPS AND THE ABC'S OF CLIMBING**

For clarity these directions are for right-handed people. Left-handed individuals need only to reverse the steps that make a right/left distinction.

### **HARNES:**

- Pull harness up over your hips. The upper strap should rest on top of your hipbone.
- Make sure to double back your harness belt and keep the harness snug. A belt not doubled back or a harness too loose is as good as no harness at all. Double back your leg straps if there are any.
- If your harness is too big or too small, switch it out for a better fitting one.
- Do not ever hang or put any of your weight on the accessory loops, located on the sides of the harness.

### **CARABINERS:**

- Attach carabiners through loops on the front of the harness. The exact loops and positioning of carabiners varies from harness to harness.

- When looking down on carabiners make sure that the gate is facing out and away from your body. When locking the screwgates, they should screw down, think; “Screw down, so you don’t screw up!”

- You should have three carabiners facing the correct way, the left hand one is for your foot ascender, the center one is for your lead ascender, the right hand one is for your 8/ATC. The carabiner that has the 8/ATC in it could have webbing over it for extra protection. The large hole on the 8 should be clipped into the carabiner.

### **ASCENDING LOOPS:**

- Attach lead ascending loop to climb line with a prusik hitch and then use a girth hitch to attach to the center carabiner. Lock carabiner.

- Attach foot ascending loop to climb line with prusik hitch. Let hang.

- With girth hitch, attach the safety loop on the side of the foot ascending loop that doesn’t have the fisherman’s knot.

- Attach safety loop with a girth hitch to the left carabiner. Lock the carabiner.

### ***Before climbing, go over the ABC’s***

**A. ANCHOR:** Hang on the climb line to ensure it is safely attached and will not fall. Know exactly how it is anchored, who anchored it, and when it was anchored. Think about anything that may have compromised the anchor.

**B. BELT/BUCKLE:** Are all the leg and belt harness buckles doubled-back? On New Tribe tree harnesses make sure your delta steel link is screwed down.

**C. CARABINERS:** Make sure only one rope is attached to any one carabiner. Make sure all carabiners are locked, facing the correct way, and are clipped into the proper points of your harness. When locking carabiners, don’t over tighten. If a carabiner is too tight, the extra pressure of hanging off it can cross thread it, making it really freakin’ hard to unscrew.

**D. DEVICES:** A device is whatever you are actually using to climb. In the instance of ascending up a line, the devices are your ascending



loops. Make sure the knots/hitches/bends are dressed correctly and you have two points of safety. In the instance of rappelling—i.e. a mid-line descent, the devices are your figure 8 or ATC, and your safety loop. Check over yourself, your knots, and your devices. Also make sure nothing is tangled.

**E. END OF ROPE:** Is the end of the rope close enough to the ground? How good is the knot on the end of the rope?

**F. FRIENDS/FEELINGS:** Make sure that there is ground support that can hear you. Also do a little check with yourself to see how you're feeling. Do you need to pee? Have you gotten enough sleep? Are you comfortable with the trainer who is helping you learn to climb?

**G. GEAR:** What extra gear will you need from the moment you leave the ground until come back down? Slings, pulleys, food, water, etc...

**H. HAIR/HELMET:** When climbing and descending, pull back your hair or it will get caught in the figure 8. This goes for facial hair, loose clothing, and even nipples. Seriously it happens. A helmet can be a great safety addition as you never know when a branch may fall.

*If you have any more questions, ask your trainer. If you don't want to climb, now is the time to speak. But otherwise, have fun.*

*Assuming all gear is safety checked, you know the knots and the mental aspects of climbing and have done the ABC Safety check, you're now ready to climb.*

## ASCENDING

1. The first thing to do when attached to a line and about to ascend is to understand how to loosen the prusik "gate" to slide the hitch up. The "gate" is the part of the hitch where the rope crosses over itself. The prusik hitch is designed to be able to slide easily on a climb line when there is no tension on it, but as soon as any weight is applied, the hitch tightens and locks on the climb line. To loosen it, first make sure there is no tension on the hitch, then push the gate back with your thumb. To lift it, pull it up with two fingers on either side of the climb line right under the hitch. Kind of "pushing it back, and hooking it up."

2. Give a little jump and slide up your lead prusik as high as it can go. Take a seat and hang from it. You may swing a little but that is natural.

3. Make sure the climb line is between your legs and put your foot into the foot loop. It should rest in the middle of your foot. Take any weight off the foot loop—keeping your foot in the loop. Loosen and pull the foot prusik up as high as you are able; your foot goes up as you pull it up. Make sure to leave at least 5 inches between the lead prusik and the foot prusik hitch.
4. Grab the climb line under your lead prusik hitch. Step up into the foot loop; and bring yourself into a squatting position. *The prusik hitch is not to be used as a hand hold for pulling yourself up or lowering yourself. Only use your fingertips to move it.*
5. From this squatting position you're going to loosen your lead prusik hitch. Now stand up fully in your foot loop as you slide up your lead prusik.
6. Once the lead prusik is pushed up as high as possible, let go of the hitch, sit back in your harness, and repeat this process over again until you reach about 10 feet off the ground.

A lot of people have a hard time with sliding the foot prusik up because they keep their knee straight when trying to push it up, thus creating an amount of force just enough to stop the prusik from sliding. The prusik won't slide if there is any pressure on it. If you're having problems, try bending your knee as you raise your foot.

## **MID - LINE DESCENT**

*If you are learning to climb you must learn to mid-line descend. Learn this at about 10 feet from the ground on your first climb. This ensures no one panics high-off the ground and has to learn it in a bad spot.*

1. Slide your lead prusik up as high as possible and then hang from it.
2. Remove your foot from the foot loop, then slide your foot prusik up and out of the way.
3. If you are right handed, make sure the climb line is on YOUR right side.

### **IF USING A FIGURE 8**

Hold the 8 so it is parallel to the ground. Take a bight of rope and pass it toward the ground, through the large hole of the 8.

Next, slide the end of the bite up over the small hole. Unclip the 8 and rotate it 180 degrees, spinning the small hole toward the ground. Clip the small loop into your right carabiner and lock the carabiner. Make sure your 8 is facing the right way with the rope exiting on the side of your rappelling hand.

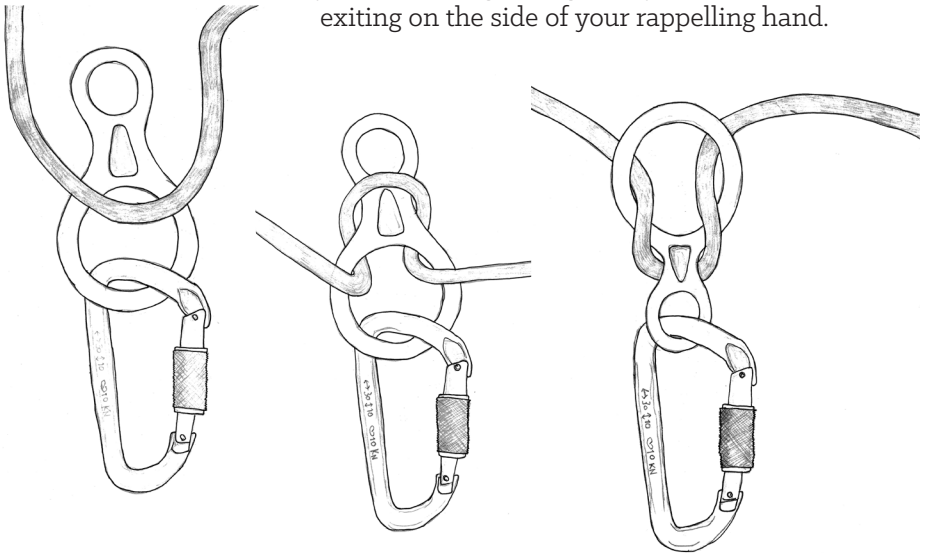

#### **IF USING AN ATC**

Form a bight of rope and pass it through the basket of the ATC. Clip the bight into the carabiner that the ATC is in and lock it.

Pull up on the tail end of the rope (towards the top of your head) and pull down on the standing line to get the slack out between your descent device and lead prusik hitch. Make sure all slack is taken out. If you are right handed, make sure the tail of the climb line is on the right side.

4. When adding or changing points of safety it is important to redo the ABC's to double check all points of safety. Remember, you must have at least two points of safety at all times.

In order to descend you must loosen your lead prusik and get it within reach, then transfer your weight to your descending device.

5. At this point you may want to be wearing the heavy glove on your brake hand—your right hand if right handed. Lower your foot prusik to just above your descending device. Put your foot into your foot loop.

6. Step up and lower the lead prusik.

**7.** Before you sit back, place your brake hand on the climb line under the descending device. As you sit back, move the running end of the line under your butt with your brake hand, with sharp downward pressure, so you are in essence sitting on your hand, while holding the rope. Now you're ready to descend.

**8.** With your left hand, hold your loosened lead and foot prusik hitches. The way to hold them is by making a "raptor claw," using your fingertips to push down the lead prusik from just above it, and your thumb to push down the top of the bottom prusik. The thumb also keeps a small gap between the two prusik hitches, keeping them nice and tidy. Do not grab the hitches directly, just use the tips of your fingers and thumb. If one tightens up you won't be able to slide down the rope. If you start going too fast, you want the prusik to catch and stop you. People have a natural tendency to grab on when falling, and if you were to grab a prusik hitch, you could prevent it from catching. Thus, use your fingertips in a raptor claw above the hitches as opposed to grabbing the hitch itself. The lead prusik hitch should be at about eye level just above the descent device and stay there the entire descent. Once again, it is really important to make sure you slide the prusik hitches down with you at eye level. If one catches, you have to do the process over from step 6.

**9.** Start to slowly loosen your grip with your brake hand. Let the rope feed through the descending device and your prusiks. Don't ever grab the lead prusik tightly. The grip of your brake hand will be controlling your speed.

**10.** Do not go fast. If you start to go too fast, tighten your grip on the line with your brake hand or move your brake hand under your butt. **If you're going too fast or at any time feel out of control or unable to continue to grip the line let go of your lead prusiks. This will catch you.** Remember that you'll have to step back up to loosen it again if you do this.

**11.** Be **VERY** careful not to get anything caught in your descending device. Hair and loose clothes get easily sucked in. In a few cases peoples' nipple rings and even breasts have been caught in descending devices, so this can't be stressed enough.

**12.** Watch out for branches and how far from the ground you are.

**13.** As you approach the ground, slow down and prepare to come to a slow connection with the ground. Approach in a nicely balanced manner with your feet as downward as possible. Keep your knees bent. Be careful not to step on the line when you come down. Come all the way down to a squat before stopping to make sure all the tension will be off your prusik hitch when you stand up.

14. Once you are on the ground undo the descending device from its carabiner, take it off the climb line, and return the descending device to the harness. Make sure you do this right away, as after long rappels, the descending device will heat up and if left on a line, the heat will degrade it. Take the lead prusik and foot off their carabiners and the climb line and return them to an extra carabiner on the harness. Take off the harness and put it in a safe spot—i.e. not in the dirt. Be careful not to step on the rope.

15. Talk to your trainer about any problems or anything you need clarified. Make sure to thank your trainer. Talk to them about your climb and spend a moment reflecting on what went well and what to work on next time.

16. Bask in the glory of having just climbed up into a magnificent tree.

17. Are you ready for a more advanced training?

**NOTE ON MIDLINE DESCENT:** This method is good for the first ascent not exceeding 10-20 feet. Once the climber has become comfortable with this method, they should be shown how to take off the foot loop from the climb line. The easiest method for this is to hang from the lead prusik and bring your right foot up as if you were sitting cross legged. Wrap the running end of the rope around your foot 4 times, then cross your left leg over your right foot so that the wraps are in the bend of your left knee. This will prevent the wraps from coming undone while you remove the foot loop and foot prusik. Once the foot loop is off the line then you should be able to step with your left foot directly on top of your right foot pinching the climb line loops between them. You can then stand up and slacken your prusik. This will put you back into a position to start rappelling once you have grabbed the rope below the descending device and applied sharp downward pressure and shake off the loops of the climb line from your right foot.

### USING THE MULE HITCH WITH AN ATC

A mule hitch can be used to lock off your ATC, allowing you to pause in a rappel or belay, freeing up your hands for tasks other than minding your rope. While tying a mule hitch with an ATC can seem a bit tricky at first, it's a skill worth learning. The mule hitch is often used in performing rescues.

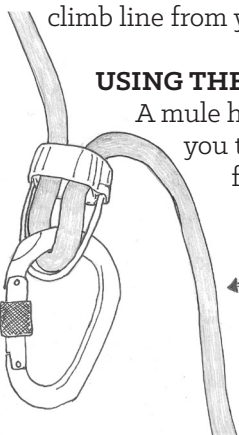

Instructions will be for someone who is right-handed. First, pull the standing end of your rope with your right hand—your brake hand. As you're

keeping tension on with your brake hand, pass a large bight of rope from right to left through your carabiner. Continue with this bight, around the back side of the standing line, above your ATC and form a loop. Hold the loop with your brake hand and pass another bight around the front of the standing line, through the loop your brake hand is holding. Cinch the knot by pulling the bight and finishing with a half hitch.

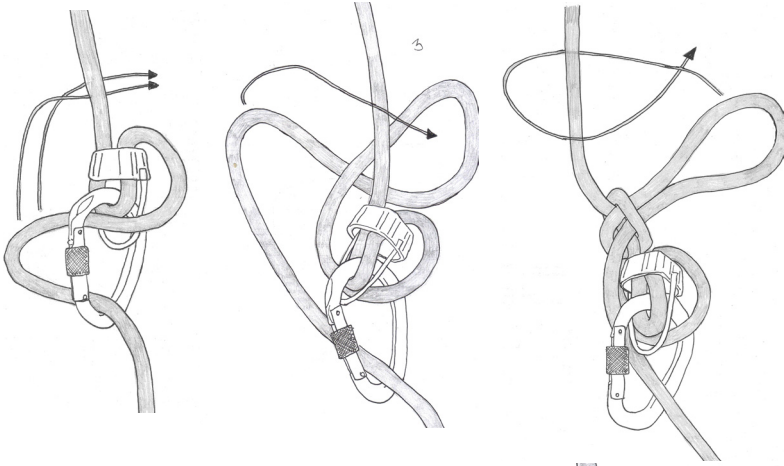

Your ATC is officially locked off and is counted as a point of safety. As soon as you start to untie the mule hitch, it is no longer a point of safety. When you're ready to continue your descent or belay, start by applying pressure to the rope coming out of the ATC with your brake hand. Now you can start untying the hitch with your other hand. When you get ready to pass the rope back through the carabiner, be prepared to slide your brake hand into position to continue your belay or rappel.

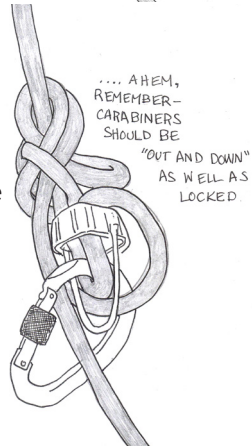

## INTRO TO CROSSING TRAVERSES

**NOTE:** *Rigging traverses is a whole different ball game from learning to cross them. See Rigging Traverses and Internets for info on how to set them up.*

One common use of traverses in forest defense is to connect two trees and being able to cross a traverse is a skill that comes in handy quickly at many forest campaigns. These traverses are usually slack in order to make them more able to handle the force of a climber. Setting up traverses safely requires some math and solid understanding of the physics of rope and rigging. When transferring from one line to another,

as in transferring to a traverse, you must retain at least two points of safety. The easiest way to do this is to add a third point of safety, which will allow you to move one of your original points of safety. Below are the steps for crossing two types of traverses.

### **PULLEY TRAVERSES VS. WALKWAYS.**

There are two main ways to cross a traverse: by attaching a pulley to the upper line and a safety lanyard to the bottom line and crossing via the pulley or by standing on the bottom line and walking across the line, using the upper line for stability. Many folks prefer pulley traverses as it is easier to cross a slack traverse using a pulley and some prusiks.

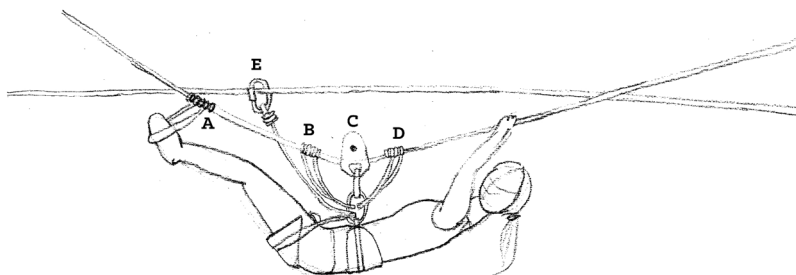

***In a pulley traverse***, the top line is the load line and the bottom line is the safety line. To transfer from a climb line to a pulley traverse you want to be high enough on the climb line that you are able to easily clip your pulley onto the top line (C).

- 1.** Use a locking carabiner to connect the pulley to one of the locking carabiners connected to the bridge of your harness that is not attached to the main climb line. Some folks may like the connection to be lengthened even a couple inches further with a very short sling between the two carabiners. You should still be able to clip your safety lanyard onto the bottom line (E) from the same spot on the rope.
- 2.** At this point it is a good idea to tie a prusik with a short sling on the top line behind the pulley (B). This sling serves two functions. First, it will keep you near the tree you are leaving from until you are ready to cross the traverse and secondly, if the load line were to break, it will cinch down on the line and not just slide off, keeping you attached to the line.
- 3.** Unclip your foot ascender safety from your harness. Only do this after the pulley has been installed. You need two attachment points at all times. Clip the sling that is attached just behind your pulley into a vacant



carabiner at the bridge of your saddle. Now “reverse prusik” down your climb line until your weight is on the traverse

4. Unclip your lead ascender from the carabiner and install your safety lanyard. Clip the safety lanyard onto the lower traverse, then clear all of your gear from the climb line.
5. You may also choose to add a fourth locking carabiner to your harness, tie a prusik in front of the pulley with a short loop (D), and clip it in. This will act as a progress capture when you are past the nadir—low point—of the traverse. It may be easier to install this in your harness now, rather than in the middle of the traverse, but you will have to keep your fingertips on it as you slide down the traverse, keeping it away from the pulley. Some pulleys are “prusik minding” and will push the prusik along, rather than suck it up and make a big mess.
6. You should now have your pulley (C) on the top line with a prusik behind it (B) and a second safety lanyard on the bottom line (E). You should have points E, B, & C on the line but not A & D. To get going, you should be able to step up on the bottom line just enough to be able to release prusik B and away you go. Just like repelling, use your fingertips atop the prusik hitch—both if you’ve chosen to tie (D) already—to keep it moving with you.
7. Once you reach the nadir of the traverse you are going to want to add a prusik in front of your pulley (D), if you haven’t already, and remove the prusik behind it (B). You are going to need to pull yourself the rest of the way across the traverse using the short loop (D) as a progress capture. If you use a short sling and keep the prusik at D a little loose, the pulley itself can advance the prusik, and you won’t have to worry about advancing it yourself.
8. If the angle of the traverse is too severe to be able to pull yourself across then adding a sling at A to be used as a foot loop can be very helpful. In this manner it is possible to cross a slack traverse effectively and in the safest manner possible.
9. Once on the other side, begin your transfer to the climb line by removing the safety lanyard from the bottom traverse and add a lead prusik to the climb line. Clip in to the lead prusik. Add your foot loop to the climb line and ascend the climb line until you can unweight the pulley. Remove the pulley, then clip into your foot ascender safety. Remove the prusik on the upper traverse.

***In a walkway traverse***, the bottom line is the load line and the top line is the safety line. To transfer from a climb line to a walkway traverse, get to a

point on the climb line where you can sit on the bottom line and get most of your weight onto the line.

1. Once sitting on the bottom line you can attach a sling with a prusik onto the top line, clip it into an unused locking carabiner on the bridge of your harness, then remove your foot ascender safety.
2. Next attach your safety lanyard onto the bottom line.
3. Stand up and remove your lead ascender from the climb line and strip your gear from the climb line. You are using a prusik on the top line so that in case the line breaks, you will not just slide off the end. It may help you to tuck the top line of the traverse into your armpit to free your hands.
4. Standing on the bottom line you can shimmy your way across the traverse keeping your safety lanyard between your feet. This can be exceedingly difficult on a slack traverse.
5. Once across, transfer back over to the climb line, keeping two points of attachment at all times.

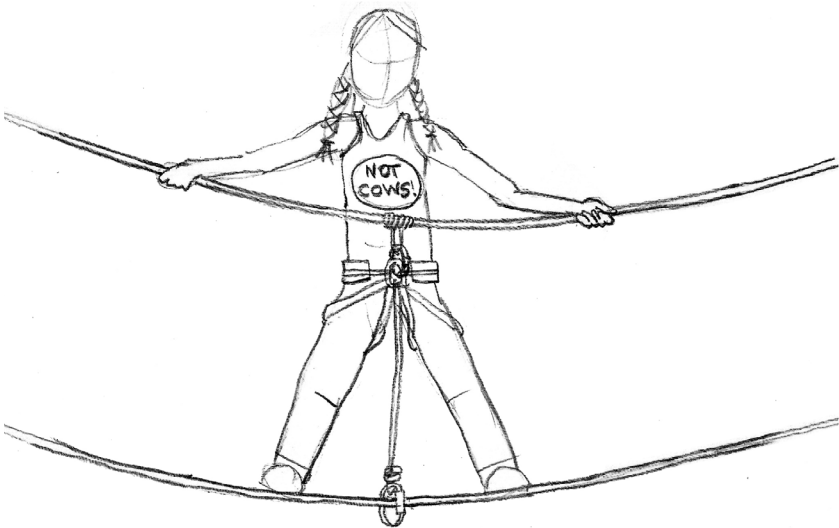

# >>> ANCHORING, ROPE STRENGTHS, PHYSICS, + OTHER TECHNICAL INSIGHTS

*This section deals with rigging in trees. While most of the information presented here is applicable to other situations, keep in mind that it was written with tree rigging as its focus.*

The purpose of this section is to help individuals who have a basic understanding of rope work and rigging to expand their working knowledge of rope. It is critical that people understand everything in here before they start teaching other people or attempt to do any rigging. Those of us that do rigging in direct action settings have a responsibility not only to the individuals that trust their lives to our knowledge, but also to the campaign we are working within. Unsafe situations in rope work are never acceptable. Granted, unless you have the luxury of being funded by a wealthy organization, you have to make due with what is available. However, there is no excuse for unsafe rigging. The absolute first step in becoming a rigger is to understand the forces at work when dealing with complex or even simple rope systems.

A good place to start is with a discussion about rope. The two types of rope that are typically used in our circles are dynamic and static. There is also specific arborist rope, but for the sake of uniformity we will only be discussing static and dynamic rope.

ROPE SIZE (DIAMETER)	TYPICAL BREAKING STRENGTH
3mm	380 lbf. (1.7kN)
4mm	745 lbf. (3.3kN)
5mm	1,350 lbf. (5.5kN)
6mm	1,600 lbf. (6.8kN)
7mm	2,200 lbf. (9.3kN)
8mm	3,500 lbf. (14kN)
9mm	4,300 lbf. (16.2kN)
10mm	5,700 lbf. (25.4kN)
11.1mm (7/16")	7,000 lbf. (30kN)
12.7mm (1/2")	9,000 lbf. (40kN)
16mm (5/8")	15,000 lbf. (66.7kN)
25mm (1" webbing)	4,500 lbf. (25kN)

What's the difference and why do we use static rope? Dynamic stretches. If shock loaded—a load suddenly placed on the rope like if the rope catches someone from a free fall—it could stretch as much as 35%. Static is designed to minimize stretching under load. It would be impossible to have a 0% stretch when dealing with rope, but generally you will only encounter a stretch of about 6% when dealing with static rope. Arborist rope is static with very low stretch as well. The exact amount of stretch and the strength of the rope will vary between rope manufactures and diameters, but the numbers here are just a rough average.

*Before we go much further a brief note on what kN means. kN is the abbreviation for kilo-newtons, a measurement of force. Named after Isaac Newton, the newton is the force of Earth's gravity on an apple with a mass of about 102 g. The kN is 1,000 newtons, or*  
**1 kN = 224.81 pounds of force (lbf)**

So, what's with the stretch and why don't we want it? Dynamic rope is used in rock climbing where, if a fall occurs, it could potentially be a very large distance and a climber would need the shock to be absorbed. We often use it as a safety line in a traverse. Static rope is used for rappelling, prusiking, and other systems involving constant tension on the rope and there is little chance of a shock load. Static ropes are more durable and resistant to abrasion.

When climbing in the context of forest defense you should always have two safeties attached so that if loaded, one will catch instantly and not allow a free fall and subsequent shock load. A force of more then 6kN on the human body can cause serious harm. Search and Rescue groups around the world recognize this number in all their rigging techniques. The force of a fall grows exponentially until the weight reaches terminal velocity. This is relevant to us because a fall of 4-6 feet can easily generate more then 6kN of force, depending on the mass and velocity of the person. Meaning... a 4 foot fall, if taken just wrong, can break your back.

Keep in mind that the laws of physics apply equally to falling objects such as figure eights, ATC's, and carabiners. If any climbing gear falls from a significant height, a serious evaluation must be made of whether or not to retire the item. Figure 8 descending devices are especially fragile in this regard.

If you drop gear or knock a branch down you need to yell to the ground to warn them. "Heads up" isn't the best choice because most people will just look up. Something that imparts the impending impact like yelling "HEADACHE" works well. On that tip, if you hear "HEADACHE" being yelled from a tree, don't look up. Get away from the tree.

## HARNES PATHOLOGY

While on the subject of safety it seems prudent to mention the bodily effects of restricted blood flow due to harness wear, aka harness induced pathology. We are not talking about normal usage of a harness; we are talking about what can happen if a person becomes prone and motionless for a period of time while hanging in a harness. If blood flow is significantly restricted to the extremities then toxins can build up and the removal of the harness will then allow those toxins to slam into the heart potentially causing cardiac arrest. This has been known to happen after only 10 minutes. If someone becomes limp in the harness, the first step is to get them down as quickly as possible.

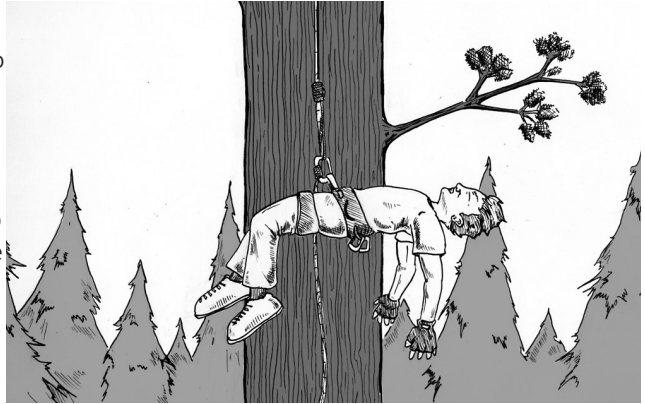

Rescue techniques are complex and can't properly be covered in only a few pages. Familiarizing oneself with basic rescue techniques is something that all serious climbers will do. Check out the CMC website at [cmcrecue.com](http://cmcrecue.com). They are a company that manufactures rescue gear, publishes books on the subject, and offers classes. Upon completion of the classes you get a handy certificate that is recognized by all search and rescue organizations. Another good book to check out is *Climbing Self-Rescue: Improvising Solutions for Serious Situations* by Andy Tyson and Molly Loomis.

You may be put into a situation where someone needs help and you'll have to use your own best judgment in getting the person to the ground. One thing to remember is **NEVER BELAY OFF YOUR OWN HARNESS!** The first rule in belaying someone or something else for rescue, is that your belay point—the anchor the belay device is attached to—must be fixed. If you belay someone off your own harness and for what ever reason the system becomes shock loaded you will be pulled off your feet and will most likely lose control of the belay. Worst case scenario you could be pulled off a cliff or out of a tree.

## ROPE CARE AND STORAGE

First off, **NEVER STEP ON YOUR ROPE.** This is a very important thing to keep in consideration when rigging. By stepping on the rope, you are

working in all kinds of dirt, sand, and other debris that will then go to work sawing the fibers of your rope. A long standing tradition is that if you catch someone standing on your rope, that person owes you a beverage of your choice! When setting lines in trees, it is important to keep an eye on the amount of rope that is left on the ground. It is much safer in the long run if you make it a standard practice to tie anchors with the excess rope in the tree instead of it hanging out on the ground, waiting to get stepped on. If there is extra hanging, you can coil it up so the excess hangs instead of lying on the ground. On this same note, it is also a good idea to occasionally wash your rope. Use a very mild soap, like Doctor Bronners, and run your rope thru the delicate cycle on a front loading washing machine. You should avoid using a washing machine with the central agitator. Don't use heavy detergents or bleach and don't run your rope through a dryer. Let it line dry, preferably not in direct sunlight. Never put a rope away if it is wet. Mildew could form on it and effectively destroy the rope. **Mildew = rope destruction.** Keep this in mind if rigging in the rain and while putting gear away after an action. It's a big bummer when you open a bag of gear that's covered in mildew.

Inspect your ropes between uses. A few signs of a compromised rope are soft spots, an hourglass shape, puffs, and boogers—a little fraying is to be expected but if you can see the core then the rope is done.

Knots compress ropes when under tension. If a double fisherman's, figure eight, etc. has been under tension, be aware that the rope may be significantly weakened at the spot where the knot was tied. Some folks cut their rope just past old anchor knots to be safe. It should go without saying that you want to keep your rope as far away from solvents, strong acids, or alkalies as possible, nowhere near that car battery you power the radios with, the store of AA's for headlamps, or camp stove fuel.

Use a rope log to keep track of how old ropes are and what kind of action they have seen. Most new ropes come with a little pamphlet that includes a rope log, and it is always a good idea to mark your personal ropes with colored electrical tape at the end so they don't get lost in the mess of communal gear.

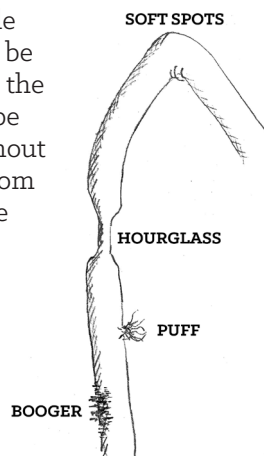

Rope storage is very important. If you try to coil a rope by just wrapping it around your arm you can put a lot of twists into the rope which can cause it to become a big knotted mess when you try to uncoil it. The best way to store and travel with rope is to stuff it into a rope bag. The rope bag can be any type of bag from a fabric grocery store bag to a nice

hiking pack. The rope bag should have an attachment point for the rope inside it so when the rope is being pulled out the end won't get away from you. This method works great, from climb lines all the way to small diameter throw lines. If you don't have a bag then you can either butterfly coil the rope or daisy chain it. Try both methods out and see which one you like best.

### KNOTS

Ya gots to know knots... Lots and lots of knots. At the end of this section, you will find a couple of pages of knots that are especially important. If you want to really know your knots, you are going to need a knot book. There are tons out there, but a good one is *The Book of Knots* by Geoffrey Budworth & Jason Dalton.

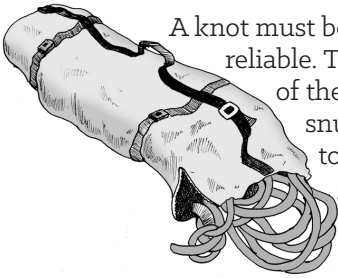
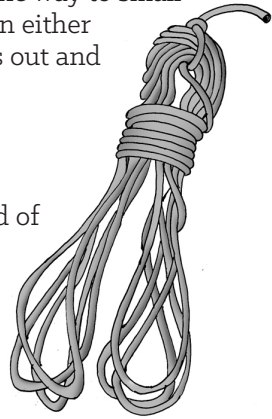

A knot must be dressed properly before you can consider it reliable. This means that you should make sure all parts of the knot are in their proper place and cinched snug. Improperly dressed knots are more difficult to inspect, could be prone to slipping and can greatly reduce knot strength. An improperly dressed knot can degrade knot strength by up to 50%.

To retain full strength, many knots must also be loaded properly. The most abused knot in forest defense is the butterfly. The butterfly is a fun knot to know, but its practical uses in the context of forest defense are limited. It is the best knot to use when dealing with a 3-Way pull but it is often used in a situation where the pulling force is 2-Way. In these instances the proper knot to use is an inline eight. Know your knots, and know what knot to use where.

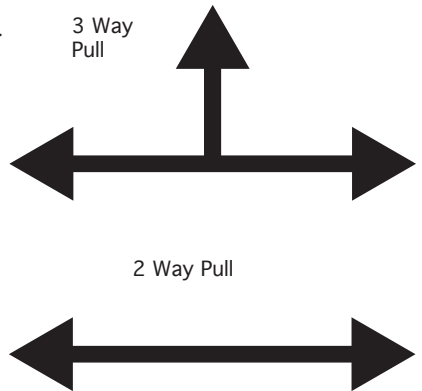



## A FEW COMMON KNOTS AND THE PERCENTAGE OF ROPE STRENGTH DEGRADATION. (RESULTS WILL DIFFER WITH DIFFERENT ROPE TYPES)

Figure 8 follow through	19% lost	Water knot (webbing)
Figure 8 on a bight	20% lost	Figure 8 loop (webbing)
Double Figure 8 loop	18% lost	Rope with a loop in it. (pulled end to end)
Inline Figure 8	25% lost	
Butterfly	25% lost	Figure 8 loop
Bowline	33% lost	Inline Figure 8 loop
Double Fisherman	21% lost	Butterfly loop

### FRICITION

#### *Your best friend and your worst enemy*

What keeps your prusik from sliding down the line? Friction. But, what can cause major rope wear and potentially deadly situations? Friction. We rely on friction to climb ropes when using knots and hitches like prusiks and klemheists. These hitches only work when they are a certain percentage smaller (about 30%) than the rope that they are attached to. You want to use a rope at least 4mm smaller for your prusiks than the rope that you are climbing. Meaning, if your climb line is 1/2" (12.7mm) then you should not use rope larger than 8.5mm to tie your prusiks. While this is the largest size you should use, it is not to say that this is the size of rope that you would want to use. The most common sizes to use when prusiking are 5mm, 6mm and 7mm. What you use is purely a question of personal preference. Many folks prefer 6mm rope because 5mm can have a tendency to cinch down so hard it is difficult to loosen and 7mm is more likely to slip slightly, once weighted.

Now for the bad. An excellent demonstration of just how destructive friction can be to rope is by doing what is called "The 10 second demo." Get 2 lengths of old rope that you don't mind destroying. The lengths should be about a meter long each, and the type of rope doesn't really matter because the point will get across no matter what you are using. Have one person hold both ends of one of the lengths. Loop the other rope through and hold one end in each hand. Tell your fellow demonstrator to brace themselves and begin to saw the section of rope they are holding with your section. If you are aggressive enough with your sawing, you should be able to cut thru the other rope in

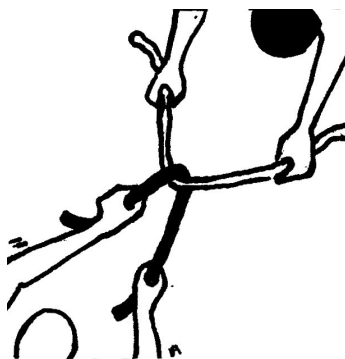

about 10 seconds! It will take slightly different amounts time for different ropes, but you get the idea.

Rope on rope friction like this should be avoided at all costs. This is especially important for all anchors and rigging. Any time a rope crosses another rope there should be some sort of protection. A collection of old garden hose is good to have around to use as a sheath over rope at any points where it comes into contact with a possible friction source (another rope, a branch, an edge of a platform or a hole thru a platform, etc). You can also use tubular webbing as a little extra protection for rope if hose is not readily available.

Friction is also a consideration in how your ropes are impacting the tree you are climbing or rigging from. Avoid pulling loads up by just running a rope over a branch. In a pinch use a carabiner, but a large diameter pulley is preferable. If the tree is softwood you can easily cut through the bark and into the cambium layer (the layer under the bark that the tree uses to pass along nutrients). If the cambium is badly damaged, you can kill the section of tree beyond the cut. Some arborist climbing methods involve running a rope over a branch and getting up the tree by pulling down on one end of the rope. These methods generate a massive amount of friction on the branch, and while many trees—hardwood deciduous trees—can handle this friction without a problem, many trees would be heavily damaged—softwood coniferous trees. Be attentive to the amount of wear you are causing on a tree. It would be a tragic irony if in the process of trying to save a tree, we end up killing it through our own actions.

### **SCREW LINKS**

A large collection of screw links is just about essential when doing any rigging. A well outfitted rigging bag may contain a pouch with about a dozen good sized screw links. They are used in just about every anchor to eliminate rope on rope friction. You should try to get a stockpile of climb rated steel links, but in most cases steel links that you would get at any hardware store will suffice.

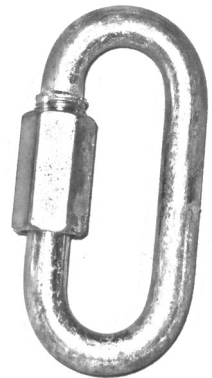

### **CARABINERS**

Before getting into anchoring, let's talk about carabiners. There really is a multitude of carabiners out there. One major difference is locking vs non-locking. Non-locking carabiners have a gate that opens just by pushing on it. They are quick, lightweight, and relatively cheap. Locking carabiners have some mechanism that will lock the gate closed until someone chooses to unlock it. The locking

carabiners can be further divided into screw gates and autolockers. The screw gate requires you to manually unscrew a threaded sleeve that prevents the gate from opening. They are a bit slower, but very dependable in most conditions, and they are easy to operate one-handed. The autolockers have a few varieties, but the common feature is that you have to twist a sleeve and push the gate at the same time. They are spring loaded and will lock when you remove your fingers. These may be more trouble in dirty or cold conditions, sometimes require two hands to use, and are more expensive.

Carabineers also come in aluminum and steel. Steel is heavier, but much stronger and resistant to cracking. Only use carabineers that have a SWL—safe working load—or Kn rating stamped on the side.

### **ANCHORS IN TREES**

There are many ways to tie anchors, but they are almost all based on a few basic principles. When dealing with trees you really need to have a basic understanding of the strengths and weaknesses of each species. Softwood conifers are usually much faster growing than hardwood deciduous trees, and therefore you should be a bit more careful with your anchors if branches are involved. If you haven't already, take some time to get to know the characteristics of the trees where you are working. Take into consideration things like; bark thickness and type, sappiness, canopy health, trunk and root health, etc.

Generally, you should not use a branch as a main line anchor point. Use the trunk of the tree, as it is guaranteed to be stronger than any branch growing from it. Branches that appear to be strong and able to bear a load may have a difficult to see weak spot and may break as you step out on them. Don't even consider using a branch in any rigging capacity unless it is as thick as your thigh, with no signs of rot and lots of green healthy growth. Even then, it is always preferable to anchor lines directly to the trunk of the tree.

The specifics of platform setting for trees and blockades are covered more thoroughly in **Treesits and Platform Rigging** section, but for now we will cover the basics. To start off, Girth Hitching (or “choking”) is not an acceptable practice for anchoring climb lines. There are instances where hanging from a choked line is necessary (Girth Hitching up a tree or flag pole), but a choked rope should never make an appearance as part of a mainline anchor. The most basic and

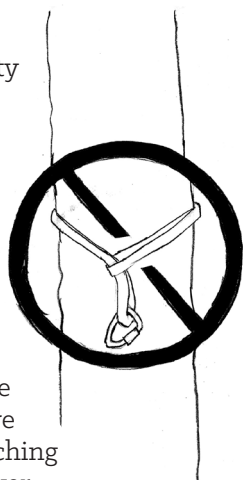

the most useful anchor is called a “Tensionless Hitch” or “High Strength Tie-Off,” depending on who you ask. “High Strength Tie-Off” is the preferred term, being that the title “Tensionless Anchor” can be somewhat misleading.

To anchor using a HSTO you simply loop the rope around the tree a minimum of 2 times—3 to 5 times if the tree is a smaller diameter—and tie the rope off to itself using a figure 8 on a bight or a follow through figure 8 and a locking carabiner or screw link to prevent any unwanted rope on rope friction. Take into consideration that the weakest points in any rigging system are the knots or tight bends a rope may go through. The HSTO creates no deviation in the mainline and the entire force of the load is passed into the wraps while our old friend friction holds the weight, leaving little of the load for the knot. Because of the friction and constriction of the line, it is only polite to protect the tree with a piece of canvas, and this piece of canvas will also protect your rope from things like tree sap. Make sure the anchor is not hidden and can still be visibly inspected. A protective sheath is not a crucial element of the anchor, so if you don't have one, don't worry about it too much.

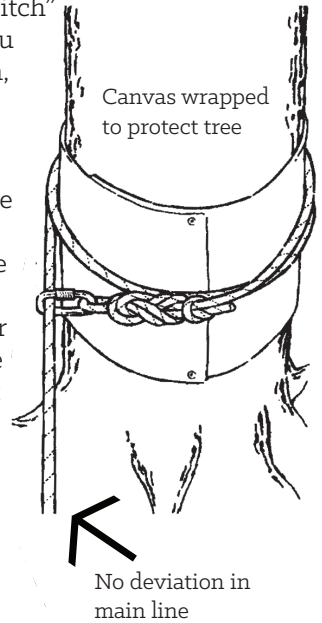

HSTOs are useful for everything from a main climb line on a tree to anchoring the ends of a tree to tree traverse. The HSTO will hold perfectly well if tied on a main trunk of a tree with no branches. If tied in this manner then the rope sag will place a greater amount of force on the connection point but as long as you are using a carabiner or steel link you will be fine. **The only other thing to remember is wrap the rope up if the force is pulling down and wrap down if the force is pulling up.**

Note the direction the rope is wrapped in the illustration for a downward pulling force.

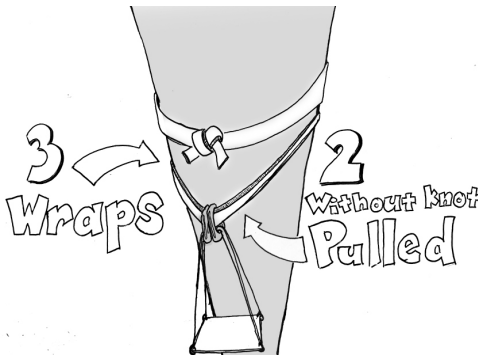

Another anchor that is a must know is the “Wrap 3 Pull 2.” You would use this anchor anytime you are clipping a line to the anchor, as in tree platform rigging, as opposed to tying the anchor with the line itself—as in a HSTO. Webbing

is the preferred material for a Wrap 3 Pull 2, but climb line can be used. Polypropylene rope (truck rope) is never acceptable as the main anchor for any structure. The 'wrap' is just how many times the webbing goes around the anchor point, and the 'pull' is how many of those wraps you are pulling with a load. You can do a wrap 4 pull 2 or wrap 5 pull 2, but after that the amount of wraps becomes redundant.

To tie the Wrap 3 Pull 2, pass the webbing around the anchor three times. Next tie a water knot or ring bend with the two ends—use a double fisherman's if using rope. You will now have three loops in front of you. Pull the two that don't have the water knot, letting the knot slide up against the anchor. This allows the knot to receive very little load bearing force, while the two other loops of webbing have joined forces to deliver over 8000lbs of strength. Make sure the two loops you pulled have an angle of less than 90 degrees to retain optimal strength. Use a locking carabiner or two opposite and opposed non-locking carabiners to clip your line into.

### INDUSTRIAL ANCHORS

There are plenty of blockade scenarios where support lines or climb lines are anchored to objects other than trees. Common anchor points are bulldozers, gates, cranes, truck bumpers, bridges etc... The possibilities really are endless. Be certain that whatever object you are anchoring to is strong and either really heavy or firmly attached to something that is.

With industrial anchors, it's also very important to provide adequate rope protection. Look out for sharp edges that may cut into the rope and use garden hose, fire hose, commercial friction savers, or other tough rope protection. Also, avoid or plan ahead for things that may be greasy, like vehicle axles. Hydraulic lines should also be avoided at all costs.

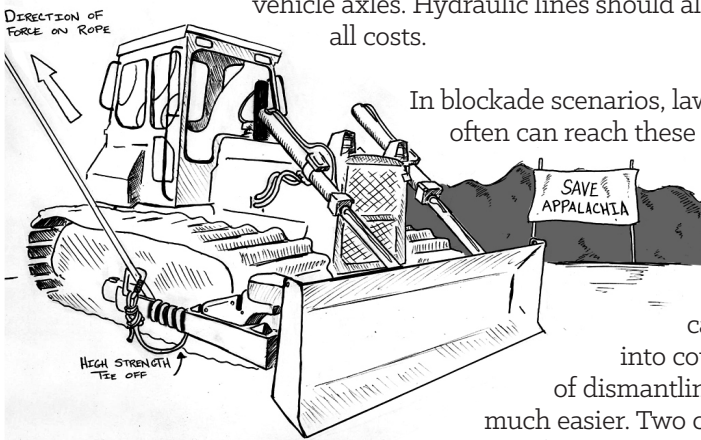

In blockade scenarios, law enforcement often can reach these anchors.

Therefore, using carabiners in your anchors that the cops can directly clip into could make the job of dismantling a blockade much easier. Two common

methods of tying these anchors include a figure 8 follow through and multiple wraps finished with half hitches. If you're tensioning a support line and then anchoring it, the figure 8 follow

through can take a bit more setup time, and it often helps to have a progress capture to hold the weight while the figure 8 is tied.

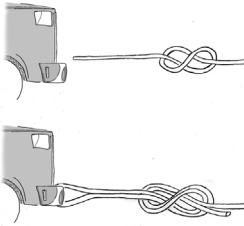

Using a wrap method, friction holds the weight of the support line as it does with the High Strength Tie Off. Take 4-6 wraps on your anchor point, depending on the girth of what you are anchoring to, then finish with at least three half hitches. This method has the disadvantage of more easily being untied by law enforcement, but can be super quick to deploy.

A variation of the wrap method is the Human Anchor. Make your wraps just the same, but instead of finishing with half hitches, tie the tail to a person. This method has been deployed with one person hanging off a bridge, and the other providing the final anchor at the top of the bridge. Occupations often last longer if more than one person is around when all the supporters get run off by the cops. While it sounds dangerous, remember the wraps will be taking most of the weight. Remember to practice this one with the rope you will be using on action day and something that mimics the anchor in size and material.

### DIRECTIONAL FORCES

To be a competent rigger you must understand load percentages and multipliers. One of the most direct applications of multiple anchor rigging in the forest defense context is tree to tree traverses. When rigging a traverse, you do not want it to be super tight. One big factor is tree sway. If two multi-ton trees are tied together tightly by a rope, then every time the wind blows and those two trees sway in slightly different directions the rope is getting shock loaded by a tremendous force. You

#### MULTIPLE ANCHOR RIGGING TENSIONS

ANGLE	INDIVIDUAL LEG TENSION
170°	1150.00%
150°	200.00%
120°	100.00%
90°	70.00%
0°	50.00%

do not want to have a rope traverse pulled too tightly, because as you see in the table, as the angle of the rope when loaded approaches 180 degrees the load on either anchor will increase dramatically. If a 200 pound person were to cross a traverse pulled to an extreme angle of 170 degrees that person would be putting 230,000 pounds of force on each anchor!

While you will never be able to make a rope that tight without some serious mechanical help, a good rule to follow is the 120 rule. You want all your multiple anchor rigging (traverses) to have an angle of no more than 120 degrees when weighted. Our 200 pound climber will put 100%

of their weight (200 pounds) on each anchor if the traverse angle is 120 degrees. However the same climber will put 400 pounds on each anchor of a 150 degree traverse. A saggy traverse is harder to cross, but a overly tight traverse can become extremely hazardous over time. Never use truckers hitches or mechanical devices to tighten traverses that are going to be left up for any amount of time, and always use high strength tie-offs.

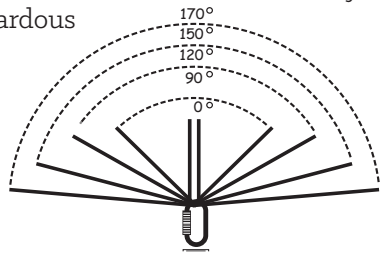

A similar principle is employed when talking about offset anchors (deviations). There are many instances when deviated anchors are employed in forest defense. The most common is using an offset anchor (a piece of rope anchored on a branch with a carabiner clipped to the main line) to pull the climb line away from the edge of a tree platform. Using an offset anchor can make it easier to access the platform, as the rope won't be against the edge. It also saves the rope from friction. The rope is anchored to the base of the tree (A) then goes over the branch (B) then dangles to the ground. Our 200 lbs climber (C) will exert 200 lbs force on the anchor at the base of the tree, but 400 lbs on the branch.

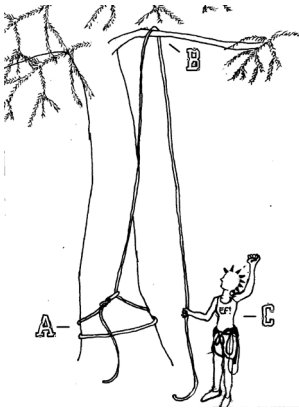

The big thing to keep in mind when using offset anchors is that as the angle of the deviation increases, so does the weight applied to it when the main line is weighted. It all goes back to 'Every action has an equal and opposite reaction'. When there are no deviations the forces meet 1 to 1, but since the rope is looped over a branch at a 0 degree angle you have two 200 pound forces meeting at the branch, generating 400 pounds of force on the branch itself. A sobering thought when you consider trusting twice your body weight to the structural

stability of a branch and the few inches of rope crossing it. Now go out and have some fun!

**ADDITIONAL RESOURCES**

www.cmcrecue.com, *Climbing Self-Rescue: Improvising Solutions for Serious Situations* by Andy Tyson and Molly Loomis, *On Rope: North American Vertical Rope Techniques for Caving and Rappellers* by Allen Padgett and Bruce Smith, *The Book of Knots* by Geoffrey Budworth & Jason Dalton



# >>> MOVING MOUNTAINS

Direct action often entails the moving of extremely heavy objects such as cars, boulders, logs, cement filled barrels, solid oak boardroom tables, and of course, porta-potties. Many of these objects can be difficult if not impossible to move with just your arms and legs. What follows are several techniques utilizing mechanical advantage and simple tools to help you lever, pry, winch, and roll really heavy objects into the path of industrial capitalism. Be aware of the tendency for this work to become a dude-fest. Be aware of who is doing the work and make sure it is accessible to all who want to participate.

## A LITTLE AT A TIME

Sometimes you'll have an object that is too heavy to lift all at once but you can still move a bit at a time by hand. In this case, lift one end up, slide some boards under it, and let it down. Lift the other end up and slide another set of boards underneath. Repeat this process on both ends until the object is at the desired height. Keep in mind the higher you go, the less stable everything is going to be. If your supports start to feel wobbly, stop!

## LEVERS

Levers are simply sticks, poles, beams or metal rods, pivoted on something—that something being your “fulcrum”—to raise a weight. A lever is usually used perpendicular to the ground, but a group of people can easily line up against the arm of a lever positioned parallel to the ground and against a weight. Tools that function as levers include hammers, peaveys, cant hooks, and pry/gravel/crow bars.



The physics theory of the conservation of energy proves that you can move a weight with a lot of effort from a short distance or with less effort from

a long distance. You apply this theory when using a lever. It allows you to move something heavy without a lot of effort, but you are required to move that something from a longer distance. That distance is the arm length of your lever from your fulcrum. Weight and arm length are proportional.

Say you want to roll a boulder that weighs 150 lbs. onto a road with only 50 lbs. of effort with an 8' lever. This means you will need a mechanical advantage of 150:50 or 3:1. You can do it if the arm length of your lever on the boulder-side of the fulcrum is one-third the length of the arm length of the lever on your side of the fulcrum; or 2' long on the boulder side and 6' long on your side. The longer the lever is, the less force you have to apply to move your object. Levers are also good for prying the edge of a heavy object up off the ground so that people can reach under to get good hand holds. Multiple levers can be used simultaneously on opposing sides of the same object in order to lift it vertically.

## **RAMPS**

If an object is too heavy to lift straight up, such as a concrete barrel into the back of a pickup truck, ramps can come in handy. The gentler the angle of your ramp, the easier it will be to move your object. But the gentler the angle is, the longer the ramp will have to be. So if your truck bed is 3' high and you use a 4' ramp you will be pushing that 600 lb. barrel up a 48 degree slope. That will still be pretty difficult. If you were to use a 10' ramp you would be dealing with a 17 degree angle; much easier. You can use boards, logs and metal poles to make a ramp. Piling up dirt at the desired slope and packing it down good is another option, though a lot of work. You must make sure that your ramp won't break under the weight of the object you are moving. You may need to put braces underneath your ramp to reinforce it. Logs, boards, rocks, and cinder blocks are all options for bracing.

## **JACKS AND COME-ALONGS**

Hydraulic jacks can be useful for slowly lifting or budging extremely heavy objects. You can get a jack that will lift up to 10 tons for about \$30. But it can only move that load about 10" at a time. So jacks are good

for moving very heavy objects short distances. Moving heavy items with jacks can be extremely dangerous. The jack needs to be on a firm and level base such as pavement, cinder blocks, or a solid board. You can also lift objects higher than the maximum reach of the jack. Once the jack is all the way up, stack boards, jack stands, or cinder blocks under the object you are lifting until you can't fit any more underneath. Make sure that they are stable and then slowly lower the jack so that your object rests on your boards or blocks. Once you are sure everything is stable, pull the jack out and stack some more boards or blocks underneath the object until your jack will fit snugly underneath it again with the jack fully collapsed. Jack it up again, and repeat the process until you have your object at the desired height. This can be

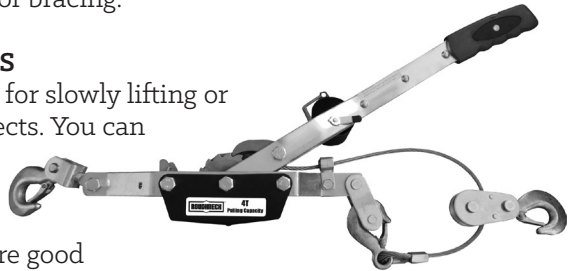

very dangerous; the higher you go the less stable everything will be. Use common sense and make absolutely sure that your supports will not break or otherwise collapse. If you have something vertical to brace a jack against such as a tree or wall, you can also use a jack to push heavy objects horizontally along the ground.

A come-along is a portable winch that uses a lever and ratchet system to pull heavy objects via a metal cable. Come-alongs are useful for moving heavy objects longer distances, like 15-20' at a time. Come-alongs rated for 2 and 4 tons are pretty common and can be purchased for \$30-\$40. To use a come-along along you need a solid anchor— like a tree, vehicle, metal posts—that can handle the strain of whatever you are pulling and a way to attach it to the object you are moving—chains, rope, or webbing that won't stretch. It is possible to put so much strain on a come-along that it will break. If it is becoming difficult to lever the come-along and your object is still not budging, you need to stop. If the come-along were to break, the cable, which is under incredible tension, can whip back at high speeds and injure or kill you. Come-alongs can be used in conjunction with ramps to move heavy objects to an elevated level.

## **WHEELS AND ROLLERS**

If it's possible to get your heavy object into a wheelbarrow, cart, dolly, or even on a skateboard or two, that can make your life a lot easier. For rolling over rough terrain, the bigger the wheels are, the easier the going will be. If you can't get your object on one of these contraptions, there are other options. For example, sheet metal workers will pry up half-ton sheets of metal, slide baseballs underneath and then roll the sheet metal across the floor on the baseballs. Similarly, mausoleums use marbles to roll coffins into vaults.

Another option is to use steel pipes or logs as rollers. Lay several pipes or log rollers in a row, parallel to each other. If you can't lift it, use a lever to pry your heavy object onto the first roller. Using people and/or a come-along, slowly work the object onto the rest of the rollers. Move the object forward, as rollers come out the back of your object, pick them up and move them to the front of the object to keep it rolling. You can also build improvised tracks by laying two sets of logs parallel to each other for your rollers to roll on. This can be especially helpful on soft or uneven ground. Be careful using rollers on a hill; there is a high likelihood of your load breaking loose and rolling into someone.

## **PULLEYS**

Pulleys are another easy to use device to make lifting a heavy load easier. If you want to raise something from the ground instead of having to get above it and haul it up, you can lift it from the ground with a pulley. Just

mount a pulley on a stationary object above what you are lifting and pull the thing up from the ground with a rope. This example does not decrease the effort required to raise the weight. However, raising the weight is easier on the body.

If you want to decrease the force necessary to lift something, you would attach a pulley to the object in addition to the pulley already at your anchor point, positioning the pulley on the rope between the anchor point for the rope and the object, so the pulley slides with the weight on the rope as you draw it near you. This system cuts the force required to move the object in half. But you will have to pull the rope twice as far to move the object the same distance. More complicated systems, which combine multiple pulleys, can be created to increase your mechanical advantage even more.

What is commonly known as a Z-rig, is a hauling system using three pulleys. This system distributes the weight of the object you are lifting onto the three lengths of rope woven through the pulleys. Therefore, only 50 lbs. of force is necessary to lift a 150 lb object. But you don't get something for nothing. Essentially, you will have to pull that rope three times as far as you pull a rope directly connected to the weight. The diagram below illustrates the physics at play.

$F_z$  = force needed to lift the object,  $F_l$  = force (weight) exerted by object being lifted,  $H$  = the distance the object is being lifted,  $S$  = distance you have to pull the rope to lift the object.

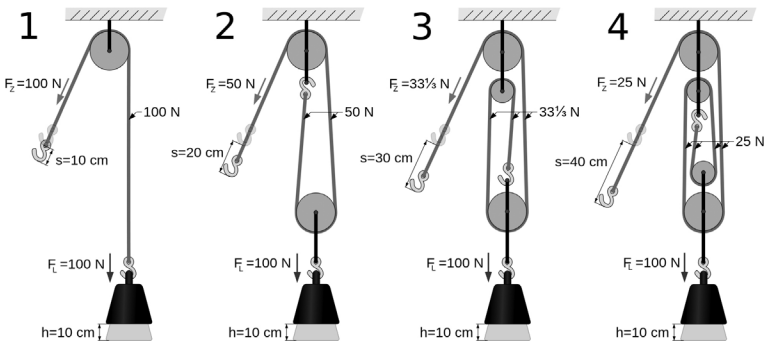

## BOUNCING CARS

Want to move a car out of your way, or into somebody else's way? Four or five people can pretty easily move a car by the bounce method. The rear is going to be lighter because it doesn't have the engine weighing

it down. If you just need to swing one end out, swing the back end. In unison start pushing down and lifting up on the bumper until it is bouncing good. Once you have a good bounce—the tires are hopping off the ground or close to it—start pushing to the left or right on each up bounce, depending on which way you want to go. Keep the bounce going. Once you get the rear end out a little ways, go to the front of the car and repeat the process. Slowly but surely, you can “walk” the car into the middle of a road, factory entrance, or whatever else you might want to block. If you have a larger crew you can have people on the front and back bouncing and moving the car at the same time.

## SAFETY

Moving heavy objects is inherently dangerous. Always wear closed toe shoes, and it is a good idea to wear gloves too. When moving a heavy object on an incline, never stand directly below it in case it suddenly breaks loose. Make sure you have plenty of room to maneuver around your heavy object in case you need to quickly get out of the way. Have good communication and a clear plan that everyone understands. Don't forget to lift with your knees!



Warner Creek road blockade, 1996-1997



# A LITTLE BIT COUNTRY

*Earth First!ers set up a slash pile to block a natural gas fracking operation in Pennsylvania, 2012*



# >>> THE ART OF HOLDING SPACE

## *Free States, Autonomous Zones, and Long Term Occupations*

Throughout the history of EF! and countless other movements, people have been able to take their protests to the next level and engage in long term occupations, actually creating spaces free of governments and police. Some call them free states, some call them temporary autonomous zones, some simply call it refusing to leave home. What these protests share in common is that beyond physically occupying a site to stop the bulldozers, these spaces become radical laboratories where new ideas and tactics are innovated, communities are created in a zone that is relatively outside of state control, and newcomers can quickly dive into a full blown direct action campaign. Free states are effective at protecting the places we love, while training new activists in direct action tactics and experimenting in new ways of living together.



The main encampment at the ZAD anti-airport occupation in France, 2012

Anytime we talk about defense of this land and occupation of land, we must also acknowledge the brutal history and legacy of colonization and the fact that countries such as the United States are currently forcibly occupying other places. For those of us who are settlers, we must remember that we are guests upon stolen land, and our potential for



establishing physical, liberated space is rooted in histories of indigenous resistance to colonization. The question of home and heritage is increasingly complicated as many of our ancestors were brought to this land against their will or came here seeking refuge from the exploits of capitalism elsewhere. However, as settlers on stolen indigenous land, we need to foreground a desire for indigenous consent to build anything on this land. The history of the domination of land extends further back beyond the colonization of this continent, through the enclosure movement for ownership of land in Europe and the colonization of that continent, to the very creation of civilizations. But as long as forces have tried to separate people from the land they are a part of, communities have risen up to resist. We must keep telling the stories of these legacies of struggle and take strength from the many generations on whose memories we build.

As a movement for reconnection with and protection of the land, Earth First!ers have naturally looked to indigenous communities in struggle for inspiration and practical skills in how to organize successful land-based defense. In early Earth First! history, campaigns in the 1980's built relationships of solidarity with indigenous groups centered in Arizona around struggles to protect Mt. Graham and the San Francisco Peaks, and it is clear that the free states that were initially incorporated into Earth First! wilderness defense in the Northwest drew on lessons learned from the reclamation of traditional tribal lands.

The first Earth First! free state style action was at Cahto Peak in northern California in the late 1980's. EF!ers built enormous slash piles, dug a 4' deep trench in the road and engaged in roving cat and mouse style blockades with loggers, shutting down operations for three days straight. Eventually the timber sale was canceled. In the mid to late 90's, EF! established multiple long term road occupations and free states throughout the northwest. Perhaps the best known is the Warner Creek Cascadia Free State in Oregon that existed from 1995-1996. This blockade consisted of a main camp guarded by a log wall, complete with a watch tower, cat walk, draw bridge, and moat, all conveniently placed on the only road leading to the timber sale they were fighting. People dug countless trenches, rolled boulders, and built slash piles all along the road leading up to the free state. In addition, the free state had two tripods, a bipod, several steel barrel lock downs, and three sleeping dragon style lock downs to really slow the loggers down. There's an excellent movie called *Pickaxe* that documents the Warner Creek blockade.

The Minnehaha Free State was another inspiring autonomous zone in the late 90's. Set up in Minneapolis, it was the first urban anti-road

occupation in U.S. history. On August 10, 1998, local residents—many of whom were Earth First!ers—and members of the Lakota, Dakota, and Mendota tribes started an occupation of the proposed Highway 55 that lasted for 16 months. This campaign used a combination of intricate and bold lock downs inside the squatted homes that were slated for demolition, and treesits in the adjacent threatened park land, resulting in the largest police action in Minnesota history to evict the occupation. Not only did the occupation stop the bulldozers for over a year, it created an autonomous zone in the heart of a major city that served as a training ground and an inspiration for activists both new and old.

Many of the free states of the '90's were inspired by the aggressive anti-roads campaigns going on in the UK at the time, which saw dozens of autonomous zones emerge in woodlands and fields that were threatened by new roads. These UK free states utilized everything from squatted homes to elaborate tree villages and even networks of tunnels underneath work sites that people lived in for weeks on end. The reclaim the streets model for demonstrations also comes from the UK anti-roads movement of that era.

The past several years have seen a number of other intense and exciting autonomous zones from within EF! and beyond. In 2006 Everglades Earth First! joined forces with Take Back the Land to establish Umoja Village on a vacant lot in Miami where they built living quarters for many of the city's homeless. The EF!ers lent their DIY know how to build pallet shacks, gardens, a water catchment system, and showers with local homeless people and community members in need, while defying police efforts to evict them. In 2009, a series of protests about college tuition hikes led to multiple day-long occupations on several college campuses in California. Interestingly, though many non-students were involved in the occupations, the demonstrations were eventually limited by the narrow scope of the protests and these experiments directly inspired what would become the Occupy movement.

In 2011, after weeks of rallying against anti-union legislation in WI, hundreds of protestors occupied the rotunda of the Capitol building, establishing an information center, a sleeping area, a medic station staffed by members of the Madison Community Wellness Collective, and food stations with meals for protestors supplied by local businesses. This occupation lasted for two weeks and saw over 100,000 people rally in support. Within a year of the Wisconsin Capitol occupation the concept of the autonomous zone spread like wildfire across the country under the banner of Occupy. Hundreds of cities saw people joining together to set up protest encampments in city parks where participants lived together, shared food, and organized actions through daily general

assemblies that were open to all. Many of these encampments fended off police evictions for weeks and some expanded to publicly occupy empty downtown buildings. In Oakland the Occupy movement escalated into open rebellion with riots and the first general strike in the US since 1949. The general strike shut down the Port of Oakland, one of the largest in the nation, and cost millions of dollars due to the stoppage.

Since 2011, a massive autonomous zone has blossomed in the French countryside in an effort to stop a new airport, called the ZAD—Zone À Défendre or the Zone to Defend. Majorly inspired by more than a decade of resistance against a high speed train line in Italy called No TAV, thousands of urban activists, anarchists, and autonomists have joined with local farmers to occupy the site of a proposed airport outside of Nantes. This autonomous zone extends over 4,000 acres of rural farmland where they have built cob houses, a communal kitchen and bakery, gardens, and even installed a pirate radio station. While some activists use treesits and lock downs to prevent evictions, farmers have blocked roads with their tractors, as black clad anarchists built burning barricades and engaged in running battles with the police through the fields and forests they are trying to protect. When the police evicted the zone in November of 2012 more than 20,000 militants, environmentalists, anarchists, and farmers answered the call to forcibly reoccupy the muddy autonomous region, and re-took the land after a day of burning barricades, clouds of tear gas, and conflicts with the police.

Meanwhile, members of the Unist'ot'en tribe are currently maintaining a camp in the pathway of a proposed gas pipeline through their traditional territory in northern British Columbia. Tribal members along with outside activists have occupied the site for over a year and successfully prevented pipeline surveyors from doing work in the area, while building traditional pit houses to live in and maintaining their hunting and gathering traditions.

The free state is an elusive and mysterious creature, whose habits and needs are poorly understood by even those most seasoned in predicting how conflict will unfold. Many a campaign has set out to create a free state only to have their blockade evicted within hours, while others have set up a basic blockade only expecting to last a day or two at best, and find themselves still holding it down months later with five times the occupants, and donations pouring in from all over the world. It is not exactly clear what makes it possible to establish a free state, perhaps the stars just need to be aligned correctly, but here are a few things to consider that might help you out.

## CLAIMING THE SPACE

The first order of business is to occupy a space for enough time that you are able to establish the basic infrastructure needed for a long term occupation such as shelters for sleeping and gathering in, a kitchen, and latrines. To maximize success, create a well-defined plan for the initial occupation with plenty of defensive measures and contingency plans in place. In the beginning, shelters are likely to be tents and tarps since they are quick to set up. If your occupation looks like it is going to last, more permanent structures can be built. For backwoods scenarios it may be possible to get all this in place covertly before the police are aware of what you're doing. In most situations, especially urban scenarios, you are going to have to figure out a way to simply hold the space long enough while you get everything set up. This may mean having enough people to overwhelm the police, using complex blockade techniques to make it too difficult to remove you, or simply moving quickly and taking them by surprise. There is no single recipe for how to keep your site from being evicted right away. Have conversations ahead of time about what you are collectively willing to do to defend the space. Usually police do not immediately evict a site because they are outnumbered, they don't have the expertise or proper equipment on hand, they fear the situation will escalate out of their control, or there is such broad public support for what you are doing that the cops have to worry about their image. There is also always the possibility that they don't consider your occupation an immediate threat and so they will just try to wait you out.

## KNOWING THE LAWS

Sometimes the laws on the books can work in favor of an occupation. For public property such as a city park or National Forest, make sure you know what agency or governing body oversees it and research the laws about camping or sleeping at such sites. One of the things that allowed the Occupy movement to flourish was that many cities did not have a law against sleeping in public parks, so the police couldn't legally evict the camps—though many cities quickly responded by changing the laws. The Umoja Village in Miami was able to forestall eviction thanks to a local law called the Pottinger Act which protects homeless people from being arrested for basic crimes of survival on public land—like eating, sleeping, shitting, and seeking protection from the weather. Having a friendly lawyer that can support you in the courts or can even just remind the police of what the laws are can be helpful. If you are occupying private property make sure you know who owns it. Try to find out to what degree the owners are engaged in maintaining the property and if it's abandoned, foreclosed on, or has unpaid taxes. All this information can come in handy when wrangling with courts or making your case to the media. See **Research** on how to dig up some of this information.

Ultimately these laws won't protect you, but they can buy you some time. If you are deemed a threat, at some point the authorities are going to either change the law or ignore it and attempt to evict you. This is especially true in backwoods actions where we can't rely on the presence of the media or other passersby to tie the hands of the police. Be aware that when the police can get away with it, they may do extra violent or dangerous things to clear an area.

## **SECURITY**

Free states are likely to be subjected to constant harassment by workers and police and ultimately eviction attempts. It is important to have 24-hour security in place so that you are not caught off guard by late night visits from drunk workers or predawn raids by the police. Nobody should ever do security on their own, always work in pairs. For backwoods actions where there may only be one road to approach your blockade from, station a security patrol far enough down the road that the free state will have time to get together if police approach, but close enough to communicate by radio, whistle, or horn with the main camp in the event of a raid. Part of your security plan should include obstacles for the police before they get to the main encampment, like a series of slash piles and other impediments in the road or a home-alone-style set of booby traps so that the police have to do a little work in order to actually get to the main blockade. If you have the numbers, have another security team that patrols the perimeter of the camp to keep an eye out for police surveillance teams or a sneak attack from other directions.

In urban situations a police scanner can be useful for listening for possible cues that the police are about to raid. Post people on nearby

### **PALLET SHACKS**

Tarps and tents work just fine for most free state situations, but with pallets you can build more permanent structures for your camp for next to nothing. Many of the homes at Umoja Village in Miami were constructed from pallets. The Minnehaha Free State in Minneapolis featured a 3 story "Star Lodge" that slept 18 people and was built mainly from pallets. If you have the time and access to trucks you can scavenge pallets—they should be the same size for ease in construction. If you aren't able to find them for free, pallets cost a couple bucks each. A shack can be built for about \$50 in pallets if you buy them.

Having some knowledge of construction is a big plus, and these instructions are just tips from experience, not an entire how-to for building a shack. As with everything—experiment and stay safe.

corners with radios or cell phones to communicate back to the occupation any information on police activities. If you know which police station the cops are likely to stage from, having someone posted there can be useful as well.

Having a loud signal that everyone knows means “Cops!” is very important, like a whistle, banging on a pan, or an air horn that is loud enough for all participants to here, even if they are far away on a firewood mission or building slash piles. Whatever you choose make sure it cannot be confused with any other loud noises that may come from camp. You may want to have different signals to distinguish between a couple cops paying a “friendly” visit and a hundred cops coming to evict you. Repeated false alarms can be extremely stressful and demoralizing. You should also, of course, have a plan in place for what to do in the event of an eviction.

Security also means protecting one another from violence or the threat of violence from others within the encampment. Although it would be great if our autonomous zones were actually free of hierarchical power and domination, we often bring the misogyny, homophobia, or other destructive behaviors from our culture into our “liberated” spaces. Having structures in place to keep each other as safe as possible and deal with serious conflicts when they arise is crucial to a continuing encampment.

### **STAY ORGANIZED**

It is important that the entire camp has some time during the day where everyone gets together and checks in. In some organizing models, this

Have the main supports of the pallets—the three largest pieces of wood along the outside edges and in the middle of the pallet that the thinner planks are nailed to—be parallel to the ground when the pallet is standing on its edge for the walls. With two pallets standing next to each other, the middle supports should be lined up. Lay a piece of wood across the middle supports and nail one end into each pallet. The two should now be fastened together because the wood is attached to the support of each pallet.

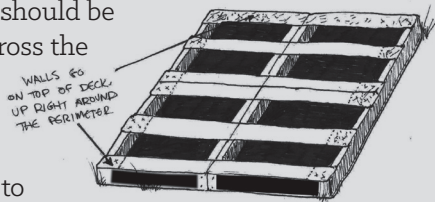

VIEW OF DECK FOR FLOOR  
4 PALLETS FASTENED  
TOGETHER, LAID FLAT ON GROUND

is called an assembly. It is a time to talk about what needs to be done and who is going to do it, and to resolve any other issues—though depending on the size of the group, it may not be an appropriate place to try to reach consensus or make certain decisions. For very large occupations it may be necessary to use a spokescouncil model with different affinity groups or working groups sending representatives to a daily meeting. In a lot of ways the day to day life of a free state mirrors that of an action camp. It may be helpful to structure your free state after such a model.

### KEEP PEOPLE OCCUPIED

Bad puns aside, having activities to keep all participants occupied is very important. If the police aren't bothering you all the time, things can actually get kind of boring around camp. Boredom can quickly turn to stagnation, infighting, and possibly the death of your encampment. Remember a free state has the potential to be so much more than a blockade. There are always more slash piles that can be built, and those trenches in the road can always be dug deeper, but what else can you accomplish with a group of people that are passionately fighting for the Earth? You can do species inventories of the land you are protecting, especially keeping an eye out for endangered ones. If the free state is accessible to nearby communities, you can host regular hikes for the public so that they can deepen their connection to the land you're defending as well as to the people defending it. You can build more permanent structures in order to make camp life a bit more comfortable. Or have an evening reading/discussion group in order to keep people's minds stimulated. In urban scenarios you could host daily

For the 90 degree corners make a diagonal shelf from a main support on one pallet to the support on the other wall. Nail a piece of wood across the corner and into the middle support of each pallet. Put them on as many of the supports as you can—it's these triangles that give your shack structural support. And shelves are great!

Easy siding can be made from stapled on waxed cardboard. Pallets can also be carefully dismantled and the wood can be used for siding.

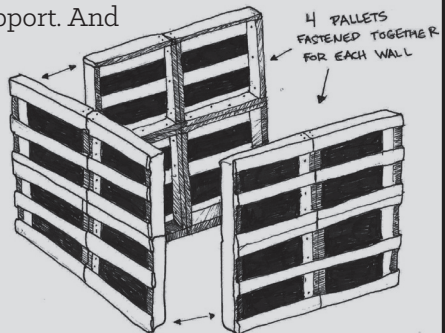

VIEW OF 3 WALLS WITH OPEN FRONT



workshops for the public to attend, or offer a free community meal once a day or week. Many Occupy encampments started up small libraries and free stores.

## PUBLICITY

Free states can be an excellent outreach opportunity as well as a place for people to learn new skills. Don't let this opportunity pass by. Figure out what your process is for bringing in new people. Which parts of your occupation will be open to the public? It can be tricky balancing the need for security with the benefits of including new people, but how else can your occupation continue to grow? Hosting community meals, hikes, workshops, and other public events are all good ways to invite new people in. Don't forget to send out press releases and utilize social media networks, too.

## SUPPORT CREWS

For backwoods free states, it is essential to have an urban support crew that maintains the occupation by getting and delivering food donations, recruiting new participants, raising money, and publicizing actions through mainstream and social media. These things are hard to coordinate when you are in the woods without electricity, computers, and phones. Even for urban occupations it can be helpful to have a support crew that lives offsite and doesn't have to deal with the daily stresses of maintaining an occupation. It also provides a meaningful way for folks to participate who may not be able to risk arrest or drop everything to go camp in a road for weeks on end.

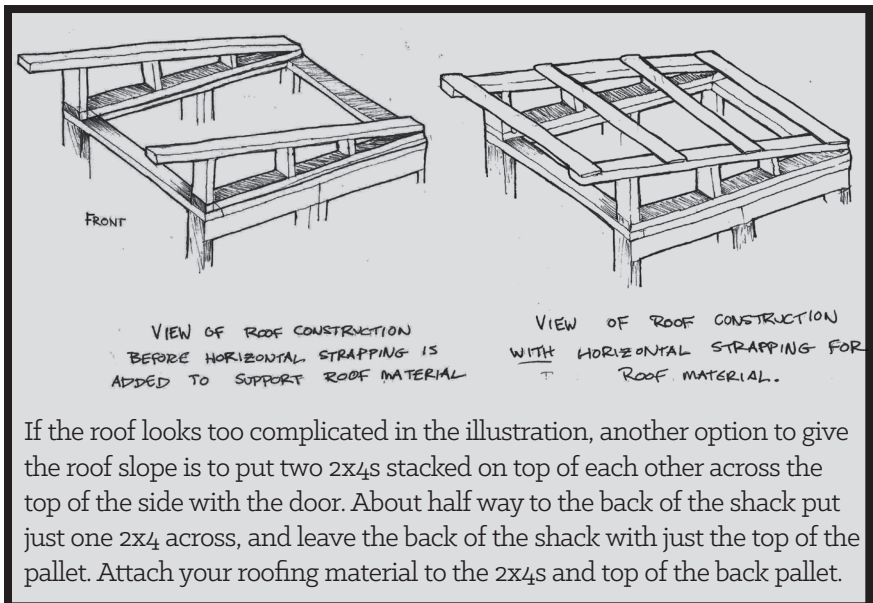

## **UNPREDICTABLE, UNCONTROLLABLE**

Creating a successful autonomous zone, free state, or encampment is indeed a mysterious combination of forces. It is unpredictable and uncontrollable, and we must also be. In May 2013, bulldozers arrived at Gezi park to remove a few trees as part of the government's development of Taksim Square in Istanbul. A few dozen friends responded immediately and stopped the trees from being removed, starting an encampment that would grow to become a weeks long occupation with hundreds of thousands of participants spreading fierce anti-police, anti-state demonstrations across the city that would change the landscape of Istanbul forever. All across Turkey massive demonstrations erupted against development, and the economy. Similarly uprisings spread across the cities and countryside of Brazil, and reflecting on the unprecedented resistance, friends in both places said the same thing; "No one could have imagined it. It came out of nowhere."

The roof needs something other than wood – some tar paper, a tarp, old billboard, etc....

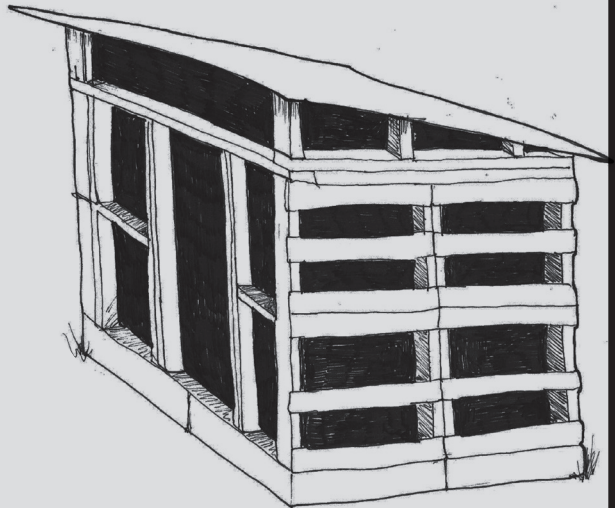

# >>> BACKWOODS ACTIONS

Distinct from urban actions, backwoods actions take place in the wilderness itself. They are the treesits, the cat and mouse games, the reconnaissance and scouting missions, the hunt sabotages, and the blockades that activists independently use to protect remote areas under siege.

For many years, activists have defended wild areas from logging, mining, development, and nuclear testing with courageous backwoods actions. What sets these campaigns apart is that self-sufficient groups of people are the only thing between the land and the industrial wrecking machines. In so many places, there is no legislation or litigation protecting the land. It is people alone, moving themselves quietly and carefully through the woods, confronting the destruction of the earth at its heart.

The risk of injury and arrest can be higher in backwoods actions. The helplessness and frustration you can feel when you don't know how to help someone when they're hurt or when you and your friends are being chased down by cops and loggers in the woods can be paralyzing. So, activists need to be prepared, well-practiced in backwoods skills, and familiar with the area they are defending.

If you or your affinity group is unfamiliar with navigating in the backwoods, plan some fun camping trips where you can get comfortable being in a remote setting and practice navigation, moving stealthily and survival skills, without the fear of getting arrested or accosted by workers.



## PERSONAL GEAR

This is a baseline for the gear everyone needs to have to survive at least an overnight stay in the woods. Sleeping bags are big, bulky and will slow you down, especially if you are being chased; they are only needed for extended backwoods trips—bivy sacks are a very nice luxury.

- **Water:** You can easily drink a gallon of water in a day if it is hot and you are hiking/working hard. Make sure to bring enough water with you. Bring a water filter, iodine, or other means of water purification in order to refill your bottles in the field. Don't drink untreated water!
- **Clothing:** Camouflage or earth-tone pants and long sleeve shirts are recommended no matter what conditions you will be in. They will protect you from the sun, thorns, poison ivy, nettles, etc. You will also be better camouflaged the more you are covered up with clothing that blends in with the landscape. In wet climates, wool or synthetic polypropylene layers of clothing will wick moisture away from your skin and keep you warm, even if you get wet. Cotton will retain moisture, creating a negative layer of clothing on your skin and chilling you. Remember, cotton kills.
- **Rain Gear:** a poncho, or rain jacket and pants, that blend with the landscape.
- **Boots:** Good, light to mid-weight, water-proof hiking boots with solid ankle support are essential.
- **Hat:** 85% of your body's heat is radiated from your head. A wool or fleece hat is key if you are expecting cool weather. In desert climates a good hat to shade you from the sun is essential.
- **Bandana:** Used for warming the face, wrapping a wound, marking a trail, signaling, or for face concealment.
- **Camouflaged Day Pack:** Think small, compact, and easy to run with. Containing: emergency space blanket, first aid kit, compass, topographical map, camping knife, water purification tablets/pump filter, water bottle, flashlight/headlamp with red lens, extra batteries, waterproof matches, needle and thread, disposable or digital camera, and a modest provision of compact, non perishable, high fat foods like energy bars, dried meat, dried fruit, granola, trail mix and chocolate.
- **Wrist watch:** To help you keep track of your distance covered.

## GROUP GEAR

Depending on what you're doing and how long you expect to be in the woods, you'll need a different set of materials. If you are scouting a site for an action or a base camp, you may want to bring extra maps to make notes on and GPS equipment, along with basic documentation equipment—like video and still cameras—and basic communications equipment—like two-way radios, cell phones, scanners, and binoculars. If you're setting up a blockade, make sure you also have all the climbing

gear and lock down equipment you'll need, along with all the tools you'll need to assemble your action and provisions to sustain you through it.

If you're setting up a satellite base camp, make sure you bring tarps, ropes, water jugs and animal-proof stash buckets, duct tape, bow saw/hatchet, shovel, stove, fuel, headlamps or flashlights, batteries, first aid supplies, sewing kit, concentrated soap, water purification tablets/pump filter, cookware and utensils, and waterproof matches or lighter. Much like the personal food you want to carry for a short or single overnight in the woods, for a larger group, pack compact, non-perishable, high fat and high carbohydrate foods like pasta, granola, trail mix, dehydrated vegetable flakes and mixes of hummus and tabouli, peanut butter (in a shatterproof container), dried meat, dried fruits, nuts, and energy bars.

If you need to stash food or gear in the woods, always stash your things in a water-proof and animal-proof plastic bucket with a tightly sealed lid. Duct tape any loose seals. When choosing a spot, select a clear landmark near the stash spot that's easy to describe and is in close proximity to the intended area of use. Camouflage it.

## **FIRST AID RESPONSE**

What injuries could we anticipate occurring in the wilderness? Blisters, cuts and deep lacerations, burns, nosebleeds, poison ivy or oak rashes, hypothermia, frostbite, shock, fractures, sprains or strains, dislocations, sunburn, fevers, colds and flus, diarrhea, snake bites, insect bites and stings, heat illness, choking, dehydration, and emotional burnout. It's most important for everyone to remember when dealing with any of these injuries to remain calm and keep the group calm. Then, reassure the injured person that you are going to help them.

What are the recommended responses to some of these injuries?

**Cuts:** Stop the bleeding and prevent infection and shock. For minor cuts, apply direct pressure to the wound with a clean dressing. If the wound is persistently bleeding, elevate it above the level of the victim's heart. Clean the wound and apply bandages. For major cuts, apply direct pressure. If excessive bleeding won't stop, apply a tourniquet. Pack the wound with clean dressings and seek professional medical care.

**Hypothermia:** In mild cases, immediately warm and rehydrate the victim. Rehydrate victim with water, not caffeinated fluids. Give the victim sugary foods for internal heat. Remove any wet clothing and insulate the victim from the ground with padding and from the cold with warm, dry clothing or direct body heat. Treat victim for shock.

For profound hypothermia, rewarming is best done by professionals in a controlled environment because victim may experience cardiac arrest.

**Shock:** If there is no visible head or neck trauma, prostrate the victim and elevate their feet to increase blood flow to the brain. Warm the person. Roll the victim on their side if they are vomiting.

Raise the victim's chest if they are having difficulty breathing

**Sprains:** Stabilize and compress sprained joint area with something like a bandana or ace bandage. Tighten shoes for sprained ankles.

Elevate joint. Apply cold pack and/or anti-inflammatory cream.

Administer pain killers.

**Fractures:** Control any bleeding. Immobilize fractured area by applying structural support with splints, towels, and blankets.

Administer pain killers. Care for shock.

**Dehydration:** Always carry sufficient water and drink regularly.

Rehydrate slowly with room temperature water.

## FIRST AID KIT SUPPLY LIST

- **Comprehensive first aid manual/guide**
- **One - Emergency Space Blanket**
- **Two- 40" triangular bandages**
- **One - 2"-3" roller gauze, three - 3"x 4" Telfa Pads, one - 8" x 10" Surgi Pad**
- **Three - 2" gauze compresses, six - 4" gauze compresses**
- **Six - 1" bandaids, five - butterfly bandaids, eight- steri strips**
- **One - elastic 3" Ace bandage**
- **Two - 3"x4" moleskin pads**
- **One - roll waterproof tape**
- **One - pair tweezers**
- **Two - packets instant hand warmers, 1 - cold/ice pack**
- **Six - large safety pins**
- **Six- pain reliever tablets, six - anti-histamine tablets, six - antacid tablets, six - salt tablets with dextrose**
- **One - tube antibiotic ointment**
- **Four - antiseptic cleansing wipes or small container of antiseptic solution like Betadine**
- **Homeopathic and Herbal remedies**
- **Paper and pencil for emergency rescue info**

## LOST IN THE WOODS

What do you do if you become separated from the group or get lost?

Remain Calm. Think backwards, retracing your steps in your mind, pinpointing landmarks, and remembering the time you have taken to get to where you are. Look at your topo map and compass. Unless you are 100% sure of where you need to go, stay put and someone will find you.

Prepare a pine bow shelter for yourself or locate a dry warm area—a hollowed out snag is great—to possibly stay overnight and mark it for the search party. Pile 1-2' of dry forest floor debris/duff over you, and stuff it inside your clothes for insulation. Gather water from gently flowing sources of water, not too fast, not dead still. Natural springs from the ground are best, but always purify if possible.

## **HOW TO MOVE IN THE BACKWOODS**

### **Navigation in the Wilderness**

Before you head out, check the weather. While you can never totally trust the forecast, it can give you a reasonable idea of what temperatures to expect and the amount of rain or snow you might encounter.

Move in full awareness of your surroundings; pay attention to where you're going and where you've been so you don't get lost.

Familiarize yourself with compass navigation. If you're not sure how to use it well, at least it can always help point you north.

Watch the sun's cycle throughout the day. It rises in the East, sets in West, and in the northern hemisphere, tends toward the southern part of the sky in the winter.

Follow and remember landmarks like peaks, ridges, roads, trails, trees, snags, stumps, meadows, wildlife trails, water courses, and soil types and textures.

Use a topographical map to help navigate the terrain. The superimposed grid on the map usually marks one square mile within each square, and the top of the map points northward.

Use a watch to time the distance you travel. Keep track of your distance by using a watch and correlating the minutes you travel with the speed at which you are traveling. A person hikes at an average speed of two to three miles per hour, though bushwhacking through rough terrain can easily reduce your speed to one mile per hour or less.

### **Movement Techniques**

Move with full awareness! Like a deer, move cautiously; stop, look, listen, and wait. Use all of your senses to their fullest. Tap into that sixth sense of intuition we all have; when you feel something is wrong or right.



As a group, move single file, spaced approximately ten feet from each other to effectively hear and see everything around you and avoid bumping into each other if you are ambushed and have to bail quickly in any direction.

Blend into your environment. Camouflage yourself in clothing and in movement. If you are detected, most often it is your movement and the noise you are making while moving that gives you away. Stop and fade into your environment. Crouch and freeze behind a bush, under a log or between rocks. Climb a tree or cover yourself in duff and lay motionless on the forest floor; watch, listen, wait, and escape when the coast is clear.

Move silently. Use a verbal signal to get the group's attention. Mock animal sounds like squirrels, ravens, or owls work best in the woods. Only raise your voice if you have to alert the group of an emergency. Avoid making loud, high pitched sounds. Clanking metal, like carabiners, sloshing water in bottles, and especially sticks snapping, are all sounds that travel far and wide. Low pitched thuds dissipate quickly.

Crouch at the knees, not the waist, to keep your back straight and head up for full observation. Raise legs up, out, and down like a soldier to avoid tripping, and enable you to focus more attention on things around you.

Roll your feet heel to toe, compressing weight gradually to avoid snapping sticks and making loud steps. Moving slowly on the balls of the feet is also very quiet.

If traveling in a group, use the buddy system. Whenever possible don't send people out on their own away from the group.

Move from one point to the next, either as a group, or in 1-by-1 or 2-by-2 relays. Choose a path as far ahead as you can see.

Use hand signals to stop—raised fist/flat palm—slow down and communicate. Keep an eye constantly on one another and the group as you move, looking for anyone's signal.

Always bail uphill and scatter from the group with your buddy to disorient those pursuing you. Rendezvous 150 feet or so away in a half or three quarter circle point from the spot you dispersed to regroup and survey the scene.

Have contingency plans well thought out in advance. Select rendezvous spots and meeting times. Schedule pick up times and places. Establish signals or indicators for your group that mean specific things—like piled sticks, rocks, or arrows drawn in the trail.

Know when to call an action off for whatever reason; whether someone gets seriously hurt, the security is too high, the weather turns bad, or whatever. Chances are you will be able to regroup, increase your preparation, and hit your target twice as hard the next time.



Earth First!ers at one of the many slash piles accompanying an aerial blockade that shut down an active fracking site in the Moshannon State Forest after the Earth First! Rendezvous, 2012.

# >>> CAT AND MOUSE

- + Does not require a lot of gear or money
- + Can be planned relatively quickly
- + Can create strong bonds in your affinity group
- Can be very dangerous
- Not always good for trying to get media
- Only a stalling tactic

Technically by law, work is not allowed to proceed on many job sites such as mines or logging operations when non-workers are present on the site. This rule can be used to our advantage to shut down work sites with a game called Cat and Mouse. Cat and Mouse is basically going for a run or playing tag with friends. Just gather up your affinity group and go for a run around a timber sale that is being logged, or on an active construction site, and instead of pretending to run from zombies as motivation, run away from real life workers and cops. Cat and Mouse is sometimes not the most inclusive of tactics—folks who are on the ground frequently need to be fast and knowledgeable about backwoods survival—but it can be an effective action for stopping work for the short term.

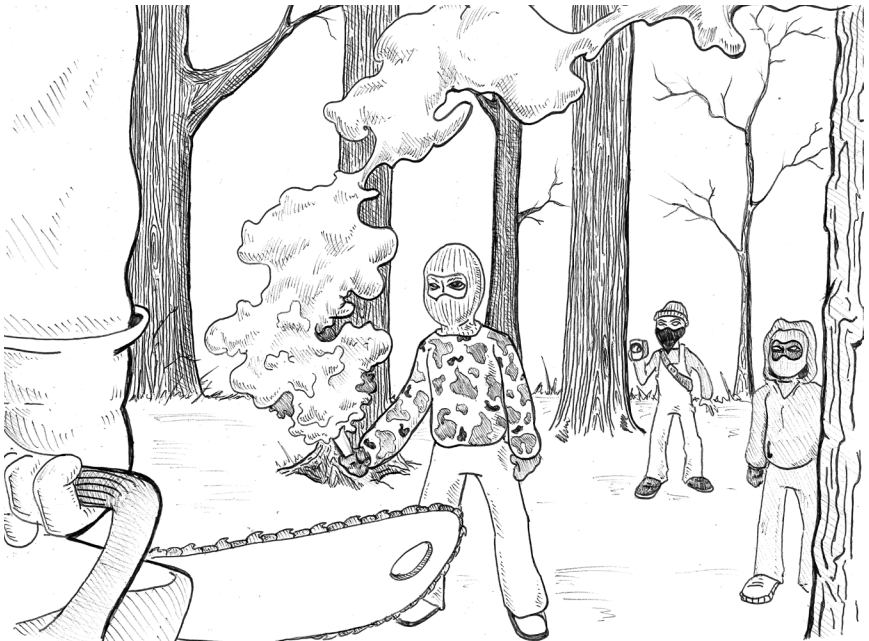

***The needs for a Cat and Mouse action are minimal, but important:***

- **An affinity group of at least 5 people** – though with more folks on the ground, more work can be stopped. At least one person should be off-site for any jail support or pick up needs and to publicize if workers are not stopping while people are in dangerous positions. Split into at least two groups on site with everyone buddied up for safety. This allows more area to be covered, and having multiple buddy teams provides the opportunity for de-arresting if anyone gets caught.
- **Maps** – topographic if possible—of the area for each person, a compass, and a day bag with snacks, water, and weather appropriate gear in case any team has to run off into the woods and cannot be rescued for hours. Use the maps beforehand to plan escape routes and pick-up locations. Know where there is cell phone service and if there are local houses that are either empty or friendly for possible meet up locations.
- **Cameras** – both video and still—are helpful for documenting the scene. If workers continue running machines or chainsaws with people present, video can be used for lawsuits and OSHA reporting. The media is also usually more than happy to use such exciting footage.

Before taking part in a Cat and Mouse action make sure to plan what the tone of the event will be. Is this a time to create as much chaos as possible by running around and being wild and somewhat dangerous? Is the campaign ready for a bold, daytime occupation involving kids and folks who are less able to make a quick get-away? Is the plan to be a distraction while a longer term blockade gets set up? As with any action, being intentional and strategic before it all begins is vital.

Knowledge of the local laws is helpful, from legal property lines, to work site regulations, and what the possible interference charges are if you get caught.

With this tactic it is extremely important to be aware of safety. Those who are on site need to be constantly paying attention to everything that is happening—where the workers are, what machines or saws are still running, where any hazards are. Mine sites are especially dangerous due to unstable rubble, cliffs, and the regular use of explosives for blasting. Anything from a sprained ankle to serious bodily harm or death is possible with Cat and Mouse. There can never be a guarantee of anyone's safety when activists are relying on workers to stop running machines or the police to force them to stop. Be careful!

# >>> HUNT SABOTAGE

Everything from pigeons to bison to bears, wolves, coyotes, snakes, alligators, geese, sharks, mountain lions, whales, sting rays, big horn sheep, prairie dogs, and foxes have been hunted, chased, poisoned, blown up or trapped. Predators have been especially targeted by hunters, farmers, and governments—U.S. Fish and Wildlife, Animal Damage Control—because of either perceived threat to humans and human interests, or the mystique of killing a fellow predator. Hunt sabotage has long been an effective tactic to stop, inhibit, or draw attention to this massacre.

Hunt sabs often mean direct intervention like blockades, harassment, and propaganda. But sabotage alone does not stop a hunt forever; an entire campaign is typically needed to ensure it is canceled for good. In addition to saving individual animals, the hunt sab can use the media to draw attention to a particular hunt.

There are several ways to effectively sab a hunt, and the choice of tactics depends on the desired result, the animal being hunted, the terrain of the hunting area, local laws, current public perception of the hunt, and the number of people in your affinity group. Ideally the hunt sab serves to deter hunters from participating—if the hunters know beforehand that they will have a difficult time, they may not even bother trying.

When planning to head out to the wilderness to sab a hunt, it is extremely important to remember that hunters are armed. If you come in contact with a hunter do not make any fast or aggressive movements. Be ready to stay calm and de-escalate the situation as well as you can.

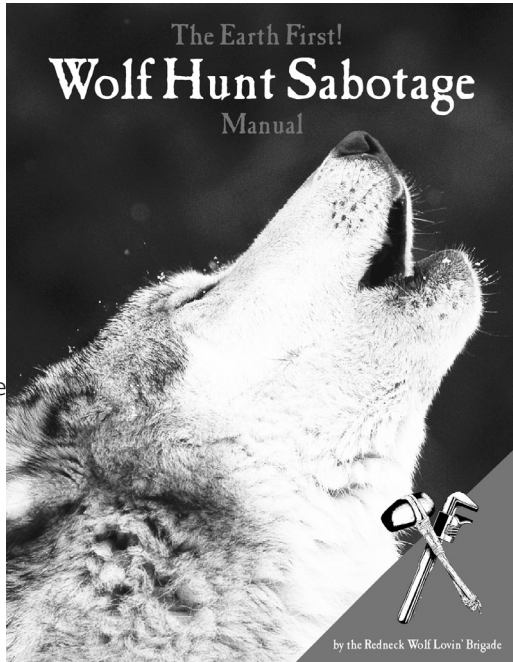

The Wolf Hunt Sabotage Manual received widespread national attention in 2013—the first year wolves were hunted in several states in the US. Download a copy on the Earth First! journal website.

## HOW TO DO IT

Research the species you are trying to protect. The sabotage tactics will depend heavily on what animal is being hunted. To sab the sandhill crane hunt in Arizona, activists learned that the cranes were skittish about landing, and that the hunter's guns only had enough range to kill the birds when they were landing. Activists were able to hide in the field a safe distance in front of the hunters and flash reflective material to spook the birds into not landing—thereby flying too high to be shot. Someone wearing blaze orange and shining a flashlight into the sky reportedly works well to warn ducks, who have keen eyesight. Staying near the hunters will increase the amount of human scent in the air, and many prey animals have a sharp sense of smell. Knowing when the animals typically sleep can help decide when to be out and about protecting them. Be conscious of what the animal will respond to best—will your loud voice scare it into a hunter's range?—and pick the tactic most suitable.

Every state has an agency that publishes regulations for the hunting season. It is usually easy to find out opening and closing dates, how many permits have been issued, and other hunt specifics.

Regulations can frequently be found at the agency office, or at chain sporting goods stores, some big box stores, smaller hardware stores, online, or at the library. Consider applying for a hunting permit. If it is a special hunt there will be a limited number, and getting a permit means one less hunter. This also provides an excuse to be in an area that might be open only to hunters.

And being a terrible hunter crashing around and spooking animals can be a hunt sab all on its own.

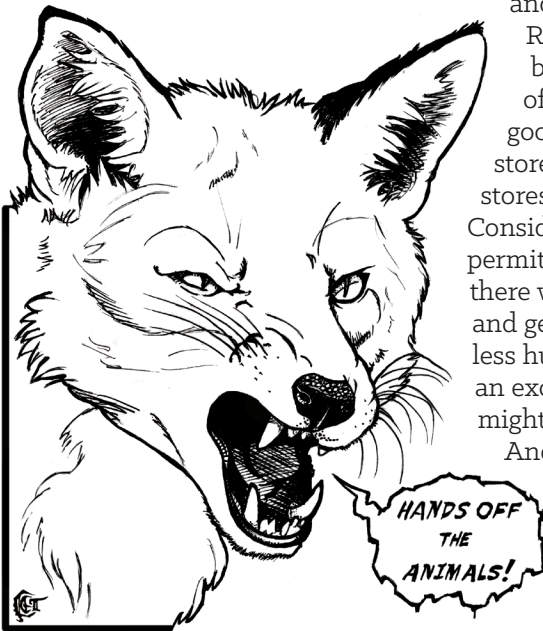

Make sure to get maps of the area—both road maps and anything available for the backwoods if needed. Scouting beforehand can come in quite handy. As with any action, having an affinity group that knows each other and knows how far everyone is willing to go is a great idea. Make sure to talk about the



goals of your action—to save as many animals as possible, to cancel the hunt forever, to document hunt violations, to gain media attention, etc. The number of people needed to participate will vary with each campaign, but plan on having at least two buddies in the field and one other person in a safe place who knows their location and can contact the media.

Be prepared to do some media work—have a press release ready, get spokespeople practicing the talking points, prepare visuals, and know the security needs of the group. Bring along equipment to safely document your activities. Also be ready to film hunters breaking laws or acting cruelly. This video does not have to be used for collaboration with the police, but can be a great help in showing the public the brutality of some hunters.

Be prepared to use walkie-talkies, cell phones, C.B. radios, and scanners to stay in touch with your affinity group and to monitor hunters and possible law enforcement activities. Other useful supplies might include: noise makers (air horns, whistles, instruments) smoke bombs or flares, personal alarms or “screechers,” urine (human or predator) to scare animals away, mirrors or cds with reflective surfaces, and hand tools to dismantle traps or snares.

## **LEGAL ISSUES**

Depending on how publicized and controversial the hunt is, have a lawyer ready for criminal defense if needed. Interfering with a legal hunt is illegal. Typical charges include trespassing, disorderly conduct, resisting arrest, conspiracy, and interfering with a legal hunt. Check out the laws in the area of the hunt to know what to be prepared for.

Direct aid is not selfless; it's not charity. It is about finding the overlapping points in struggle where one person or group might be able to offer something that someone else has less access to. Direct aid is supporting other folks' resistance; it's about broadening our view of who is a part



# >>> DIRECT AID AS DIRECT ACTION

of the projects we're building. Don't forget that resistance can exist in a multiplicity of forms, moments and aspects of life, like organizing reading groups within prison walls or refusing to leave your home even though the land continues to be poisoned by mining companies.

We benefit from supporting other folks and learning about their experiences. Recognize the ways that this work is self-serving. Accepting that everyone involved benefits from direct aid is the first step to breaking from the condescending charity models of aid. Being connected in this way to others in struggle may be the inspiration to keep going, the reminder of all that is possible within the limitations of a terrible world.



Volunteers with Common Ground help clean up the toxic aftermath of Hurricane Katrina, 2005.

## **IDENTIFY NEEDS**

Don't go charging into the situation thinking you have all of the answers. Perhaps actually the place to begin is by looking to your own community before jumping into another place and context, by asking, what do folks around you need? A lot of the bigger radical direct aid groups, like Black Mesa Indigenous Solidarity, No More Deaths, and the International Solidarity Movement have been started by people living in the "affected area." Remember, it's not enough to simply approach a situation with humility.

If you're organizing outside of the place where you live, seek the opinions of those who live in the area who may already be engaged in resistance. Listen more than you speak. Learn to recognize where your presence is appropriate. Have folks asked for help in a specific way? For instance, the Black Mesa clinic was inspired by a resident asking supporters if they would come do body work and herbal care. Together, think about what can help people do the thing they are already doing better or more easily, and try to find the resources you may be able to gather that would assist them. Effective direct aid can require a slow pace and intentional information gathering.

Think creatively and outside the system. For example, after spending a few weeks in a border town where dozens of people were deported daily after being stripped of their belongings, one person identified two main needs: that people needed access to phone calls and access to money. The aid set-up included a free and protected phone service and a free money transfer service through a personal bank account where people could withdraw money without IDs and without the 15% surcharge of Western Union.

### **GAIN THE NECESSARY SKILLS**

Effective aid requires a commitment to providing resources that are within your ability. If you do not have the skills to meet the needs of a community you should look for people with these skills within the community, recruit or learn from others who have them, or reassess how you are going to engage in your aid work. Imagine an indigenous solidarity group is having a yearly wood chopping to distribute firewood to elders in the area, and they have asked people to either come themselves or send money to be able to pay a young native person from the area an hourly wage to do the same thing. If chain saw or ax skills are not in your personal arsenal, it would be better to start fundraising. If that particular wood-run experience is important to you, get the know-how together to be able to contribute solidly. If an aid effort is ill prepared it can often create more problems than it helps to alleviate.

### **GATHER RESOURCES**

Use any footholds you can access within the existing social structures to redistribute useful resources to the best of your ability. Scamming corporate stores, utilizing resources from a few sympathetic people with a lot of money, or a vast support group of sympathetic people with a little money are good places to start. A non-profit may finance something direct and useful while not micromanaging too much, or allow their reputation to be used for causes that wouldn't garner as much widespread public sympathy. Fundraising through a homeless shelter for harm-reduction needle exchange programs is a good example of this.

## **GET THE WORD OUT**

Many direct aid scenarios involve supporting communities that are isolated either geographically, socially or politically from mainstream society. Use your social networks back home and around the country to get the word out about what is happening on the ground in the community you are supporting. Recruit people who are familiar with working with the press and social media to aid in media work.

## **AVOID THE PITFALLS**

Don't generalize the groups you're working with or depict them as victims or voiceless. Don't appoint yourself as their spokesperson, guardian or savior. Respect the complexity of every situation by addressing individuals and their actions, rather than tendencies within groups of people or contexts.

Avoid a singular focus on traditional definitions of conflict zones. Recognize the wars waged in your community. A rideshare network for people without vehicles who want to visit family and friends in prison is an excellent example of this, and no less relevant than dramatic examples of crisis aid such as disaster response.

Don't push yourself to the point of being a hindrance. If the emotional strain of your work builds to the point that you no longer function positively within the scenario, be honest with yourself. Reach for whatever works for you to build your inner strength, and find a way to take the time to do so. Recognize that your contribution will be greater after a little recuperation.

# >>> ACTION CAMPS

Is your community having a lull in exciting action or could your group use some fresh energy? Perhaps it's action camp time. The action camp is a multifaceted tool that has the potential to get new folks involved, kick off a new campaign, hone skills of experienced activists, and plan kick-ass actions that scare the pants off your targets. Here are a few things to consider when planning your next action camp.

## EARLY PLANNING STAGES

- >> Set some attainable goals for camp
- >> Determine who your target participants are—local community, regional EF! Groups, other local activists groups, college groups
- >> Find a space and date that matches the needs of your target participants
- >> Promote the camp through channels geared toward target participants
- >> Never underestimate the power of personal invitation—especially phone calls
- >> Registration forms can be helpful to assess participants needs and preferences for things like housing, child care, and food

## COMPONENTS OF A SUCCESSFUL CAMP

There are a lot of different components to an action camp—too much for any one person or group to oversee. Spread responsibilities around to avoid forcing everyone into endless meetings about every minute detail of the camp. It works best to establish working groups or individuals to bottomline the different responsibilities of the camp. These working groups can work autonomously on pulling their part of the camp together, while being accountable to the group as a whole. To maintain group cohesion and communication, bottomliners of each working group should have regular check-ins before and during camp to make sure nothing falls through the cracks.

## WHEN PLANNING YOUR ACTION CAMP, CONSIDER:

>> Working Groups or individuals focusing on particular aspects of the camp including: Outreach/Media, Registration, Kitchen, Scheduling, Housing, Childcare, Conflict Mediation/Decompression Spaces, Action

Planning, Welcome Tent/Security, Info Table/Library, Medics, Separate Camping Options or Decompression Spaces—like for People of Color, Women, Transgender/Gender non-conforming folks

- >> A safe secure space that is welcoming to participants, including adequate spaces for workshops and full group meetings/presentations, as well as a welcome table or tent
- >> Experienced workshop leaders—get in touch with the EF! speaker's bureau if you want to find trainers near you
- >> A prepared schedule including 1-2 hr workshop blocks with short breaks in between them, meal and snack time and some scheduled free time for people to meet one another and begin to process the things they're learning
- >> Delicious low cost/no cost food to keep people's energy and morale up
- >> Housing or tent camping—be as accommodating as you can for people with different needs
- >> A place for folks doing 24-hr security/welcome shifts to keep camp safe
- >> Time set aside for action planning
- >> A social mixer activity for folks to meet new people/fun evening activities
- >> Plenty of information on the issue/s your group is working on
- >> Welcome packets with info about your group/campaign, schedule, explanation of common consensus terms and hand gestures, other information that offers a sense of place to folks not familiar with the area—this could include a brief history of indigenous struggles and the colonization of the land you're on, specific information about plants or animals of the area, and context for past local struggles
- >> Post the schedule of workshops, events, and meals during camp on a large white board or butcher paper in a central location
- >> Minimize use of abbreviations and acronyms to better welcome new folks
- >> Set aside time for making art for the post camp action

As you organize the action camp, be aware of the ways that socialized hierarchies affect both your core group's dynamics and how camp attendees will feel. It's easiest to challenge ourselves, to push ourselves

courageously beyond what we thought was possible when we feel like those around us believe in our capability. For instance, be conscientious of the ages, races, genders, etc. of those doing trainings. Take this as an opportunity to deepen ties with other groups working on the same issues—especially groups with an environmental justice focus or groups incorporating a social or economic analysis. Ask your group questions like: Are roles being filled along predictable gender lines? Who is making announcements? Are a few people acting as the spokespeople for the organizing group?

### POST CAMP ACTION

Post camp actions can be very stressful to organize because lots of newly acquainted folks are often working together on a short timeline. Not all camps must have a planned action afterward, and sometimes a mock action, rather than a poorly planned or ineffective action, will better prepare participants for the next throwdown. There are things to consider when planning for actions after a camp that have lots of folks working together for the first time. See **Anatomy of an Action** for complete information on planning a kick-ass action.

Start your action planning well before camp, but don't create an entire action that camp participants have no agency in. This means have your target picked out and well scouted in advance so you are free to concentrate on workshops and planning dialogue during camp. Find a good information sharing balance where everyone has the details necessary to make informed decisions for themselves, but details that would compromise the action if leaked to the cops are kept on a need to know basis—unfortunately we must expect that infiltrators could be at the camp.

It has been useful in the past to divide folks into groups based on risk level: red being highly arrestable, yellow being somewhat arrestable, and green choosing to take no risk of arrest. Designate people from your organizing collective to meet with the red, yellow, and green groups to fill them in on action details and help them develop plans. Make sure everyone participating in the action has a buddy or affinity group and that there are plenty of roles to be filled. Make sure there is good

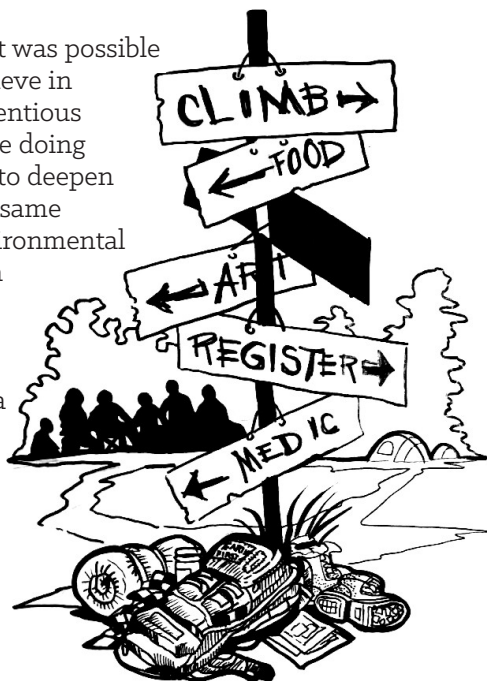

communication between the red, yellow, and green groups, so that they are working in support of each others' efforts and not creating problems for each other.

Post camp actions are often people's first exposure to direct action. It is just as important that these actions are empowering and participatory to new people as it is to shut down that work site for the day. Plan your post camp action with this in mind and make sure that all participants are able to participate in a meaningful way. Emphasize that all roles are equally important to help combat the tendency to elevate the people risking arrest to celebrity status. As much as your action scenario allows, keep the red, yellow and green groups as close together as possible. There is safety in numbers, and big crowds are good for building morale. It is also far more empowering for all the groups if they can see each other in action rather than being separated far away—just make sure that the green group is somewhere that isn't trespassing, since they don't want to be risking arrest.

Also, remember to prepare an infrastructure plan for during the action ahead of time. The night before the action can be very stressful if people are up all night finishing last minute details. Will a few folks need to stay at the camp during the action to keep it secure? Will the kitchen prepare food ahead of time for everyone to eat during the action? Will someone be available to scout the camp exits before the action departure time to see if cops have the routes staked out? How will you coordinate rides and give people directions without giving away the location? Think about using one or multiple meet-up points en route to the action, especially if timing is critical. Plan a bathroom and fuel stop partway along so that everyone arrives ready to go. Designate a ride coordinator who bottomlines making sure everyone has a ride and drivers have directions to the action and know how to find parking at the action site.

Finally, make a plan for a post-action debrief. If people are likely to get arrested, this can also be a time to gather bail money and keep folks updated on the legal situation. The debrief location should be a comfortable place for a large group to talk, away from the site of the action, maybe with food and drinks. The post-action debrief is a crucial part of learning from our mistakes, celebrating our victories, and keeping energy levels up so we can continue to fight.





# S

## YOU'RE GONNA LOCK TO WHAT?

*Croatan EF! locks down at the NC Dept. of Natural Resources  
headquarters in Raleigh, 2012*

# »»»RAIL BLOCKADES

**NOTE:** *Train blockades are extremely dangerous. There are at least two cases of people being run over and losing their legs because the train did not stop. You must take extreme caution when doing train blockades. Safety should come before all other considerations. The following advice will not ensure your safety. Trains will kill you if you don't keep your wits about you.*

Trains carry billions of dollars worth of raw materials and finished goods across the US every day. While extremely dangerous, train blockades can be a very effective and spectacular way to get your message out while costing your opponents lots of money in

lost production. In the US, train blockades have historically been few and far between, though they seem to be growing in popularity. In 2012 Katuah EF! and Radical Action for Mountain Peoples Survival used tripods and lockboxes to block a coal train from entering a Duke Energy coal plant in NC. In 2013 Maine EF! twice blocked trains carrying oil from the Bakken fields in North Dakota with body blockades. That same year activists in Montana were able to shut down the main line that exports coal to the West Coast by simply holding a sit-in between two sets of tracks. Rail blockades are a common protest tactic used by First Nations people in Canada, often deployed in solidarity/retaliation after police crackdowns on fellow indigenous protesters. During the height of the Idle No More movement (Winter 2012/2013), First Nations activists crippled much of Canada's rail traffic with coordinated blockades.

## TRACKING TRAINS

Tracking train activity will help you stay safe. The more you know about the train schedule in general, the better. Being informed about the frequency of your target train and the amount of cars coming through with those shipments is also helpful for media and education purposes.



First Nations protesters block train to protest uranium processing plant in Toronto, 2012.

**As you're scouting the tracks, keep in mind the following questions:**

- >> How many trains roll through your blockade spot per day?
- >> At what speed are the trains traveling?
- >> Do all the trains stop in the rail yard before moving forward?
- >> How often do trains go through the yard without stopping?
- >> Do trains ever roll through the yard at high speeds without stopping?
- >> How many train lines come out of the yard? One or more?
- >> Are there mostly general manifest—explained below—trains going through the yard, or mostly intermodal?

**KNOW YOUR STUFF**

If you can get your hands on one, a *Crew Change Guide* can help you figure out where all the yards in the area are. A yard is the place where trains stop, change crew, and add or remove cars. A *Crew Change Guide* will also give you some insights about what kinds of trains will come through a yard and how often, about what security is like in the yard, and about the general layout of the yard.

Intermodal (IM) trains are trains that carry containers that get put onto tractor trailers. General manifest trains are all the other trains that carry coal, oil, grain, lumber, and other goods—also known as “junk trains.” IM trains travel much faster and are more likely to speed through yards, so having an awareness of them is important. General manifest trains tend to be slower and stop more frequently, however that doesn't mean that you don't have to be careful with them.

When tracking trains, also check out rail fan websites. Rail fans are people who are into taking pictures and video of particular trains. They track trains and get excited when new tracks are being used or new kinds of cars are coming through. They're a great resource. Search online to find the websites where they post pictures and information.

Find a good, hidden spot near the train yard and log what you see to try to find out your target train's general schedule, as well as the overall schedule of the train activity in the yard. Keep in mind that trains running newer shipments or on tracks that are poorly maintained may not have a regular schedule. Make sure to log when trains get into the yard, how long they stay and when they depart, because even if a train doesn't have

a regular arrival and departure schedule, it may always spend the same amount of time in the yard before it leaves.

Once you understand the basics, and if you're feeling a little gutsy, you can disguise yourself as a rail fan, and ask yard workers for more info. In your best normal looking outfit, go into the yard when the train is there and take pictures. Go to the yard office or talk to other workers you see. If you make it to the yard office, ask if it is always staffed so you'll know if the office will be a good place to find someone on the day of the action to alert them about the blockade. Ask about how often the train comes into the yard, when it arrives and departs, how long it stays in the yard, and what's inside it. Remember that the yard is private property, and due to safety concerns, some yard workers will immediately call the cops. Other workers may be very willing to talk with you and answer the questions of a train geek.

### **BLOCKADE LOCATION**

You want to blockade the train on a stretch of tracks where it will already be traveling slowly. Fast moving trains can take up to a mile or more to fully stop. The most likely spot a train will be going slowly is when it is departing or arriving at a facility such as a factory, mine, power plant, or port. Another option is the rail yard. Most trains slow down or even stop when going through a rail yard. However, not all trains do, so you must do good scouting beforehand.

Setting up your blockade where the tracks cross roads in the middle of cities or towns will greatly increase visibility to people in the area and can ease access for the media that want to cover the blockade. If you don't want to also block the road, just set the blockade up a little down the tracks, in sight of the road. The downside to setting up in cities and near roads is that your blockade will be more accessible to the police. Also it is ideal to set up your blockade on a straight stretch of tracks so that you are visible to the conductor from far away. Don't set up on or just after a curve.

### **PLANNING THE BLOCKADE**

As you consider what type of blockade to implement, keep safety at the forefront of your mind. For instance, if you want to use some kind of lock down, plan for people to attach only after you have confirmation from a yard worker who has the power to stop trains. It is incredibly dangerous to lock down on railroad tracks. Trains cannot stop quickly, and some trains speed through yards without stopping.

Body blockades are a relatively safer way to blockade trains because people can move quickly to get off the tracks if they need to. A body

blockade means that people are primarily putting their bodies in the way of the train's path. This could be as simple as a sit in on the tracks.

Lock downs on railroad tracks are significantly more dangerous. Think through your safety precautions seriously and plan for all scenarios. Direct support people should stay close to those locking down at all times, and they should have a clear exit strategy worked out together. Direct support people must make it clear to the police that they are essential for the safety of the people locked down. If locks with keys are being used, those locking down or their support people should have copies of the key; however, lock down equipment where the people locking down can unclip quickly will certainly be the safest. You could use lockboxes, bike locks, or chains to lock down to a stationary train in the yard, to lock to the tracks, or to lock to other people on the tracks so it is harder to move you. You could experiment with other complex blockades, like barrels, batmobiles or tripods on the tracks, but be very careful about escape plans because if a train is not stopped and runs into the blockade, you will have to get much farther away to be safe from the debris.

Communications are of essential importance in train actions. A recent oil train blockade in Maine had someone in the yard; six people spaced out down the tracks with bright orange flags and large signs that said "Blockade Ahead," "Hazard Ahead," "People on Tracks," "Stop;" a bunch of people to block the tracks with their bodies—which happened in combination with a wooden blockade structure; along with typical action roles like direct support, police liaisons, media and legal teams. That is a lot of people to communicate amongst in a dangerous situation, so be sure to have clear and direct communication.

## **SAFETY AND DEPLOYMENT OVERVIEW**

It is important to realize that trains cannot stop quickly. Coal trains, for example, can be up to one mile long and it can take more than 2 miles for them to slow to a stop if they are running at 35 mph. Trains also slide along the tracks when they brake aggressively so, really, the number one thing is to pick a location where the train will not be running full speed. It is relatively easy to get maps of train routes which will contain speed limit information. One thing to note is that trains will always have to slow down as they approach their destination so often that coal fired power plant—or something like that—is the best place to be as you know they will be going 5 mph or slower for the final approach.

- 1.** Scout ahead of time and do your research to find a deployment location that has good visibility and knowledge that the train will be going slowly.
- 2.** For deployment, it is best to have several scouts posted along the train route for as far away as 40 miles. Trains are like ships in that schedules are hard to get and not reliable when you have them. You will need to watch the track round the clock and be ready to deploy very quickly once you get word that something is coming. Another good thing about multiple observers along the route is that they can tell you if the train is slowing down or not. This is usually not hard to detect as the brakes often produce a horrible screeching sound when they are used.
- 3.** Have people in orange vests and hard hats with red flags and stop signs at least a mile up the track from the blockade to flag the train so that they will slow down. They should have radios to report back to the blockade. Ideally you will have at least a few people doing this every few hundred yards on the final approach to your blockade. It is sometimes possible to get the frequency for the engine conductor's radio and contact them directly but you should not count on being able to do that.
- 4.** No one should lock down until you know that the train has stopped. This is most important. There are many easy ways to make it seem like people are locked down but it is important that participants can get up and get away if something goes wrong like, say, the train doesn't stop or speeds up. In addition nothing should be deployed across the tracks that could get snagged or that is attached to any person or heavy thing. Really, serious about this one. Wait till it stops.
- 5.** If you are at a facility—coal plant, factory—often a train company employee will come out as the train enters the facility to switch lines and make sure that the train is heading to the right part of the facility. These people have radios and can talk to the conductor directly to tell them to stop. They should be going very slowly by this time already. Do not count on this as many facilities are now automated, but it does still happen.
- 6.** If you are blockading the train at or near a rail yard, have someone posted near the rail yard office. Their job is to notify the rail yard workers that there is a blockade in place. This person will also be responsible for communicating back to the blockaders whether or not the rail workers are actually stopping the train.
- 7.** If you are not sending someone to the rail yard to notify workers, call the train company to alert them of your blockade. Find the number of the rail yard closest to your blockade and notify them. You need to know which company owns the rails you are blockading. To find out



the name of the train company you will be dealing with, look at the engine units. The company name should be painted on the side. In many states, there are emergency numbers posted at every intersection between train tracks and roadways. They will have a number indicating what intersection they are at and a phone number to call in case of an emergency on the tracks. When calling this number you may end up talking to a call center far away; you cannot count on calling this number to result in the train being stopped. But it is still a good idea to try everything to keep everyone safe, and it can help later in court to show that you used all means possible to notify the train company.

**8.** Know the relevant laws in the jurisdiction you are in. In some places it is now a felony to interfere with energy production by, say, blockading a train. In other places it is a misdemeanor. Know which you are likely to face. It also matters whether you are on an energy facility's property or on railroad property. In some instances there will be one railroad tie that is painted and indicates the property demarcation. In other cases you will just have to research it using county GIS data, or tax records, for instance. In different jurisdictions this can have a big impact on what you are charged with and whether it is a state or federal charge.

**9.** Know where the nearest hospital is and have a car and driver ready in case you need them.



Australian climate activists block coal train after Copenhagen climate talks fail, 2009



# >>> SHIP BLOCKADES

## DIRECT ACTION ON THE HIGH SEAS

Ships, like freight trains, transport many objectionable products and materials, such as raw logs and tropical timber, oil, plastics, chemicals, and waste. Ships also dump waste, even radioactive waste, at sea and are responsible for whaling and industrial fishing. Fortunately, they are very blockable. Earth First!, Rainforest Action Network, and Greenpeace activists teamed up in 1992 and successfully blockaded and hung a huge banner off of a ship importing tropical timber at Long Beach, California. This action was very successful and drew international attention to the destruction of rainforests.

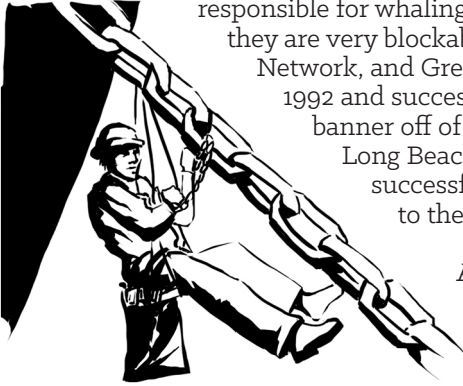

A well-coordinated ship action can take months to plan, fundraise for and may require specialized training. Like trains, ships are very dangerous and challenging to communicate

with. Ship blockaders must be extremely cautious. Not only could anyone in your group sustain the typical land based injuries, they could also drown. Because of this, Personal Floatation Devices (PFD's) should be worn by everyone.

Automatic Identification Numbers—AIS—are given to all international ships and most large domestic ships. This number is used in a digital tracking system that aids in vessel navigation. You can search online for current information about particular ships and ports.

Marinetracker.com and vesselfinder.com both offer these services. Having radio communication with a ship that you are blockading is essential for clear communication. Be familiar with the Emergency Broadcast Frequency for the area you'll be working in. Use this channel to alert a ship to a lock down when your team is in place, then ask to switch to an alternate, clear channel for further communication.

Blockading ships often involves using ships. In 1989, Sea Shepherd Conservation Society crew members very bravely and defiantly deployed rigid hulled inflatable boats—RIB—from the Sea Shepherd vessel in order to lock themselves to the anchor chain of the Venezuelan tuna seiner Pan Pacific in Costa Rica's Puntarenas harbor. This action helped Sea Shepherd later leverage an agreement with the captain of the seiner to hand over the coordinates of the operating Mexican and Latin American tuna fleets in the Eastern Tropical Pacific tuna grounds. Sea Shepherd then moved there to harass and chase the tuna boats from the area, successfully preventing the boats from setting their nets on dolphins.

A flotilla of small crafts can also hold a monster ship at bay for some time until the coast guard clears them away. Australian activists have blockaded tropical timber import ships for hours with nothing more than their kayaks.

Winnemem Wintu Tribe members joined with members of other tribes and environmental activists in multi-colored kayaks and rafts to place a banner over the McCloud River on Lake Shasta proclaiming “River Closed”.

For more lasting blockades, climbers can board the ship from zodiacs and lock down to the ship or hang a banner off the side of it. The masts, cranes, and towers of the ship are also good targets for banners. Be prepared to get soaked by fire hoses from the ship you are trying to board. Many folks choose to wear rain gear, a helmet, and goggles. The boat driver may choose to wear a helmet with a clear face shield to keep water out of their face.

To board the ship, bring a caving style rope ladder with an industrial locking snap hook attached to the top. Use a long pole to clip the snap hook around a railing on this ship. If you do decide to use watercraft in your action and it is in the US, be prepared to have that watercraft confiscated by police.

A multitude of U-lock and lockbox opportunities exist on a ship from the railing, to the paint and eye hooks, the rudderstock, even the anchor itself can be locked to. Large camming devices that rock climbers use to wedge into crevices can be used to lock into drain or discharge pipes on the side of the ship as well, offering a convenient and secure place to clip your lock down jewelry. It is important to stuff tight fitting tupperware containers into these drains before you lock into them though, to prevent the ship’s crew from discharging water or waste onto you.

Depending on what you’re trying to blockade, you may not need a boat. In 2012 activists with Radical Action for Mountain People’s Survival –RAMPS–and Mountain Justice snuck onto a coal barge and locked themselves to it. As this was happening, another crew of folks was blockading road access to a nearby mountain top removal site. Double whammy!

Ships have also been blockaded coming in or out of port by climbers rappelling off a bridge with a large banner that serves to deny access to the offending ship. Keep in mind you may be blocking other boat traffic inadvertently.

Ports are under jurisdiction of the Department of Homeland Security and actions against ships carry the potential for heavy legal repercussions. Blocking a navigable waterway is a crime in and of itself, and you may very well face other serious charges for ship related actions. Research the laws before engaging in ship blockading so you know what you are getting yourself into.

# >>> HELICOPTER BLOCKADES

Helicopters are used to build dams, spray toxic chemicals, harass civilians, transport military arms shipments, log the forest, and of course are used by law enforcement. Much of Earth First!ers' experiences have been with helicopter logging. Helicopter logging is promoted as an environmental solution to the impacts of industrial forestry. It's said to reduce erosion and prevent road building, but the truth is that helicopter logging is a hoax. Anyone who has experienced firsthand the ear splitting roar of logging helicopter engines, the noxious diesel pollution they spew into the pristine forest canopy, the furious pace at which they extract trees, and the violent thrashing of the canopy that the wind from the blades causes, knows that helicopter logging is extremely destructive.



Logging helicopters can be blockaded in several ways—see **Aerial Blockade**. A first step is to prevent helicopters from ever taking off by locking down to them with U-locks and lockboxes while they're on the ground. Once the copters are up and flying, other tactics must be employed. People running around in the logging area, cat and mouse style, can delay operations until cops and workers clear them out or arrest them—see **Cat and Mouse**. However, for a group intent on stopping helicopters, the focus should be the landing pad. Without access to a place to land, helicopters are unable to operate in an area. Please see **Lock Downs, Tripods, Bipods, Monopods, and Platforms** for more info. Plain old treesitting works too. Canadian forest activists successfully repelled helicopters with treesitting on Vancouver Island.

A variation of a treesit is to have the sitters occupy the trees adjacent to the landing pad and run intersecting traverse lines above and across the landing pad to prevent the copters from landing. If focusing on a particular section to be logged, an aerial platform with lots of support

lines tying trees together, broadens the defended area. Although these blockade ideas are elaborate, the Syracuse Women's Affinity Group blockaded the airstrip of the Seneca Army Depot in New York in 1983 by simply sitting down on the airstrip with their arms joined together.

Furthermore, pilots will steer completely clear of anything that the strong winds created by the copter blades could potentially suck up into them. With this knowledge, treesitters have deterred helicopters by suspending weather balloons and flags from the forest canopy. Along with ground support people, sitters have also heavily and widely dispersed 6' square pieces of brightly colored linoleum on the landing pad and in the trees. A good way to extend the effectiveness of the linoleum is to brightly color two-thirds of all the pieces and camouflage the other one-third of the pieces. This way, they can never be sure that they picked up all the pieces, and letting the copters in would simply be unsafe. All of these objects have kept helicopters out of the forest.

Also consider that helicopters are on the ground without people in them more than they are in the air. The rotor blades, air speed indicators, and cargo hooks of helicopters are extremely sensitive. The pilots are acutely aware of this and thoroughly check the helicopters before flying. Aside from the landing pad being ripped up, the thing that pilots, corporations, and law enforcement hate second most is when people scatter objects and debris in the areas where the helicopters operate. Most important is to be absolutely sure to anonymously announce to the media, helicopter corporation, and law enforcement exactly where this act has been done with plenty of time before anyone would encounter it. Throwing something at a moving helicopter is extremely dangerous and deadly.

Helicopters cost \$250-\$2,000 a flight hour. Any disruption of their scheduled work time is going to cost the responsible corporations lots of money. Furthermore, spare part replacements could take days, or even longer to complete.

# >>> BANNER HANGS

When it comes to massive banner drops that are effectively deployed and eye catching, Greenpeace really takes the cake. Below is a series of images borrowed from their training manual. While their climbing techniques differ from those described in this book (mainly using a two rope industrial access technique), the images are a great reference and offer some ideas to help deploy your own jaw-dropping media hijack operation.

Three distinct styles are shown. Notice the combination of slings, carabiners and prusik hitches to secure the banner edges and hold tension on the banner. Doing dry runs of banner hangs on this scale can be a bit challenging, but try to look for bridges that have minimal traffic or an abandoned building with a side that is hidden from street traffic or other buildings.

Take into consideration how wind will effect your banner and cut out slits throughout, if necessary, to avoid ballooning or whiplashing and shock-loading your climbers.

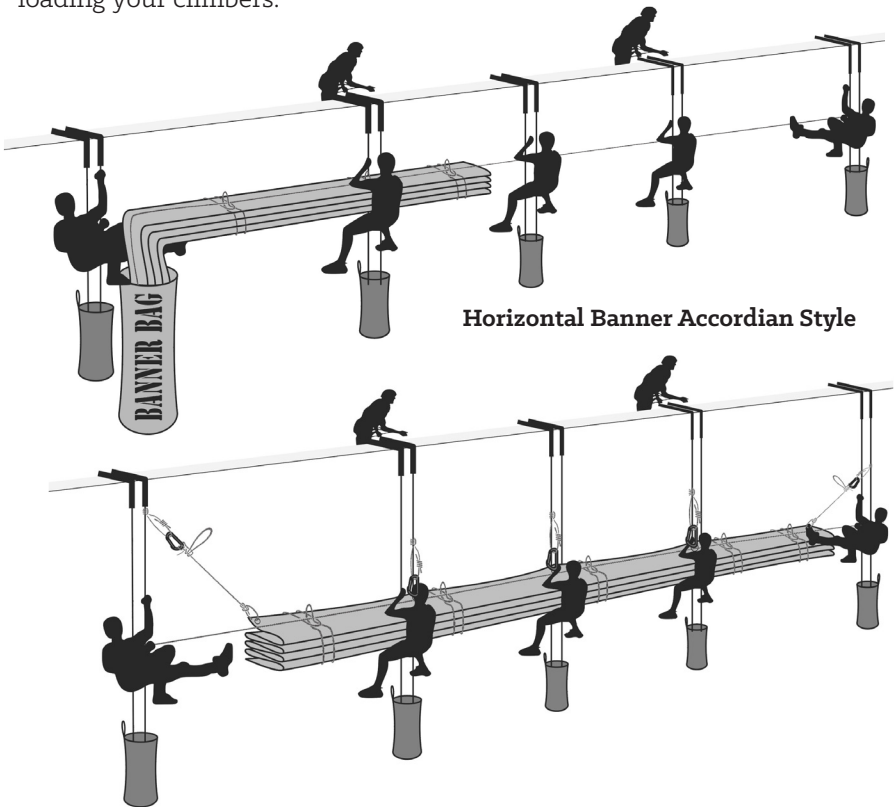

## Horizontal Banner Rolled Style



**Don't forget to check  
the spelling and  
grammar on your  
banner!**

Vertical Banner Stuffed Style

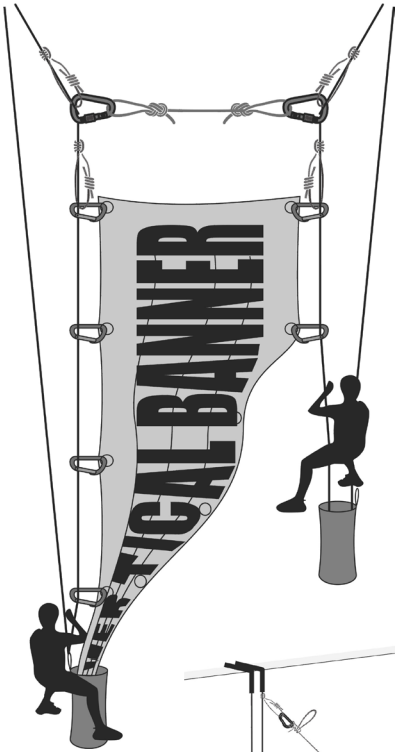



# >>> BILLBOARD OCCUPATION AND ALTERATION

## OCCUPATIONS

- + Not easily accessible to police
- + Highly visible
- + Relatively easy access
- Requires specialized climb training and gear
- Danger of falling from extreme heights

*Do not attempt billboard occupations if you have not successfully completed a climb training from qualified climb trainers.*

Billboards are an often overlooked venue for doing banner drops. They have a lot going for them. They are generally easy to access and have no security, unlike office buildings. They tend to be located in places where lots of people will see them. Many are high enough off the ground that the cops will need to bring out special equipment, and you can hang banners without having to rappel. Also you don't have to stick around and get arrested if that doesn't seem strategic. A banner left on a billboard could easily stay up for hours or days depending on if and when the billboard company becomes aware of it.

## PREPARE THE BANNER

The most common size for billboards is 14'x48'. You'll want to have a banner that takes up most of that space so that it can be read from far away. It can be hard to get enough fabric for a banner that size, so do what you can. Retired banners are sometimes available from advertising agencies, however, they are heavy. A 10'x30' banner will be plenty big. Make your message short, to the point and easy to read. Put grommets in the corners of the banner as well as halfway between each corner, as this will give you something to attach rope to when anchoring the banner. You can either buy grommets from a craft store or you can make your own duct tape grommets. Place several layers of duct tape on each side of each corner to reinforce it. Poke holes through the duct tape and fabric with a knife. Tie 10-15' of cord to each grommet. These will be what you tie the banner to the billboard with. Make sure the cord is strong enough to hold the banner in heavy winds. Do this before climbing the billboard, as it will save you time once you are up there.

## GETTING ONTO THE BILLBOARD

First you need to figure out how to get up the billboard. There are tons of different styles of billboards. The most common billboards found along interstates have one central column that are from 20'-70' tall. Generally, they have a ladder running up the column that stops 8'-10' from the ground. You simply need to bring the right size ladder along to access it. Scout ahead of time to figure this out. And remember, the taller the billboard, the more difficult it will be to get you down. You may not want to bother with the shorter ones.

It's recommended to have two people climb the billboard in order to ensure smooth banner deployment. If you are using a ladder to access the billboard, you will likely be driving it to the scene. Have the driver or another person hold the ladder while you and your buddy climb up to the ladder on the billboard. Once you are off your ladder, it and the car you came in should split—you certainly don't want the cops using your ladder to evict you or impound your vehicle.

Climbers should be wearing harnesses and have two 3-4' lengths of webbing, each with a carabiner. Clip one carabiner to the ladder rung while you move the other to the highest wrung you can reach, so that as you climb you are always clipped in to the ladder. This will make your climb slower but it's essential for safety. Once at the top, you will find that the billboard company has conveniently provided a platform running along the front of the billboard which you can work from. Always remain clipped to the platform while you work. Many billboards will have a ladder up the back of the actual billboard, so that you can easily climb to the top of the image you will be covering up. If there is not a ladder, you will have to figure out a way to safely climb to the top, or you may choose to hang the top of the banner from the platform that runs along the bottom of the billboard. If you are going to hang the banner from the

### 5 HELPFUL STEPS FOR A CRAPPY BANNER DROP

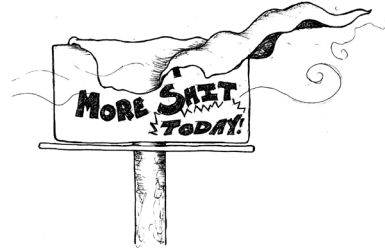

DO A BAD JOB TYING IT DOWN!



WHATEVER YOU DO,  
DONT MEASURE ANYTHING BEFOREHAND!!



MAKE YOUR BANNER COMPLETELY ILLEGIBLE!



BE UNSAFE!



BEST OF ALL,  
DONT EVEN DO ANYTHING!!!

platform you will need to bring weights to anchor the bottom. You will also want to cut slits in the banner to reduce air drag. Again, when you scout properly you will know ahead of time where you can attach your banner.

### **ON TOP**

Tie the corners of the banner to the top and bottom of the billboard. Depending on how windy it is you may want to tie it down in several other places. Make sure that it is stretched tightly in all directions so that it reads well. The taught line hitch can be a handy way to adjust tension on your banner.

Once the banner is secure, why not use your time wisely and start making some calls to the press? That way, you can let them know what you are doing and why you are doing it. Hopefully they will show up and help spread your message even further. Be prepared to be up there for a while: don't forget rain gear, water, food, and maybe even a shit bucket. It's a good idea to have a ground support crew at the base of the billboard to interact with police, workers and media.

### **REMOVAL**

If you're lucky the police may not even show up (although that's unlikely). They may try to pluck you off with a cherry picker or a fire department ladder truck. Police may climb up the ladder and try to force/coerce you down. But it isn't easy forcing someone to climb back down a ladder. They might also climb up and cut down your banner, and wait for you at the bottom while you feel stupid for being on a billboard without your banner.

## **ALTERATIONS**

- + **Inexpensive**
- + **Only need a few people**
- + **Creative way to get your message out**
- **Potential for more severe charges than civil disobedience**
- **Danger of falling**

You don't have to wait around and get popped to get your message out on billboards. There is a world of possibilities by which you can alter these foul mouthpieces of corporate America. The simplest approach is just straight up defacing the billboard with paint bombs.



Billboard companies have been known to drop certain advertisements after repeated attacks from nocturnal activists.

For those with more refined tastes, subtle alterations of the existing billboards with spray paint or wheat pasted words and images can be used to subvert the advertiser's agenda. Sometimes its just a matter of blacking out one word in a message to change its meaning completely. Get creative.

### **SIZING IT UP**

Spray painting is pretty straightforward. Wheat pasting text or images takes a little more time for preparation and deployment. First you need to figure out how big your text is going to be. Depending on how high up the billboard is, this can be tricky. If you are trying to mimic the lettering on the billboard you will need to get more accurate measurements. If not, you just need to make sure your words are legible from a distance. The most accurate measurements will be obtained by climbing the billboard ahead of time and actually measuring the letters. This exposes you to risk ahead of your action, but will give you the best data.

Another option is to take a picture of the billboard from straight ahead and print it out. For this to work you will need to know the actual dimensions of the billboard. The most common billboard size is 14'x48'. Using a ruler draw a grid with 14 evenly spaced horizontal columns and 48 evenly spaced vertical columns. Each square represents a square foot. So if a letter takes up one and a half vertical squares, it is about 1.5'. Don't forget to delete the pictures and burn that printout when you are done. The only other part of this is figuring out which font they are using. Unless you've got a graphic design buddy with a keen eye, you're just going to have to compare the billboard image with the fonts you have on hand.

### **PRINTING IT OUT**

Many copy shops have large format printers where you can have your words printed out. If you need to get really big, you may have to print each letter individually and piece them together yourself. You should go to another city to do this and pay in cash to avoid leaving any trails. If you want a little more privacy you can also use the self serve copiers and print letters out individually on 8.5x11" or 11x17" paper. Letters that are 1' tall should be visible up to 400' away.

### **PASTING IT UP**

First mix up a batch of wheatpaste. Take 1 part white wheat flour and mix it with 4 parts water. Whisk thoroughly to get lumps out while bringing the mixture to a boil. Cook on low heat until it reaches a thick,

glue like consistency. If you want, you can mix in some Elmer's glue or wood glue to the mixture to beef it up. A half cup to a cup of glue per quart of wheatpaste should do the trick. Use the wheatpaste within 12 hours of making it. You can also just buy wallpaper paste from the hardware store if you aren't feeling like mixing up a batch of wheatpaste and use that instead.

Choose a time of night where there will be minimal traffic past your billboard. You should have at least one lookout to keep an eye out for cops and people who might call them. Put the wheatpaste in a paint can or bucket. Another option is to put it in a water bottle with a squirt top, so you can just spray it out. Apply the wheatpaste to the billboard surface and spread with a paintbrush. Stick your posters to the wheatpasted area and smooth over it with your hands or a squeegee so that it sticks well. Get those corners especially. Apply another coat of wheatpaste on top of your posters with a paintbrush. One person applying wheatpaste while another slaps the posters on makes for easier work. Now get the fuck out of there in a calm and unsuspecting manner.



Activists with Portland Rising Tide occupy a billboard to stop construction of a coal export facility

# >>> TIN FOIL HATS

- + Eases the mind
- + Cheap
- + Easy to construct
- None

The black helicopters are hovering overhead, every conversation and thought you have is recorded and stored in that damn NSA supercomputer in the desert, each stranger who is nice to you is probably really a top secret FBI agent trying to develop a psychological profile on you, you're pretty sure a drone tailed you on your way to the supermarket yesterday, and maybe, just maybe, your dog is actually outfitted with a sophisticated surveillance implant in order to keep tabs on your eating and bathing habits. And what about chemtrails, lizard people, the secret Freemason tunnels, and come to think of it, who really killed JFK anyway?

Do not despair. There is still one last line of defense against the soul crushing, ulcer inducing, maybe you just wet your pants, Total Surveillance State (TSS). The tin foil hat. After decades of development and refinement in basements, bunkers, and dish pits; and having undergone intense field trials, there is finally general consensus—based on chatter from internet forums, classified ads in the back of Soldier of Fortune magazine, and general hearsay—amongst the many brave field technicians on the proper way to construct a tin foil hat.

## MATERIALS NEEDED

- Tin Foil

Contrary to popular belief a cooking pot, metal bowl—or god forbid—a strainer—all those holes!—worn upon the head will not protect you from the TSS. You must use tin foil!

## CONSTRUCTION

Get yourself three sheets of tinfoil each about three feet long. If you have a particularly large head, you may need to purchase a restaurant sized roll of tinfoil rather than the standard 12" to account for the extra girth. Take each sheet and crumple it into a ball. Do each one separately otherwise you will have one hell of a time getting them apart from each other. Now uncrumple each sheet back to its original shape. This step

is essential because it creates thousands of micro-crinkles. The micro-crinkles are really what intercepts and diffuses the incoming radiowaves before they get to your brain. They also scramble any potential outgoing broadcasts from implants that may have been placed in your body by semi-autonomous insect drones without your knowledge.

Most people say that two layers are enough, but three can't hurt—plus the third layer adds a little structural integrity. So, lay the three sheets on top of each other and roll them into a tube approximately the circumference of your head. It is important that the bottom edge of the tin foil hat gets good contact with your skin. You're probably going to need to do a little grooming. The bowl cut is pretty popular—you can use that metal bowl now—or you can pull your hair up in a bun and shave a line around your head, whatever floats your boat.

Place the tinfoil tube over your head so that it rests firmly just above your eyebrows—gotta cover that third eye. You're going to want at least a foot and a half of your tinfoil tube sticking out above the top of your head. Tighten the tinfoil around your head by smushing it together. Ok, this is the critical part: with one hand grab the top of the tinfoil tube while the other hand cinches the tube where it meets the top of your head. Now twist the top of the tinfoil tube counter-clockwise until it resembles your average unicorn horn.

Creating what looks like a giant metal antennae on your head might seem counter-intuitive when it comes to blocking the electronic signals of the TSS. Again, it's all in the micro-crinkles. The tin horn actually works to intercept the signals before they find another way in ears, nose and then the micro-crinkles once again come to the rescue by diffusing the electromagnetic waves before they infiltrate your brain.

Tin foil hats are generally thought to work best when you are alone, preferably for weeks on end, holed up in a basement, isolated cabin, or abandoned missile silo. Some do feel comfortable wearing them in public and there is actually a growing movement to bring the tin foil hat out of the shadows and into mainstream society though debates on this subject remain heated and often divisive.







# DOUBLE DARE YOU

*Mi'kmaq warriors build a burning barricade to prevent police and fracking equipment from entering their lands in New Brunswick, 2013*

# >>> A PAPERWRENCHERS TOOLBOX

Considering that nothing causes our enemies more terror than losing money, paperwrenching—a play on the term *monkeywrenching* which encompasses the art of filing various forms of legal challenges to obstruct construction or extraction—can be a developer’s worst nightmare. Without question, paperwrenching has cost corporations and governmental agencies losses comparable to road blockades and sabotage, and likely much greater setbacks and failures. Often when our campaigns and struggles are victorious, it is due in large part to legal challenges being filed in tandem with protest pressure and direct intervention.



While the ways of the paperwrencher could be a book all its own—or perhaps the course work of a full law degree, there are some basic things to know which can help anyone get started. First, you don’t need to be a lawyer to bring your case to a judge. Just as activists often defend themselves in criminal court, plaintiffs can represent themselves quite easily in most of the administrative proceedings that are part of the process for granting permits to miners, loggers and developers of all

stripes. In *legalese*—the formal and technical language of legal documents—this approach of self-representation is called *pro se*. There are public resources available, such as law libraries, which can aid in your research, though at some point, having friendly lawyers to consult with is invaluable.

Permitting processes can vary significantly from state to state, but the US federal requirements and regulations are often interlaced. Obviously, the story changes in other countries. Knowing the applicable state statutes which explain the permitting process in the state where you live is not as complicated as it sounds. In fact, if you can get your hands on the permit you're challenging, it often offers a road map to work off, usually listing the code numbers of many specific laws you'll need to reference in order to establish standing and look like you know what the hell you're talking about.

Remember, you are entering a battle field in which you are trying to use the opponent's weapons against them. With enough grunt work and attention to details, this can result in victories, but it can also lead you down the path of many shady compromises. Regulatory agencies were set up to deflect public wrath from corporate perpetrators and act as shields between communities and profiteers. A first response will often be to offer payoffs or piddly concessions. This is your chance to make "No Deal, Assholes" more than a sticker slogan.

What follows is a paperwrenching glossary of useful terms, acronyms, agencies, and legalese, broken into three categories: laws, agencies, other relevant miscellaneous stuff. The following definitions will demystify the bureaucracy, and hopefully get you started in the potentially soul-crushing but awesomely effective path of the paper warrior.

## SOME LAWS TO BE FAMILIAR WITH

### **NEPA—The National Environmental Policy Act**

This will be the primary tool—or arsenal of tools—that has a chance of slowing or stopping a nasty permit from approval or renewal. It's been around since 1969, but you wouldn't know it by looking at all the industrial shitholes surrounding us, eh? If there are federally listed species, if there are navigable waterways in the area, if there are state border crossings, these are things that may trigger NEPA, on top of whatever crappy state permitting laws exist.

### **CWA—Clean Water Act**

Like NEPA, this is a strong law to reference in relation to water pollution. Through CWA, you get to deal with the NPDES (National Pollution

Discharge Elimination System) which is the mechanism of the CWA for permitting discharges of pollution. Sadly, the Clean Air Act, though it sounds like a similar law, has been less successful as a tool to regulate pollution.

### **ESA—The Endangered Species Act**

Documenting harm to these plants and animals, and their habitat, will often be a big part of successful paperwrenching. (See also FWS below.)

### **NEPA's Environmental Justice Act**

Back in the 1990's, this was added to NEPA by President Clinton's Executive Order #12898. Some of the language is redundant with the Civil Rights Act of 1964 which also addresses environmental racism. But the EJ Act requires impacts to communities marginalized by race and/or class to be thoroughly reviewed via demographic studies and extensive research be presented in an Environmental Impact Statement–EIS. This is where ground-truthing and community organizing collide, so take those stupid misanthropic bumper stickers off your water bottles and go meet your neighbors!

### **NFMA—National Forest Management Act**

This is important for forest defenders on public land. Surveys within this arena have succeeded in delaying, scaling back and outright stopping timber sales, roads, and other projects on National Forest land. If you are monitoring a National Forest project, also check out the Forest Plan Handbook. This is where the vast majority of EF!-related paperwrenching experience comes from. Groups like NEST (Northwest Ecosystem Survey Team) and Blue Mountain Biodiversity Project have been at it for many years in Oregon and are generally open to training others in the ways of the origami eco-saboteur.

## **SOME AGENCIES YOU MIGHT HAVE TO TANGLE WITH**

### **Army Corps of Engineers, or “The Corps”**

The corps is one of the main entities for overseeing permit applications for projects that could impact waterways. This process entails gathering comments from the various agencies and then mindlessly rubber stamping them. A perk is that they generally have a high turnover and are not particularly competent.

### **DBPR—The Department of Business and Professional Regulation**

This agency is one state's example of an entity charged with licensing and regulating businesses and professionals. This is a less common, but effective spot to aim your wrench of paper. Did you catch one of your

opponents in an egregious and blatant lie? Complaints filed here can result in annoying and costly administrative hearings to expose, embarrass and inconvenience people.

### **DOT—Department of Transportation**

The DOT oversees projects related to federal highways, railroads, air traffic, and shipping. Most states have their own state DOT which is responsible for building and maintaining roads and is often the agency we find ourselves wrangling with when fighting a new road.

### **EPA—Environmental Protection Agency**

While this entity is often in the limelight, they only set policy; they don't grant permits. They don't tend to be directly in the paperwrencher's path, but their policies are worth having some basic understanding of in order to effectively argue your position.

### **FWS—Fish and Wildlife Service**

This is the agency that conducts—or fails to conduct—much of the relevant permit review regarding impacts to wildlife. FWS may hand off oversight to an even less competent, more easily corrupted state agency. The FWS is also who you would go through if you were to undertake a petition to grant a species protection under the ESA—a worthy endeavor, but a whole other beast from the elementary level paperwrenching.

### **USFS—US Forest Service**

#### **BLM—Bureau of Land Management**

These two agencies are the largest public land owners in the country. As such, they oversee massive logging, mining, grazing, and road building operations, all subject to various regulations by assorted agencies. Anyone can request being added to the NEPA “scoping lists” to get notified of threats to these lands. Contact supervisors' offices and ranger districts in your area to find out how to go about getting on these lists.

### **USGS—US Geological Survey**

These folks also don't tend to enter the permitting process directly, but they produce some useful maps for delineations of wetlands and other features of ecosystems that may be relevant to your paperwrenching research.

### **DEP, DEQ, DCA, RPC, WMD...**

These are various acronyms for state agencies across the US who will likely be approving permits for our enemies to move forward with their nefarious deeds against land and water. State statutes generally outline the permitting process they are required to follow. Within that you will find step-by-step language explaining how you get your foot, er wrench, in the door. For example, you will likely come across statements like this: “The Department

is under the executive branch of the Governor and is governed by Chapter 120, F.S. The Department is structured according to the requirements of Section 20.165, F.S.” In this case, it is a Florida Statute (FS). You should be able to simply type the Chapter and Sections into a search engine and find ‘em online.

## RELEVANT MISCELLANEOUS STUFF

### **Administrative Petitions**

Yes, we know you cringe at the “P” word, but this is a bit different. One person can file an administrative petition mailed in on a scrap of paper and delay a development for months by simply triggering the scheduling of a formal hearing in front of an Administrative Law Judge. Often, a simple intervention causes the agency’s legal division to send you a packet explaining where to go from there. Likely, your petition will be “Dismissed Without Prejudice,” meaning you are able to refile it with corrections to all the mistakes the agency must point out. This process also entails having to prepare discovery, present witnesses and prepare cross-examination of your opponent’s witnesses. It’s not as complicated as it sounds. If you’ve been in an action affinity group of any sort, you could handle this stuff too.

### **ALJ—Administrative Law Judge**

An ALJ is an official who presides at an administrative trial-type hearing to resolve a dispute between a government agency and someone affected by a decision of that agency. They can be recused, meaning you can make a motion to have them removed from the case for conflict of interest if, for example, they have close affiliations with an industry interest under scrutiny. It’s generally a long shot, but worth the effort, as it could result in buying additional time and costing opponents additional money and social capital—and catching a corporation buying off judges is a nice juicy story that could likely gum things up for awhile.

### **BO—Biological Opinion**

This document, generally produced by FWS, is an entryway into challenging wildlife impacts in the absence of an EIS or EA. Tearing this document apart is a big step to getting greater scrutiny over a permit.

### **BMP—Best Management Practices**

Under the aforementioned laws, corporations are supposed to be required to not totally trash the place up. For a project that is already up and running and found to be avoiding BMP’s, this may be a costly permit violation.

### **Cumulative Impacts**

This aspect of NEPA reviews is one of the most powerful legal tools on the books. Basically, it is supposed to require an overall view of the impact of



a project in its totality and in relation to other existing or pending impacts. Some state agencies may have similar criteria.

### **CVs**

A Latin acronym for *curriculum vitae*. This is the document that expert witnesses present to a judge to prove their qualifications. Take the time to read over your opponents CVs. You might find something misleading or inaccurate that may be of interest to the Department of Business and Professional Regulation (DBPR), or other similar bodies.

### **EA—Environmental Assessment**

This is the level of review below an EIS. It is significantly weaker and scumbag corporations frequently come up with excuses to go this easier route. For example, a pipeline will often get permitted in segments, conducting an initial EIS when no one is paying much attention. The future segments can then allege that an EA is all they need, avoiding the harsher scrutiny.

### **EIS—Environmental Impact Statement**

This is the highest level of review for projects which trigger federal oversight under NEPA. Slime ball corporations are always attempting to find ways around it. Proving it is required is often the first step of bringing a development or extraction project to its knees.

### **Expert Witnesses**

These are the people that will really be arguing the issues. The most that laypeople can offer in these situations is to gain the legal standing to have the case in front of a judge. An Administrative Law Judge looking at a permit challenge is only supposed to look at the facts presented by qualified experts. This is an arena where one can really see the collusion of state and industry, as all their experts line up to testify against you and your rag tag posse. This is where it comes in handy to not alienate your friends and allies with real jobs and college educations. Think: hydrologists, biologists, chemists, geologists.

### **Field Checking or “Ground-truthing”**

This is generally the most exciting part, where you get to hike around in an area and look for threatened or endangered species, critical habitat, wetland delineations, impacts to human health in marginalized communities—all the stuff that might end up as evidence later. One of the reasons paperwrenching is included in this collection of direct action skills and tactics is because sometimes you may have to trespass and sneak around in places that other environmentalists are afraid of going! Take good clear pictures and GPS points. If on private land, consider playing the role of the oblivious bird-watching nerd—you know the type. Bring a notebook to

indicate the GPS points and the picture that it corresponds to, and be sure to document anything you'll want to remember. For example, if you took a picture of a gopher tortoise burrow, are there any signs of habitation that aren't visible to the camera?

### **Motion for a Stay of Permit**

This serves a similar purpose as an injunction. In the cases where we are aiming to keep the bulldozers at bay, this is a key phrase which must be used at the right time in order to be effective. For example, if one is contesting a government agency and feels very confident that they will be shot down, but are continuing for the sake of preserving the record to file an appeal, you must make your motion to stay the permit at hand before the case is closed. If you do not, an appeal court not hear this matter, as it would be considered new evidence not in the realm of appellate procedure. I know that sounds boring as fuck, but just listen. The endangered critters will be ever so thankful when they are spared from being entombed in their burrows.

### **NOI—Notice of Intent**

Paperwrenching is a race, sometimes an ultra marathon, and for many types of permits the NOI is the starting line. This is where the agency overseeing the permit has to declare its intention to approve a permit and give the public a chance to make comments and/or intervene. These are often required to be published in a regional newspaper of the affected area, but notification can also be requested from the agencies. The window of time to respond is generally a few weeks; NOIs will typically specify something like 14 or 21 days. This can be a good first place to start tripping 'em up. Was the notice filed properly? These people don't tend to expect opposition and often get sloppy. Did they miss any components of the required notification? Calling them on it can set them back for weeks or months.

### **Standing**

Failing to establish standing is a very common way to have a good, fun paperwrenching endeavor go sour before reaching its full potential. Standing means you must be able to make the case that you have a reasonable belief that you, or someone in a group you represent, will experience hardships caused by the project in question, but it can get a bit tricky, as you can only represent yourself pro se—which also means you can file as indigent and waive the cost of filing fees which are expected in certain legal arenas. While groups generally have an easier time establishing standing, they can require an attorney to file on their behalf.

Think of paperwrenching as intervening in a big strategic chess game—but you're not a pawn. You're a knight, bishop, castle or queen—and the king is vulnerable. Keep your principles and long term goals clearly in view. And don't forget to try and have some fun along the way.

# >>> MAKING LIFE HELL

- + Easy to plan and have fun
- + Can quickly influence someone to change their position or policy
- Sometimes hard to keep a positive image in the media
- Charges for going to someone's home can be harsher

The destruction of the earth does not end when CEOs and other corporate hacks leave the office—and our efforts against them don't need to stop either. It's important to explore every protest opportunity to make sure that those with the power to give you what you want don't forget about you. Block them from getting to their office, disrupt business as usual, get rowdy as all hell, and when they go home...go there too! Day or night, the message gets sent loud and clear—we know where you live, and we are not stopping. No need to send those threatening letters that carry some pretty scary penalties—they'll get the hint when you show up at home.

So who might be deserving of all of this fun? Lots of people. Do strategy exercises for your campaign to help decide your targets: find points of intervention to think about where to look for targets, power mapping so you know who can give you what you want, a tactics star to decide what type of action to plan and what the tone should be. Targets can include the company's executive board, a politician or two, a judge or particular cop, an influential jerk in the area....

## OFFICE DEMOS

The office is typically where the decision makers get together to do their dirty work. They like their closed doors staying closed, and are not particularly appreciative of people who show up unannounced to interrupt them.

### SIMPLE PROTEST

Having people running amok, or even just being there all together chanting is sure to stop work for a while. Be as traditional or non-traditional as you want. Bring signs and banners, chants and whistles; or get a little creative with it. The point is just to hold the space in their office for a while and make sure they aren't able to continue their work. Activists with Rising Tide visited the office of greenwashing extraordinaire, Environmental Defense, to protest the organization's key role in promoting carbon trading. While in the office, people split up. Some went to gather all the workers for an "emergency meeting" in the

board room, others put up “global warming crime scene” tape, and others rearranged the furniture and sprayed “green wash” cleaning solution over everything. Work was disrupted for at least an hour before the activists took it outside and had a protest in front of the building to help raise awareness.

### **GET SOME GOODS**

While the protest is happening, especially if it's a little chaotic, it could be a good time to deal with some paperwork. Have a couple folks whose role it is to grab binders and files and make a mad dash for the door. Many a campaign has gotten the inside scoop after going inside and scooping it.

### **MAKE A DELIVERY**

Take advantage of the uncontrollable atmosphere of the demonstration to deliver the jerks a taste of their own medicine—just remember to obscure your identity from the cameras. Earth First!ers have pelted Taco Bell with rotten tomatoes in solidarity with the Coalition of Immokalee Workers, dumped buckets of messy coal at Bank of America branches to urge divestment from mountain top removal and made a host of other stinky, messy deliveries.

An action after an Earth First Rendezvous in Maine saw a double delivery during its demonstration against the proposal to build a liquid natural gas pipeline off the coast that threatened the health of the coastal ecosystem including precious lobster habitat. While one affinity group assembled and ascended a tripod on the front lawn of the Governor's mansion to secure the occupation of space for the demonstration, separate affinity groups delivered hundreds of pounds of foul smelling, rotting lobster guts and created a black, sticky “oil slick and slide” on the front lawn. Friends say that the smell stuck around for weeks.

### **OFFSITE**

You don't have to personally show up in the office to make an impact either. Have a phone-in day where you publish the direct numbers of particular workers, or just the office number, and get as many people as possible to call and read your statement. One way that people have gotten lots of calls has been setting up a table outside stores on the day



of—pet stores for animal rights causes, camping stores for eco-defense, etc.—with a cell phone for folks to use. If you can get your hands on a fax machine you can send them a fax of a couple pieces of black paper taped together into a loop. Their toner will run out and they won't be able to receive their business related faxes anymore. Get the email addresses of key personnel—typically companies have the same formula for all internal emails so if you get one for a lackey it might work for the higher-ups, i.e. lastname.firstname@company, or firstletter\_lastname@company. Flood their inboxes with letters; sign them up for listservs—the more wing-nut, the better.

## HOME DEMOS

Neighborhoods are great places for organizing work. Whether it's a block party, doing door to door canvassing, a new “mural” project, or just a good ole fashioned front yard bbq at the chief of police's house. Going to your enemies house can be great fun. Oh, and they really don't appreciate it.

When planning to visit someone at home, it's important to do your research first. Once you find the right house belonging to that special someone, it's time to get buck wild! Below are some simple ideas that are easy to expand on. If you need some inspiration check out the anti-vivisection campaign SHAC (Stop Huntingdon Animal Cruelty); they pushed the idea of the home demo to a whole new level.

### SIMPLE PROTEST

Show up with some signs, know where their property line is, and start toeing it as you march back and forth chanting and yelling and carrying on. Bring drums, bullhorns, or other noise makers—though be sure to check out city noise ordinances to understand the legal risk. Make fliers to deliver to the neighbors, post on parked cars, or hand out to other passersby. While protesting conditions at the local jail, activists in Michigan visited the Sheriff's house early one morning with signs and fliers—later that same day the first of their demands was met.

### DIRECT COMMUNICATION

Adding to the simple protest, have a contingent go knock on the door. The conversation can look like whatever you all decide is strategically best—from trying to reason, share stories, get a little loud, or leaving some dog poop.

## LASTING MESSAGES

If no one is home, or if they happen to be asleep, you can always leave a message behind. Being conscious of potential charges will help decide what medium the message should be written with chalk on the road/driveway/front porch/front door, signs and banners staked around the yard, banners in the trees, spray paint or etching solution on windows.

## OTHER ANTICS

The possibilities are really endless, and you should let your imagination run wild. Does this person go home and try and wash the blood off their hands? If you turn off their water with a curb key and cement it shut, they certainly won't be able to do that anymore. Do they only value money and property? Some slashed tires, paint stripper, and sand in the gas tank can certainly make them think twice about if their choices are worth it. Thanks to the good ole internet it's easy to post people's contact info for fake events and free items, or to order deliveries that need to be paid for. Channel your inner younger sibling energy and you'll be sure to make someone's life hell.

## WHERE ELSE?

There's no need to limit yourself to just these two spheres of life either. Does this person go to a particular gym, golf course, church, restaurant or movie theater regularly? Even if you didn't get the invite, you can go too!



## CONSIDER ALL THE FACTORS

It can't be stressed enough that strategy is important to think about with these tactics. If you care at all about public perception in your campaign, think long and hard about what type of visit to pay someone. If you are worried about legal charges, make sure to have a plan to get out of there, or only plan on having the kind of fun that doesn't lead to long sentences if you are caught. It's important to keep your analysis of oppression alive when making someone's life hell; it doesn't help anyone to act out sexist, racist, or homophobic ideologies in attempts to intimidate, embarrass, or pester someone. There are plenty of ways to influence someone without turning into a jerk yourself.



Stop Huntingdon Animal Cruelty stages a home demonstration.



# >>> PRANKS

Knowing how to put one over on the bad guys and have a good time can balance all the meetings and hardships that we go through to get our work done. Having fun and being sneaky will have far-reaching and unforeseen effects for you and the people you work with. Some of these ideas might be light on legal foresight or logistical feasibility, but you can make your own choices, and these ideas might help you have a bunch more fun. It is important to approach this section with a healthy dose of optimism, patience, and a serious mischievous attitude.

Remember: glue everything shut, paint bomb all the cameras, follow the CEO's all the way home and then leave personalized messages all over their route. Chocolate ex-lax cookie your way into the office building, create a super soaker army and get it all on well-edited video. Stick it to the man and run. Here are a few pranks and tips, but really you just have to roll with your spontaneous creativity and intuition.

## **TIMING**

The comedic credo, "Timing is everything," is even truer in political pranks. You should never mess up timing at a demonstration and bring the heat down on everybody. If you screw up the timing you could ruin the efforts of a longer term campaign or message. And it has got to have a timely and funny delivery. The pressure is on. On a related note, a lot of this might go well with traditional civil disobedience type of action, but it also might not. Be careful how you combine things, and have a lot of fun.

## **IMPERSONATIONS, TRICKS, AND DISGUISES**

Candy Gram, Flower Delivery, Fake Committee to Congratulate for Whatever, the possibilities are endless. It might come down to what you've got in your costume repertoire. Lying your way inside instead of charging your way in is embarrassing for them and fun for you. In St. Louis, folks managed to disguise a lock down barrel as a huge potted plant. The only trouble security gave them on the way in was to ask them to use the freight elevator.

Try wigs, mustaches, cook uniforms, sexy maid outfits, or a clean pair of overalls. If you already have that, try really fancy clothes and infiltrate the nastiest jerks. A pressed, impeccably white jacket will often get you where you're going—no questions asked. Start collecting blazers and straight people clothes now—your shirt, skirt, pants or suit should be clean, ironed, and look like new. Accessories are important, should match your outfit, and be modest. Get your hair and nails done, shave,

and don't forget fancy shoes. And if you already have that down...who's side are you on, anyway? This is an underexploited group of tactics for getting in, getting your job done, and likely talking your way out.

### **ACT THE PART**

Know what you're doing there and keep it simple, even if it sounds stupid. Lot's of true things don't make sense. "I'm supposed to meet the super about some wall board." Believe you are somebody you're not. Never break character, no matter how busted you think you might be. Remember, the person you are lying to probably doesn't really know you aren't allowed there.

### **PIE-ING**

Pieing people is really fun. It is one of the most universally recognized practical jokes. Sometimes people try to take it too seriously though. You might want to try getting the hell out instead of waiting to see what kind of sense of humor people have.

The easiest way to build a pie is to squirt a bunch of whip cream on a paper plate. While cheap and easy to fold and conceal, they are hard to throw and therefore have to be delivered from closer range. Some pudding or custard in a lightweight aluminum baking tin is recommended for slightly longer distance delivery. If you're thinking of pieing someone who really needs it, it might be worth making a few and practicing, and/or having multiple pies and multiple pie-ers all serving it up from multiple directions and leaving in many directions, lickety-split.



### **CITIZENS ARREST**

You should get your own legal council about this—putting cuffs on someone might be a potential kidnapping charge, even in public and even if you don't stuff 'em in a trunk. Serving a mock-arrest warrant in the name of Truth and Justice, or Forbearance and Constancy might be a better idea.

## TURNING OFF THE GAS, LIGHTS, AND WATER

A pair of coveralls are a great companion to walking around trying to find breaker boxes or water or gas valves. Just put on your coveralls, and walk in like you are bored but you own the place. If your goal is turning off the lights, remember where you are so you can leave in the dark, or maybe bring a flashlight. When you find the breaker box, something that you want to turn off might be labeled on the key on the inside of the door, or maybe just flip the big switch and turn the whole 'effin place off. Think about stealing the fuses right out of the box. Then leave, or do something funny or weird or awesome.

If you want to turn of the gas, go out back and look for some pipes and a smallish grey box (about 2 feet tall). On one pipe, there will be a nut that you can turn with a wrench. Give it a half turn, so that the bar is 90° from where it started. Now the gas is off. If it's a restaurant they might not even notice until a half hour later when the fryers are getting cold; an office building in the winter might not figure it out for hours after slowly getting colder and colder.

Water shut off valves are beneath a metal plate in the ground, usually in front of the building. You need a special tool called a "curb key"—that they have at most hardware stores. Good luck.

## HIGHWAY DEPARTMENT ROAD SIGN IMPROVEMENT

The big lit-up signs beside the highway with cautions of current road conditions or terrorist threat levels can say whatever you want. Get dropped off at one that you can stand behind without being seen. A flashlight with a red lens or some translucent red stuff on it is a good way to see without being seen as easily at night. Open the box attached to the back of the sign and adjust.

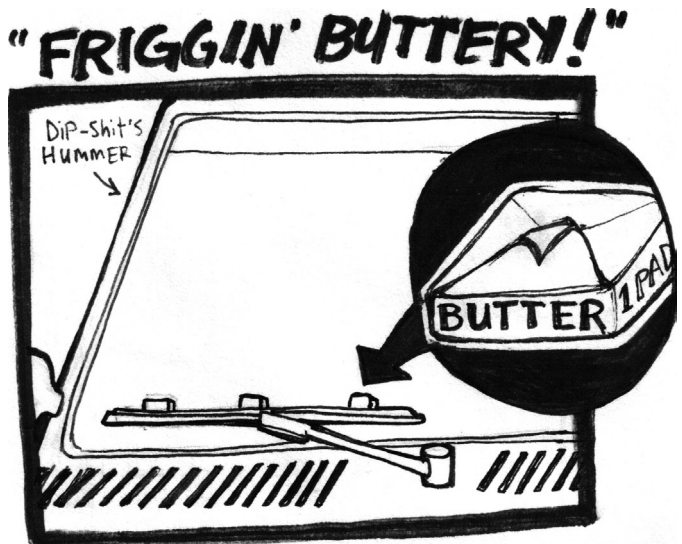

## STINK BOMBS

There are several varieties of stink bombs you can create, all of which are cheap and effective. If you don't want to make your own, they are still sold at fireworks stores, some toy stores, and all over the good ole internet.

## DIY STINK BOMB

### INGREDIENTS *-they're wicked cheap:*

- Sulfur, from rose dusting (an insecticide)
- Sulfate of ammonia (a fertilizer)
- Hydrated lime
- Water
- A cloth filter or an old t-shirt cut open
- One or two buckets
- A half-gallon or larger pot
- A funnel, optional

### DIRECTIONS

1. Mix 4 oz. of sulfur and 8 oz. of hydrated lime in the pot.
2. Add a quart of water. Heat while stirring continuously until the sulfur has completely blended. The hydrated lime will sink to the bottom of the pot.
3. Pour the yellow liquid off into a bucket.
4. Add 1 lb. of sulfate of ammonia and stir it a minute. Now it stinks.
5. Cover the bucket with plastic wrap and let it set for about a half hour, then pour off the liquid slowly through a cloth filter into a bottle. The liquid is vile, but it is not poison.
6. Apply with water gun, wet rags, or whatnot.

*The rose dust and the sulfate of ammonia can be purchased in the garden department of a home improvement or hardware store. Hydrated lime is obtained in the building section with the cement and similar materials. Try to do as much of this outside as possible or maybe just in your roommate's room. You can also buy some Butyric Acid. It stinks all on its own, and despite the name is entirely harmless.*

# CRITTER BOMB

## INGREDIENTS:

- 1 quart mason jar
- 1 small dead animal, or piece of dumpstered meat
- Water, Milk, Tahini
- Duration: 1-6 weeks depending on temperature and ingredients

## DIRECTIONS

1. Put the critter in the jar. The nastier the better because the decomposing action is what activates the prank.
2. Fill the jar halfway with water and screw the lid down tight. You can also add milk, tahini, or whatever else you want to make it gross.
3. Put the jar in a drop ceiling, in the back of a cabinet or a large drawer, in a heating/cooling vent or other out-of-the way place.
4. Leave.

## ADDENDUM

Don't waste all the pranks on the bad guys. Practicing them on each other is not only excellent bonding ritualification, but also puts you in the mindset to be a kick-ass tricky person.



Judicious use of valve stem removers incapacitates a coal truck in Carbo, VA, 2006

# >>> PAINT BOMBS

So you want to be the new Van “get up and” Gough? Or maybe you think, “Hey, climbing up billboards and altering them by hand seems like a lot of work. Do you have any other ideas on how to deface these monuments to consumerism?” A popular alternative is to launch a projectile filled with paint. Remember that billboards are a common target for these gems, but get creative. Use ‘em on corporate logos, office windows, or cars. Your options are limitless.

- + **Wicked easy to use, make and deploy**
- + **Versatile; use ‘em for oh so many applications**
- + **Made ahead of time; no risk of getting caught with spray paint on your trigger finger**
- + **Small window when you could be seen breaking the law**
- **You have to make ‘em ahead of time**
- **Very easy to make a very noticeable mess in your bag; they are fragile**
- **Can be difficult to hit a small target or area**

## **PREPARATION TIME:**

An hour or two, depending on how many you are making

## **MATERIALS NEEDED**

- **Light bulbs or x-mass bulbs or water balloons**
- **Paint (Make sure its the right viscosity)**
- **Hack saw or a pair of needle-nose pliers**
- **Duct tape or candle wax. If water balloon method is be used, you may need a lot of wax**
- **A funnel or something similar**
- **You may want to have a tarp or some newspaper down for spills**
- **Latex gloves or equivalent**

First things first, think about forensic evidence; wear gloves and wipe down bulbs with rubbing alcohol for prints. They don't always break and glass shards can carry finger prints. A tarp is nice for keeping the build area clean. House paint will work, but it is thick and will confine itself to a small splot. You'll want to water it down—provided it's latex based and not oil based—just enough so that the paint is still opaque but less viscous, ensuring that it will drip and run freely. Two parts paint, one part water should do. Try any other type of paint that you are confident will cover sufficiently.

Light bulbs and glass x-mass ornaments are the most appropriate vessels used in this process. Keep your eyes peeled for glass Christmas ball ornaments; this will reduce the number of steps in the process because the bulb already has an opening. The most common incandescent light bulbs act as a good projectile, and a hole can be made in a couple of different ways.

If preparing a light bulb, use a hacksaw to cut a half-inch off the metal end of the bulb, making sure not to sever it completely. You'll want to leave the end hanging by just enough metal so that it can be bent open, then closed again after you add your paint. If you haven't got a hacksaw, you can use a pair of needle-nose pliers to break away the black enamel insulator ring at the metal end of the bulb. Grip the nipple at the very tip with the pliers, and give it a tug to pull the filament out.

You can now fill the bulb with paint up to a half-inch from the top. Use a funnel or a piece of paper rolled into a cone to pour the paint mixture into the bulb. Tape over the end of the bulb or use a candle to melt candle wax over the hole, filling the remaining half-inch.

With the water balloon method, paint viscosity is again important—the thinning method above will work. Fill balloons with paint using a funnel. Don't over fill balloons as they may burst. Heat a pot of wax—a double boiler is recommended—until the wax has melted completely. The pot may not be usable for other purposes after being filled with wax. Carefully dip a paint filled balloon  $\frac{3}{4}$  of the way in to the wax. Tie off the balloon opening and dip the top in the wax. A nice  $\frac{1}{8}$  inch to  $\frac{1}{4}$  inch coating of wax covering the balloon will help with transport and breakage. Make sure the wax is not so hot that it will pop the balloon on contact. Some research and development may be needed to ensure proper breakage and safe handling, so do some testing before deploying in the field.

Hitting the mark can be hard. You may want to start with targets close to ground level. An accurate throw can be very effective, covering up focus points like faces or words. If you have a target that is higher, you could try finding or making a water balloon launcher. The launcher acts as an oversized slingshot, made from a five-foot piece of rubber—a bicycle tube would work for this—with an added pocket in the middle to hold the projectile. Two people hold the rubber at each end, and a third person pulls back on the pocket and releases. The paint bomb is then, hopefully projected skyward. Although this can be a much more conspicuous operation than simply tossing a paint bomb by hand, your attainable targets increase with your added range.



For pragmatic reasons, paint bombing is often a preferred tactic among “restoration” activists. The target image is effectively ruined quickly and easily, making for a relatively low-risk situation. With waysides as galleries and car-stricken people as captive audiences, what are you waiting for? Get to painting.

## HOW TO MAKE A MARKER!



**STEP 1:**  
 Find a cylinder w/one closed end (like a pill bottle), some ink or enamel (add paint thinner for drips) and thick felt (like from a chalkboard eraser) and some scissors.

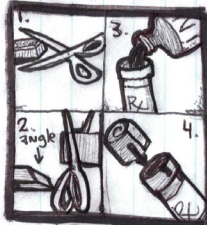

**STEP 2:**  
 Cut up eraser, felt etc. to 1 1/2 inch strip w/angled ends. Roll up tight & stuff open end w/ 1/2 inch poking out.



**STEP 3:**  
 While waiting for ink to bleed through felt, plot & conspire your deed.



**STEP FOUR:**  
 seek and destroy.

# >>> MISCELLANEOUS DEVILTRY

## GO KNIT A FOREST

Simple yarn may not be your first thought when deciding how to mess with the industrial might of a chainsaw—but maybe it should be. When yarn is cut with a chainsaw the fibers quickly get tangled in the chain and gears. It's a real time consuming pain to remove from the saw. Getting the yarn off the trees is also a bummer—someone has to use a knife or scissors to cut each piece off.

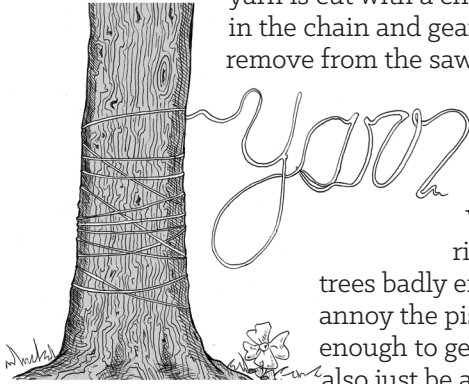

While the loggers will eventually get rid of the yarn if they want to cut the trees badly enough, this can be a great tactic to annoy the piss out of them, or slow them down enough to get your other blockades set up. It can also just be a fun time with friends even if it's not

part of a campaign. So head on out and get some balls of yarn and go for a run around your nearest threatened forest, or wrap your next slash pile with yarn, or put it on the next tri/bi/mono-pod you put up. Remember, that yarn isn't just for the crafters.

## DEBRIS PILES

Another fun and easy way to stop traffic for awhile, hopefully without getting arrested, is to pile up a bunch of stuff in the road. Logs, rocks, old couches, flaming dumpsters—flaming anything really—junked cars. Let your imagination run wild. If you make a mixed medium pile of stuff it will be harder to remove. So instead of just piling up some logs and sticks, wrap a bunch of yarn around the whole thing, or maybe barbed wire—or both. Cement some vertical logs into the road, and then build a slash pile around them. Make more than one pile along the road leading to what you are protecting. Keep in mind that the jerks have bulldozers so what takes a long time to build doesn't always take forever to get rid of—but it can still be both an inspirational image and a useful short-term blockade.

## TRUCKER FUCKERS

Sometimes a slash pile or blockade of boulders just isn't enough. Or maybe you're working in an environment that doesn't have a bunch of downed trees available to make a slash pile. Enter the Trucker Fucker. These devices are brightly colored, 5 foot metal poles, housed in a custom steel tripod sleeve, that are embedded in a road and are intended to stop any vehicle for a short amount of time. Trucker Fuckers are not

intended to catch drivers by surprise and cause an accident, but rather be a well marked pain in the ass that needs to be dealt with, often buying another blockade more time. Design your Trucker Fuckers to visually stand out and install them behind a small blockade of slash or rocks, ensuring that a vehicle will not speed into them. Fluorescent flagging is an excellent addition.

Construct the Trucker Fucker's sleeve from three, one-foot long, three to four inch diameter, schedule 40-60 thickness pipes which are cut and welded together in the shape of a tripod apex, with the intersecting pipes laid over one another. This should look similar to a regular tripod that is lashed together using rope—see **Tripods**. Use three slightly narrower in diameter pipes or bars, around five-feet in length, to fit through the sleeve and be embedded two-feet in the road. The bottom ends of these pipes should be cut at a sharp 45 degree angle

to penetrate the road. These pipes are also cut open at various spots along the bottom two-feet to create barb-like holds that will resist pulling once driven into the road. Brightly color the device and attach flags, streamers, or a banner.

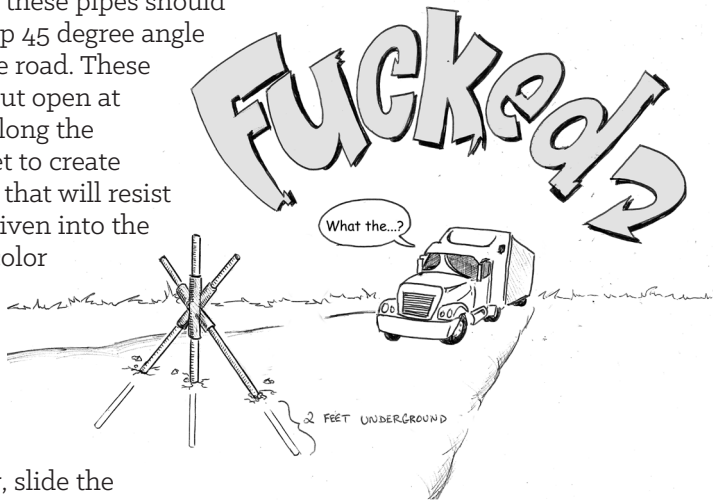

To install the Trucker Fucker, slide the pipes into the tripod sleeves one at a time and use a sledgehammer to drive them two-feet into the road. Beware that this will be loud. The finished product should be three feet high off the ground. Post holes can also be dug for the pipes and filled with quick set concrete for extra reinforcement. For a deluxe model, set the pipes in an entire trench of concrete.

### **GET RID OF THE ROAD**

In addition to making a pile on the road, you can remove part of some roads entirely. If you are working to blockade a dirt or gravel road you can fairly easily dig up large sections of it. The method for removing the road will depend on the amount of time you have. If you are planning to dig up part of a road all you need are some tools, time and trusted comrades. Grab a few pick axes, shovels, and digging bars and have yourselves a night of revelry. Each blister you get is one blister closer to winning!

Although it takes longer, when given free reign, water is a great destroyer of roads. Look for existing culverts and either plug them with debris to allow the water to flood and wash away the road; or, better yet, dig up the culvert and help the process along. It might take you an entire night to excavate a culvert—but the stream you free will then be able to wash away a huge section of the road.

Similar to slash piles, the more trenches you dig the better. Don't leave any piles of dirt or debris beside the trench because workers will just use it to fill in the trenches. Be strategic with which sections of the road you decide to rip up—it's a sad day when they just cut a few trees and drive right around all your hard work. It's also necessary to think about the depth and breadth of your trench.

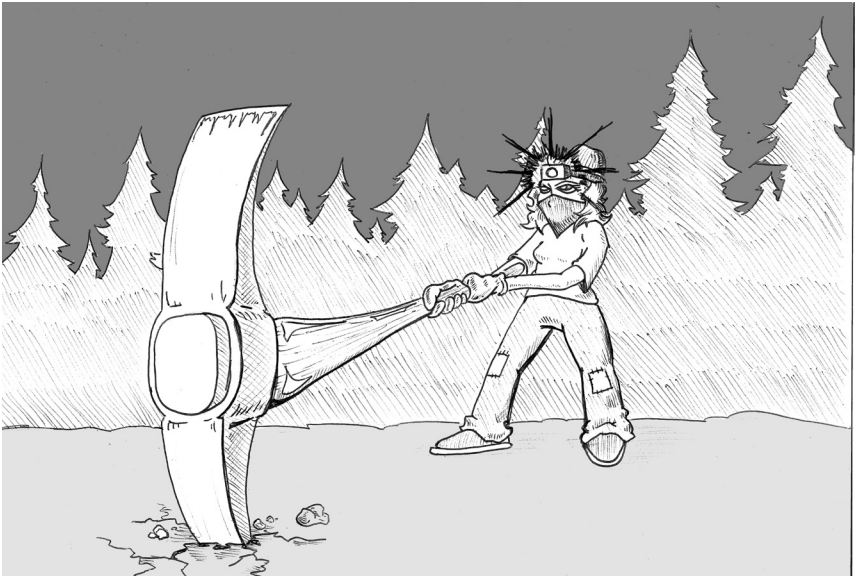

## DISABLING TIRES

If you don't have the time and tools to dismantle the road, a quick way to still stop vehicles is to flatten their tires. There are several options to consider:

### Caltrops

Four-pointed metal devices that always have a sharp point aimed skyward and are easy to strew about a road. Caltrops can either be purchased—keep good security in mind and only make purchases in a fashion that preserves your anonymity—or you can make them at home with a few common tools. Lots of survivalist types buy and sell them in preparation for the New World Order.

With a welder and grinder you can sharpen the head of a nail, weld 2 together, and bend them 90° around each other.

If you don't have those tools lying around, you can use sheet metal (about 2mm thick) and tin snips. Cut a rectangle of metal that is 2 ½" by 1 ½", then on each of the short sides cut out a v-shape. With pliers just bend the corners opposite from each other about 45°.

### **Valve Stem Removers**

Most vehicles don't use inner-tubes in their tires, and the valve to air them up is just tightly fitted into the rim itself. Auto parts stores, even Walmart, sell the tool used to install and remove the valve stem—it's usually about \$10. There are 2 types—one that removes the entire rubber piece, and one that unscrews the metal bits on the inside of the stem.



Being able to quickly let the air out of tires without actually damaging them (like slashing them through the un-patchable side wall does) can be a big help if someone is going to lock down to the vehicle. This can greatly reduce the stress of wondering if the driver is going to stay stopped while someone is attached. However, it's best to beat a hasty retreat if you are the one who just deflated the tires.

### **Pebbles**

Putting a pebble under the cap of a valve stem takes a little more time to deflate the tire, but it's a little more hilarious and easy to accomplish. Get a small stone, unscrew the valve cap, wedge the stone against the pin so that air starts to escape, screw the valve cap back on to hold the stone in place. It's like the easiest, ever right? Why not just go out for fun and start deflating the tires on every Hummer you see? Or get the cop cars the night before an action to seriously delay their arrival time.

## **CLOSE THE DOORS**

Gates and doors are ready made barriers—all you have to do is lock them shut, or disable the lock that's already there.

### **Cement and Glue**

If the keyhole is accessible, you can jam it with some small pieces of wood or paperclips, and then superglue it to make sure a key can never go in it again. If it's a gate with a welded lock guard on it, you can fill the guard with cement. Mix some quick set concrete on-site in a plastic bag until it's nice and thick and lumpy. Cut some slits all

around the bag so it can leak out a bit, and cram it into the lock guard. Then add some duct tape on the bottom to hold it all in place. Make sure the concrete fills the whole lock guard, and punch some holes in the duct tape for air flow.

### **U-locks, “The Club”, Chain**

Faster than gluing or jamming a lock, is to just add your own to the entrance. U-locks have been used to hold fence gates shut, and on double doors when the handles are close enough together. If the handles are too far apart, you can use the anti-car theft device the Club. If the distance is too great for the Club, use a chain and padlock. Make their day even worse by jamming or gluing your own lock if you have the time.

### **SPECIAL DELIVERY**

There are plenty of things that can be brought, sent, or left behind at any location you are targeting. Is it a corporation that’s clearcutting the forest? A load of stumps blocking their office doors or parking lot entrance could slow down the operations. Does their business make you sick? Consider hosting a puke-in. Get a hold of some ipecac or do whatever you need to puke on command. Does their business stink? Maybe a load of manure on their doorstep will make them aware of that fact. What else could you leave that is stinky, annoying, or hard to remove?

### **POO PERSON**

Lots of direct actions include situations where if only there was one final deterrent to keep the police from arresting everyone—the forest or the day or whatever—would have been saved. If you find yourself in this situation, look no further for a time tested method to make sure no one wants to touch you ever again.

The tactic of wiping poo on yourself has been known to deter the police quite well in past campaigns. Someone single-handedly blockaded a road for a day that hundreds of folks tried to block during an anti-nuclear protest in the late 70’s, simply by smearing themselves with poo. That same person also occupied a pod which blocked a forest road in BC, Canada for three full days, even though the pod was only about 40’ above the road, because the cops had no idea how to grab him and put him in the cherry picker. He escaped that situation in the end too. Here’s the basic idea. Take some of your own poo, and wipe it on yourself. That might sound unsanitary. Well it is. That’s the point. No one wants to touch someone with shit wiped all over themselves. It seems straight forward but there are at least a handful of things to think about first:

- >> How will this affect the police tactics against you and others involved who may not have made themselves so hard to touch.
- >> How will this affect the media spin.—they will DEFINITELY focus on this.
- >> Make sure to wash hands and make sure that there is no poo on your face or areas that may be near your mouth.
- >> Remember when poo dries it can flake off. If you aren't excited about dysentery keep those flakes out of your water.
- >> Has the situation escalated to this tactic? Don't rush using this one. It could hurt your campaign if used in an untimely manner.
- >> This tactic can be especially useful when in pods or treesits since extraction is already very difficult.
- >> Eat some prunes, have some fun, and wash your hands.

### **POLITICAL EVENTS**

While it might be hard to stomach, staying on top of who is running in elections can really help narrow down who to target. Pay attention to advertised events, or look them up on candidate websites, then start inviting people. Make fliers advertising free food and drinks at the location of their next fundraising dinner. Post the fliers around town, put the event on Craigslist and in the local paper, and get the radio to announce it. If they aren't hosting any dinners soon, just put down the address of their busy campaign office—a host of soon to be angry people will certainly slow down their work.

### **GUERRILLA THEATER**

Stage a mock trial in front of the courthouse, have a press conference with some “billionaires for coal” at the Peabody office, or act out who the local senator is “in bed” with in front of their office. The possibilities are endless. Get your drama team on, and ham it up good. Guerrilla theater is a great way to have a little fun while educating people about your issue. It's also more likely to get you some media attention than holding a few signs on the street corner.

### **BALLOON BANNERS**

Messaging is often key with actions—and getting your message out while getting away can be quite useful. Even more useful still is having your banner be out of reach so plenty of people can see it long after you're gone. Balloon banners are a great way to quickly release a banner in any high ceilinged building.



The easiest way to ensure that your banner can go up without a hitch is to have a super light banner, and a bunch of balloons. Paper is great; sometimes print shops or paper distributors will throw away or give away the butt end of a roll. Tape a dowel across the top and bottom of the banner. This will hold the corners out, and give the bottom some weight. Balloon banners are easily deployed when rolled up, and as the balloons lift it out of reach the banner unfurls. Slightly more weight at the bottom can help make sure it totally opens.

A 12" balloon can lift about 14 grams—around 30 balloons per pound—so just do the math after you weigh your banner. Bigger balloons can lift more, check out [heliumcalculator.com](http://heliumcalculator.com) to decide how many balloons you need. Most party stores and even grocery stores sell helium-filled balloons, some will fill balloons you bring in either cheaply or for free. Tie an equal number of balloons to each top corner of the banner, and you're ready to go.

**For some added fun:**

>> Get a couple "Happy Birthday" balloons to add to your disguise when buying balloons and when entering the building. "Just heading up to Mary's office to surprise her on her birthday, officer...Yes, her favorite colors are green and black."

>> Buy a personal alarm or "screecher," usually about \$10-15, to make your banner more noticeable. When the pin is pulled out it makes an earsplitting shrieking noise until the batteries run out. Get several and send them up on balloons independent of the banner.

>> When rolling up the banner add a generous amount of glitter. As it unfurls the glitter will rain down on everyone below. Even if they are upset about the banner, who doesn't love glitter?

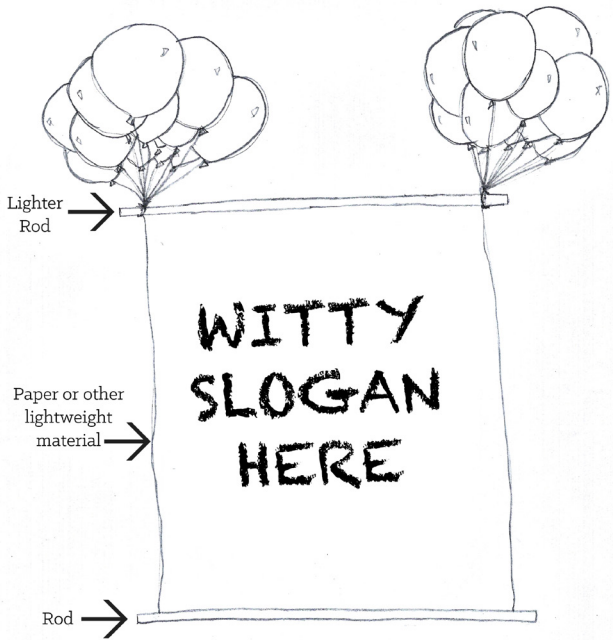

# >>> CONCLUSION

It is encouraging that just as furiously as corporations and governments are destroying the Earth, people from all walks of life are courageously putting their bodies on the frontlines of the war on nature. Communities are boldly moving themselves to defend the Earth with creative forms of direct action, using tried and true tactics while also innovating new, dynamic means of resistance.

Currently, hillbillies in southern Appalachia are blockading mountaintop removal sites with nothing but their bodies while tribal members and EF!ers in the Northern Rockies are locking themselves to megaload container trucks hauling tar sands refining equipment to Canada. In Chicago a working class Latino community has waged a successful direct action campaign to shutdown two coal plants that were poisoning their neighborhood. While the hackers of Anonymous infiltrate corporate and government computers and expose their corrupt activities, EF! activists are deploying treesits (traditionally used to protect forests from logging), to shutdown natural gas fracking sites and coal mines. Meanwhile, immigrant youth in Arizona are using lockboxes, which were developed by environmentalists in the 80's, to block buses deporting their families, and global justice activists are using tripods to block international trade negotiations in DC.

In Turkey, what started as a protest to defend Gezi Park—one of the last greenspaces in Istanbul—from being bulldozed for a strip mall, turned into a nationwide uprising that nearly brought down the government. In Romania, farmers have joined forces with urban activists to occupy a Chevron owned frack site, at times destroying equipment and clashing with the police. In China, thousands of people angered at a plan to dump toxic waste into the sea, ransacked government buildings and overturned cars to express their outrage. Meanwhile, in Brazil, Amazonian tribes have joined forces to dig a hole in the Belo Monte dam, a massive project that would flood the land that has sustained them for thousands of years. In New Brunswick, the Elsipogtog people have successfully forced SWN Resources off of their land in a battle that has seen everything from their tribal chairman sitting in front of fracking equipment to masked militants torching police cars.

Our means of resisting this ecocidal culture and the movements that fan the flames of this resistance, are as diverse as the ecosystems of the planet itself. This manual is just scratching the surface of what is possible in engaging in effective defense of the land. We hope it is a start,

a jumping off point that shares the decades of experience in ecodefense that EF! has developed, while leaving room to explore, experiment and escalate new forms of resistance.

As we embark on this journey of resistance, we must not lose sight of how we treat each other. It is imperative that our actions are carried out in a manner that challenges all forms of privilege and oppression while promoting mutual aid and solidarity. It is hard work, but well worth the effort when wounds caused by colonization, racism, classism, sexism, and other forms of oppression begin to heal and we are able to join together in struggle with full trust in each other.

Direct action gets results. Tens of thousands of acres of forests, prairies, swamps and deserts have been protected, power plants canceled, political prisoners freed, companies put out of business, scandals exposed, mountaintops saved from blasting, animals freed from traps, and governments toppled because people got together and took uncompromising direct action to get what they wanted.

So what are you waiting for? Do your research, rustle up a crew, make a plan, do a practice run, use good safety and security, and do the DAM thing.

For the Wild!

**- THE DAM COLLECTIVE**

# >>> GLOSSARY OF TERMS

**AFFINITY GROUP—AG:** A group of individuals, often with each individual having a specific role/roles, working closely with one another, to achieve a shared goal. Affinity Groups may be formed for one time actions with folks that have just met at action camps or could be comprised of lifelong friends that have worked together for years. It's also common for multiple Affinity Groups to work together.

**ARMORING:** A combination of nails, chicken wire, yarn, tar, granite chips, barbed wire, etc... that is used to inhibit or hinder the dismantling of lockboxes and structures such as tripods

**ATC :** “Air Traffic Controller,” the most common type of belay device used in rock climbing and gaining popularity in direct action circles

**BODY BLOCKADE:** A blockade using only your body/bodies, used for it's quick deployment and mobility

**BOSUN'S CHAIR:** A small board that is suspended by ropes that a person can sit on

**BOTTOMLINE:** When someone chooses to be responsible for seeing that a certain project or aspect of a project gets done

**BURNER PHONE:** A prepaid cell phone that has no contract with a phone company, thus no name attached to it. Excellent for maintaining anonymity

**CHERRY PICKER:** An articulated boom lift that is often a tool used to extract treesits and pods

**CIS:** When an individuals' self perceived gender matches that which was assigned to them at birth

**COLONIZATION:** The spread of western culture and overthrow of indigenous communities

**COME-ALONG:** A portable winch that can be used in place of people power for erecting structures

**CONSENSUS:** A form of group decision making designed to seek consent of all participants

**CURB KEY:** A “T” shaped tool designed to access water shut-off valves that are below ground and turn them on or off. Available at hardware and plumbing supply stores

**DE-ARREST:** When an individual or group is able get a person who is being placed under arrest out of the hands of the police, usually by physically grabbing the person back

**DEAD MAN ANCHOR:** A type of anchor using two pieces of rebar hammered in the ground at opposite 45 degree angles

**DIAMOND GRINDER:** A high speed grinder equipped with a special blade that rotates at 10,000 rpm’s or more. Used to by police and fire departments to cut through metal objects such as lockboxes and U-locks.

**DUNKER:** A type of platform in which one side will drop if the support lines are removed, dumping the sitter.

**DRY RUN:** Practicing until your group is comfortable with a deployment of an action

**DYNAMIC ROPE:** Rope designed to have about 6.5% stretch when loaded, typically used for lead climbing or situations in which a climber is more likely to fall more that a few feet

**EARTH FIRST!:** A movement with three main tenants, direct action, bio-centrism and no compromise. We believe in using all of the tools in the toolbox, from grassroots and legal organizing, to civil disobedience and monkey wrenching

**FLASH MOB:** Using text message loops to coordinate multiple groups quickly descending upon a target

**FREDDY:** Forest Service Officer

**FREE STATE:** Long term occupations and blockades where temporary communities are built and lived in as a part of the protest

**GENDER:** One’s sum of masculine and feminine qualities as defined by themselves

**TECHNICAL BLOCKADE:** A lock down that uses equipment such as locks, barrels or lockboxes, usually intended for longer term occupation

**HARNESS INDUCED PATHOLOGY:** loss of consciousness due to lack of blood flow while remaining suspended and still in a harness for an extended period of time

**JAWS OF LIFE:** A very powerful hydraulic cutting tool usually used by fire departments and rescue squads to cut people out of wrecked cars and collapsed buildings. Sometimes used to cut activists out of lock down devices

**JEWELRY:** slang for the chains you use to attach yourself to a lockbox

**LEO:** Law enforcement officers

**LOCKBOX:** A tube made of either plastic or metal that is used to lock people together, or lock people to objects.

**LOCK DOWN:** When an individual or individuals immobilize equipment or restrict access by attaching themselves to an object or other bodies, possibly using equipment

**PERSONAL FLOTATION DEVICE:** a piece of equipment designed to assist a wearer, who may be either conscious or unconscious, to keep afloat. Examples include: life jackets, life vests, life preservers, and floatation suits

**POINTS OF DECISION:** The places/people who call the shots: corporate offices, senators, industry meetings, etc.

**POINTS OF DESTRUCTION:** The places where impact is most direct: mining site, polluted community, timber sale, etc.

**POINTS OF INTERVENTION:** Places in a system, be it a physical system (chain of production, political decision making, etc.) or a conceptual system (ideology, cultural assumption etc.), where action can be taken to effectively interrupt, challenge, and hopefully change, the system and the story about it

**POLICE:** An evil form of human. similar to orcs in lord of the rings

**POWER MAPPING:** Determining who has the power to give you what you want and what it's going to take to influence them to do so

**PRIVILEGE:** A special advantage, immunity, permission, right, or benefit granted to or enjoyed by an individual, class, or caste

**PROGRESS CAPTURE:** A device or knot that will allow rope to move unidirectionally, can be made from smaller diameter rope

**REBAR:** Short for reinforced bar, a ribbed steel bar used in construction

**RIGGER:** A person who “rigs”, builds or sets any aerial structures or climbing ropes

**RUNNING END:** The end of a rope that is active when tying a knot

**SCREW LINK:** A steel, oval shaped device that opens on one side with a screwed gate, available from hardware stores. Screw links with an adequate weight rating on the side are preferred when used for life support situations

**SECURITY CULTURE:** A set of customs shared by a community whose members may engage in illegal or sensitive activities to minimize the risks of subversion, or targeted by law enforcement or opposition.

**SIT:** When used as a noun, this describes a treesit or other form of aerial blockade. When used as a verb, this describes the action of occupying a treesit or other form of aerial blockade.

**SLASHPILE:** A heap of sticks, logs and other debris that are piled onto a roadway to impede access.

**SNATCH SQUAD:** A small team of police whose function is to enter groups of protestors and arrest targeted individuals

**SNITCH:** An informant who cooperates with the government, endangering activists around them

**SPOKESCOUNCIL:** A consensus based meeting model used for large actions and events. Affinity groups send spokespeople to the spokescouncil to make decisions about bigger action plans

**STANDING END:** The longer free end of a rope that is not involved in tying a knot

**STATIC ROPE:** A rope designed to have minimal stretch, typically used for ascending, rappelling, and hauling

**TACTIC STAR:** A tool used to determine the evaluating tactics before and after actions



**TEMPERATURE CHECK:** A quick way to show support or lack there of for proposals, usually a hand motion, up is support, down is against

**TEMPORARY AUTONOMOUS ZONE:** See *FREE STATE*

**TRANSGENDER:** An umbrella term used to describe gender variant people who have gender identities, expression or behaviors not traditionally associated with their birth.

**TRUCK ROPE:** Three strand polypropylene rope that comes in various sizes

**U-LOCK:** A bicycle lock commonly used in direct action context for locking ones body parts, specifically ones neck to objects

**UNARREST:** See *DE-ARREST*

**WORKING END:** See *RUNNING END*

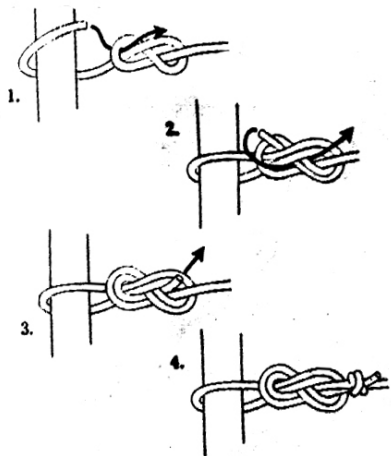
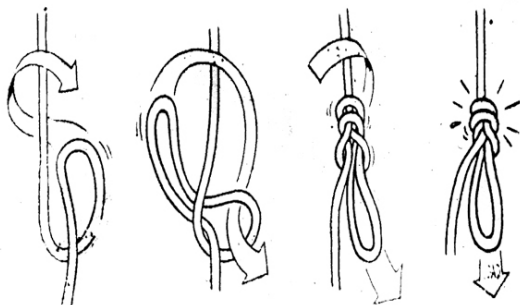

Figure 8 follow through



In-Line Figure 8

# KNOTS

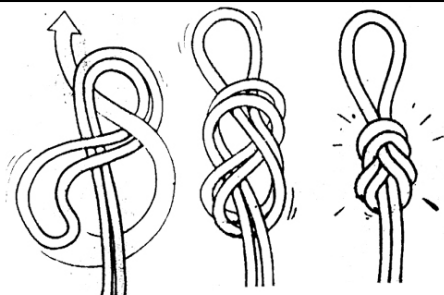

Figure 8 on a bight



Girth Hitch  
on a  
Carabineer



Properly  
faced  
Eight.

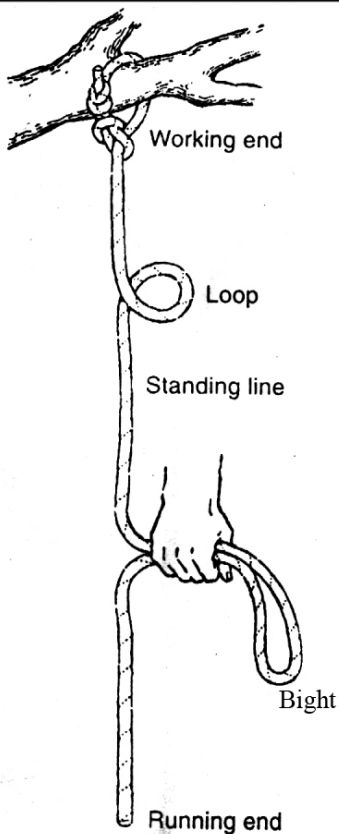

Parts of the rope.

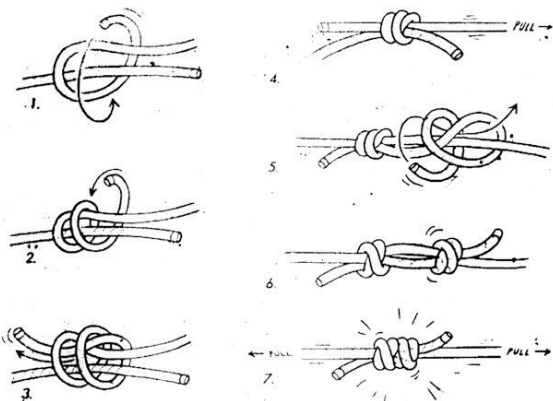

Double Fisherman

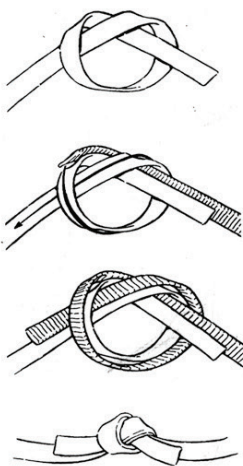

Water Knot (Ring Bend)

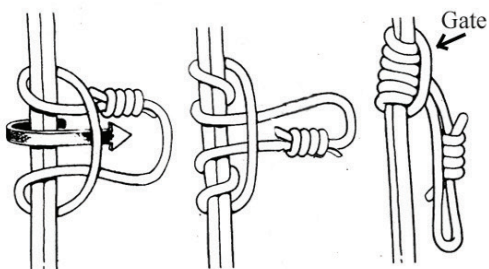

Prusik

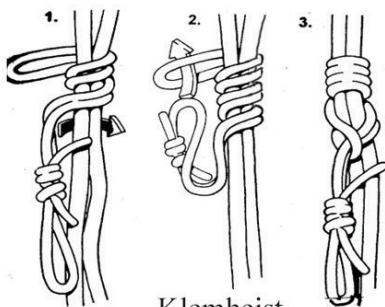

Klemheist

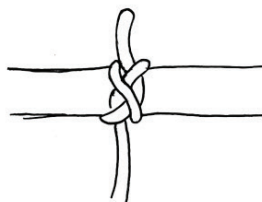
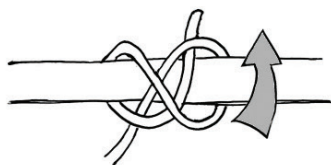
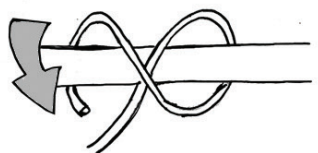

Constrictor Hitch

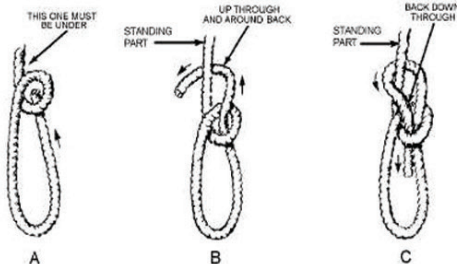

Bowline

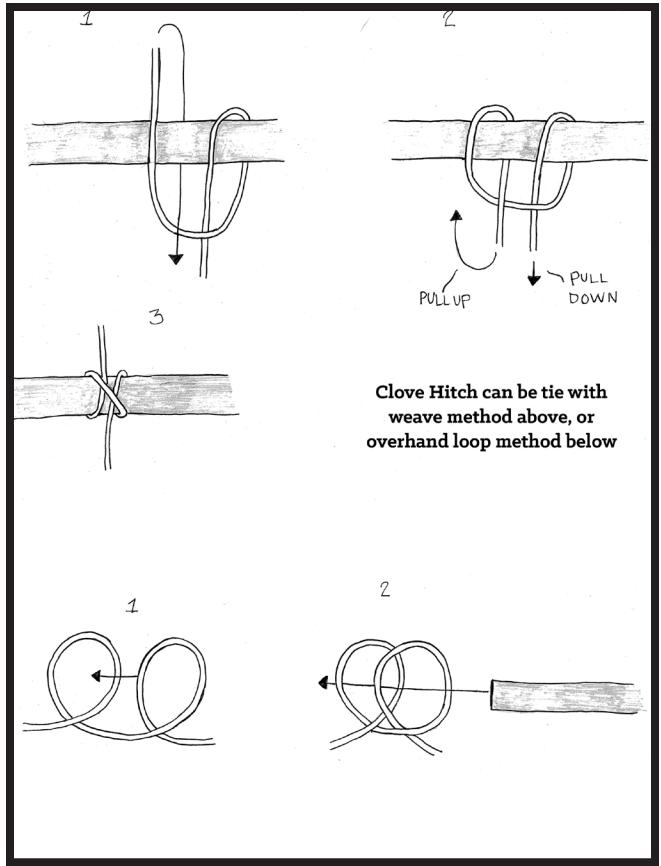

# >>> CONTACTS AND RESOURCES

## TRAININGS AND PRESENTATIONS

### **EF! Speakers Bureau**

Available for trainings in direct action skills, action planning, strategy, EF! history and more.

Contact: [speakersbureau@earthfirstjournal.org](mailto:speakersbureau@earthfirstjournal.org)

### **EF! Climbers Guild**

Hosts beginning to advanced climb trainings.

Check out: [www.efclimbers.net](http://www.efclimbers.net) for upcoming trainings.

Or contact: [efclimbers@gmail.com](mailto:efclimbers@gmail.com) about setting up a training

## ADDITIONAL DIRECT ACTION RESOURCES AVAILABLE AT:

[www.earthfirstjournal.org/directactionmanual](http://www.earthfirstjournal.org/directactionmanual)

**Anti-oppression and Ecoliberation**

**Starting and Existing EF! Groups**

**Climbing**

**Media**

**General Hooliganism and Chicanery**

**and more**

**Biocentrism**

**Blockades**

**Scouting**

**Consensus**

**Strategy**

## SUPPORT THE EARTH FIRST! JOURNAL

Stay up to date with exciting news and analysis from the frontlines of ecological resistance. Support independent media. Subscribe to the Earth First! Journal.

### **Earth First! Journal**

PO Box 964

Lake Worth, FL 33460

USA

(561) 320-3840

[www.earthfirstjournal.org](http://www.earthfirstjournal.org)

[collective@earthfirstjournal.org](mailto:collective@earthfirstjournal.org)

### **Earth First! Newswire**

Can't wait for that subscription to come in the mail? Keep up the the ecological struggle at [www.earthfirstjournal.org/newswire](http://www.earthfirstjournal.org/newswire).

## DIRECT ACTION MANUAL

To order additional copies of the EF! Direct Action Manual go to:

[www.earthfirstjournal.org/subscriptions](http://www.earthfirstjournal.org/subscriptions)

Send inquiries regarding the DAM to: [dam@earthfirstjournal.org](mailto:dam@earthfirstjournal.org)

# EXAMPLE OF AN ARRESTEE SUPPORT FORM

## AFFINITY GROUP ARRESTEE SUPPORT FORM\*

Goes to **Your Legal Support Person** and No One Else!

Legal support people should keep this form away from the action and in a safe place at all times!  
This is not privileged or protected information. It can be used by the cops if they get hold of it.

Full legal name \_\_\_\_\_ Nickname/Alias \_\_\_\_\_  
Phone \_\_\_\_\_ E-mail \_\_\_\_\_  
Date of birth \_\_\_\_\_ Current address \_\_\_\_\_  
Permanent address \_\_\_\_\_

The date I absolutely have to be done with the action/out of jail (if possible): \_\_\_\_\_

If I'm in jail overnight, I need you to (call my boss, water my plants, feed my dog, etc.):

\_\_\_\_\_  
\_\_\_\_\_

If I'm in jail, I need you to call (list when, for what, under what circumstances):

Name	Relationship	Phone number	Other Info
_____	_____	_____	_____
_____	_____	_____	_____

Watch my back while I'm in jail because (I'm transgendered, a minor, a non-citizen, a person of color, on probation, have an outstanding warrant...):

\_\_\_\_\_  
\_\_\_\_\_

If I have kids, these are my plans for taking care of them (or I need someone to):

\_\_\_\_\_

Medications and doctor's phone number (prescriptions attached):

\_\_\_\_\_

Health concerns or other special needs (medical conditions, allergies, dietary considerations, etc.):

\_\_\_\_\_

Vehicle (car or bike, description, license plate number, insurance info, location of keys, who can drive or pick up):

\_\_\_\_\_

Legal Strategy (for example, I want to get out ASAP, will refuse to give name or pay fines, will act in solidarity with affinity group or other arrestees, etc.):

\_\_\_\_\_

I am / am not playing a support role, such as legal or medic (circle one). If so, which role? \_\_\_\_\_

[Fill out after arrest/release] Trial info:

Hearing type: \_\_\_\_\_ Date: \_\_\_\_\_

\* This form is offered as a guideline for information you may want to share with your legal support before an action.  
Consult an attorney for legal advice.

# DIRECT ACTION TRAINING OUTLINE

The Direct Action Training Outline is a resource for folks who have been trained as Earth First! Direct Action Trainers and may be a useful comparison tool for folks who have been trained in other direct action styles. This outline includes many different sections that a trainer can pull from, depending on the length of the workshop and the participants' desires. As the trainer, it's your job to keep all participants engaged, and whenever possible, share stories you know well to illustrate your point. When planning your training, be aware of different learning styles and try to have varied activities that will speak to all types of folks.

Needed supplies may include: markers, flip-chart paper, snacks, tripod poles, climb rope, full set of climb gear, lockboxes, jewelry, u-locks, pens and paper for everyone.

When putting the training together, think about the needs of the participants. For instance, for a two hour introductory workshop for a group of people with varying levels of exposure and interest in direct action, you could do: Welcome, What is Direct Action, What Makes DA Effective, Affinity Groups, Action Roles, Action Scenario, Debrief. But for a two hour workshop preparing for an action the following day, you could do: Welcome, What is Direct Action, Affinity Groups, Action Roles, Listening/Fears Exercises, To Bring or Not to Bring, Hassle Line Role Play, Lock downs.

## SECTION IDEAS

- Welcome
- What is Direct Action
- Campaign Strategy
- When to Use Direct Action
- Escalation of Tactics
- Affinity Groups
- Roles in an Action
- To Bring or Not to Bring
- De-escalation/Hassle Lines
- Body Blockades
- Consensus
- Fears and Excitements



Device Blockades – lockboxes, u-locks, barrels, etc...  
Know Your Rights  
Tripods  
Action Practice

### **ACTIVITY IDEAS**

Spectrograms and Quadrants  
Role Play  
Active Listening  
Story Sharing  
Hands On Practice With Blockade Devices

### **EXAMPLE ACTIVITIES**

These are just a couple sections to give an idea of leading exercises rather than just dispensing information. Take and leave what feels good, including the quotes.

#### **Welcome (10 min)**

Trainers introduce themselves and give some background/personal experience. If the group is small enough, do a go around with names and “One thing you hope to get out of the training?” If it is too big for a go around, ask people to answer the question with the person next to them. Share the outline and goals for the training.

Establish ground rules by asking what group agreements people need to be able to participate and learn in the workshop—like raise your hand to speak, don't interrupt, move up/move back. The last ground rule can be something like, “Be okay with making mistakes. The only way we can learn from our mistakes is to openly receive criticism about them—in this training and in life.” After all ground rules are written up, have the group acknowledge and agree to help enforce each of them.

#### **Listening/Fears Exercise (10 min)**

Break into groups of two. Preferably with someone that might be your buddy for the action, or a direct support person with an arrestee. Have one person talk for one minute about things they are nervous or scared about regarding action. Allow 30 seconds for reflection from the buddy. Have same first person talk for one minute about things they are excited about for action. Allow 30 seconds for reflection from the buddy. Switch and repeat so the original listener is now the speaker. Do not do a full go around in large group, but ask for people to share if

they would like. Notice if most share about fears or excitements to get a sense of where the group is at with doing direct action.

### **Hassle Line Role Play (15-20 min)**

“Direct Action involves conflict. More likely than not, you’re gonna piss someone off.”

Split up the group into two parallel lines and present a conflict scenario.

Example: A beloved community garden in your neighborhood is about to get bulldozed by the city. One side is the people assembled to protect it, the other side is the city construction workers and police who show up to give you the boot.

Make it clear for people not to touch each other. Encourage people to take a moment to get into character, then act out the scene for about a minute.

Debrief. What worked for deescalation? Answers may include maintaining eye contact, giving the other person space, staying grounded, not interrupting, bringing someone out of the “hot zone”, lowering your voice so they have to match, sitting down. An important lesson to learn is to feel empowered to step in and not fall into bystander mode.

If some important concepts did not come up, try and tell a personal story that might include some of the following:

- >>Scan the group and figure out their leader. Find the person others are looking to.
- >>Find common ground with them. Make yourself human; make them human.” “You’ve got kids. Can I see your photos?”
- >>Don’t get isolated—stay in pairs.
- >>Don’t take anything personally.
- >>Stay aware of their hands and changes in their body language.

>>Deflect.

>>Stall.

Be intentional about gender, race, class and other identity characteristics.

Do the exercise again with a different scenario, utilizing the tools just talked about.

### **Action Scenario (20-30 min)**

Break into groups, and have the participants plan an action. Provide a context and a goal—like “your group has been fighting the construction of a pipeline in your neighborhood, and the company is about to start clearing trees for construction.” Provide a map of the area with multiple action targets, a list of accessible supplies, a sense of how many people they can plan for. Make it as interactive as you want—you can add a change in the context after 5-10 min, you can have a “scout” who asks the trainer for site information, you can give updates about police surveillance.

After 10-15 minutes for planning, play out the action scenario. Trainers can be police, media and workers to help the scenario move. Do your best to stay in character and make this a realistic experience for practice.

Debrief the mock action. Ask how the group felt taking action together. Allow some time to just reflect on what happened and how it felt. Get a little more info to help with future planning by asking further questions like: “What time of day/day of the week is your action?” “How will you transport people and supplies to the site?” “How will the different groups communicate with each other?” “What will you do if some police arrive while you’re setting up?” “What is the exit strategy?” “What else do you need to figure out/what holes are there?”

Just as furiously as corporations and governments are destroying the Earth, people from all walks of life are courageously putting their bodies on the frontlines of the war on nature. Communities are boldly moving themselves to defend the Earth and it's inhabitants with creative forms of direct action, using tried and true tactics while also innovating new, dynamic means of resistance.

The Earth First! Direct Action Manual puts you on the cutting edge of the environmental movement.

